

NEUATION



İSTIR OH PRIME

PRODUCT USER MANUAL

CONTENTS

1.	PRODUCT DESCRIPTION	1
2.	INTENDED USE	1
3.	SYMBOL	1
4.	FEATURES	1
5.	ACCESSORIES	1
6.	TECHNICAL SPECIFICATIONS	1
7.	SAFETY PRECAUTIONS	2
8.	MAINTENANCE & CLEANING	4
9.	INSTALLATION & OPERATION	4
10.	TROUBLESHOOTING	8
11.	WARRANTY STATEMENT	8
12.	PRODUCT DISPOSAL	9
13.	IMPELLER TECHNICAL SPECIFICATION	10



1. PRODUCT DESCRIPTION

The overhead stirrer is designed to give homogeneous mixing of the sample. It comes with IP protection class (IP 54), variable speed & timer setting, Large LED display and CW/CCW mixing. Its has smart control feature which ensures the constant mixing of highly viscous solutions.

2. INTENDED USE

Applications include dissolving solids in liquids, mixing liquids in liquids, stirring of volatile solutions & other homogenous mixing.

3. SYMBOL

 Warning	 Waste electrical
---	--

4. FEATURES

- Brushless DC motor for quiet operation and maintenance free long life
- Microprocessor controlled stirrer with variable speed and time setting and along with last run memory feature
- Adjustable speed in steps of 1 RPM
- Timer ranges from 1min to 99 hrs 59mins & continuous(infinity)
- Clockwise(CW)/Counter clockwise (CCW) motion
- IP 54 compliant design
- Corrosion resistant SS impeller

5. ACCESSORIES

A. Power adapter B. Plate stand, Chuck, Boss head clamp and Impeller (optional)

Note : This user guide is intended to assist with the operation and care of the unit only and not for its repair. The customer should not attempt to service or repair the unit. If repairs are required, please contact the supplier.

6. TECHNICAL SPECIFICATIONS

Model	OH 8 Prime	OH 15 Prime	OH 20 Prime	OH 40 Prime
Stirring quantity (H2O)	10 L	20 L	25 L	40 L
Max. viscosity (mPas)	4,000	8,000	10,000	30,000
Max. torque at chuck (100 rpm)	8 Ncm	15 Ncm	20 Ncm	40 Ncm
Speed range (RPM)	90 - 2000	50 - 1000	90 - 2000	50 - 1000
Speed step	± 1 RPM			
Speed accuracy >500 RPM	± 1 %			
Speed accuracy <500 RPM	± 5 RPM			

Model	OH 8 Prime	OH 15 Prime	OH 20 Prime	OH 40 Prime
Deviation of speed measurement <100 RPM	± 30 RPM			
Timer range	1 min - 99 hr 59 min & continuous.			
Display	Digital (LED)			
Reversible direction of rotation	Yes			
Power Intermittent operation	yes, (Resumes from left parameters upon resumption of power)			
Chuck range	0,7 - 10 mm			
Protection class	IP 54			
Protection	Overload, overcurrent, overtemperature			
Dimensions in (W x D x H)	176 x 173 x 79 mm			
Net weight with chuck	Approx. 1.7 kg			
Ambient Temperature	5-40°C			
Permissible Relative Humidity	≤80%			
Power Adapter Detail	Input: 100 - 240VAC, 50/60 Hz Output: 24V  1.5A			
Power Consumption	36 W			
Altitude	Use upto an altitude of 2000 m above MSL			
Pollution Degree	2			
Environment	For indoor use only			

7. SAFETY PRECAUTION



Read all safety & usage information provided in this manual carefully before using the device.

- The users must make ensure that the OFF switch of the device can be accessed immediately, directly and without risk at any time all the time.
- Ensure stable assembly. The vessel used for stirring must be secured.
- Remove the chuck key from the chuck before turning the device on.
- Imbalance of the output shaft, the chuck and in particular the stirring tools can lead to uncontrolled resonant vibrational behaviour of the device and the whole assembly. Thus make ensure all the components are fasten properly.
- Never operate the device with the stirrer tools rotating freely. Ensure that parts of the body, hair, jewellery or items of clothing cannot be trapped by the

rotating parts.

- The safety of the user cannot be guaranteed if the device:
 - ☞ operated with accessories that are not supplied or recommended by the manufacturer.
 - ☞ operated improperly or contrary to the manufacture's specifications.
 - ☞ If the printed circuit board are modified by third parties.
- Do not place any solid particles during motion of the impeller. Use sufficient large container, beaker or flask to avoid spillage.
- Place the device on a flat, stable, clean, non-slippery and fire-proof surface.
- The base plate must be clean and intact.
- Do not try to mix liquid more then recommended volume of liquid (H₂O at room temperature).
- Wear protective equipment in accordance with the hazardous category of the media to be processed. Otherwise, there is a risk from:
 - ☞ Splashing and evaporation of liquids.
 - ☞ Ejection of parts.
 - ☞ Release of toxic or combustible gases.
- Do not lift or hold the device from the power cable.
- Do not use a damaged beaker, flask, chuck/collet or any other component for operation. It may affect the efficiency of the device.
- Reduce the speed:
 - ☞ If the medium splashes out of the vessel
 - ☞ If the appliance is not running smoothly.
 - ☞ If the container moves on the base plate.
- Do not touch the impeller, rotating shaft, stirring liquid extra
- Process pathogenic materials only in a closed vessel under a suitable extractor hood. Do not operate the appliance in explosive atmospheres, with hazardous substances or under water.
- Only use liquid for mixing that will not react dangerously to the extra energy produced through processing. This also applies to any extra energy produced in other ways. Examples included: through light irradiation, through surrounding temperature etc.
- Abrasion of the dispersion equipment or the rotating accessories can get into the medium you are working on.
- The equipment will not restart, both in case of power interruption and in the

case of any fault or mechanical interruption.

- Care should be taken based on the sample used for mixing.

8. MAINTENANCE & CLEANING

- Plug off the Machine while cleaning
- Do not spray cleanser into the instrument when cleaning
- Wear protective gloves while cleaning the machine
- Cleaning should be done with Mild detergent and water
- Wipe the exterior of machine with a Damp cloth
- Always clean the impeller after every use for better operation.

9. INSTALLATION & OPERATION

Open the box, then remove the packaging and gently place the device on a firm and leveled surface. Gently unpack every individual components (machine, power adaptor, impeller, stand, boss head). Assemble each of the components as instructed below for better performance. The user manual should be kept near the device. Please keep all packaging in safe storage for at least 2 (two) years for warranty purpose.

Assembly

Ensure that the extension arm is fitted securely. Vibration may cause the screw to become loose. It is therefore necessary for safe use to regularly check that the extension arm is attached securely. Tighten the hexangular bolt as required.

Check that the stirrer is held in position firmly prior to each use and also at regular intervals. The position of the stirrer must only be adjusted when the equipment is stationary and the power supply is disconnected.

Standard Part Listing

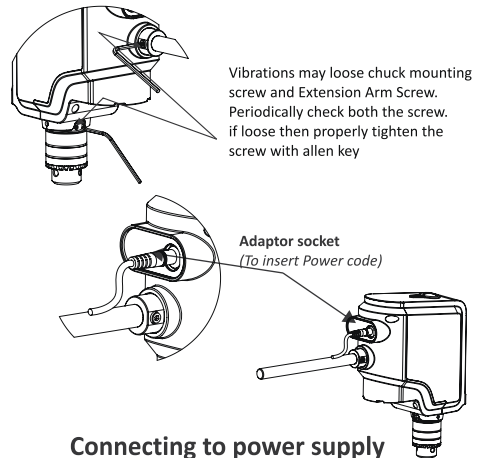
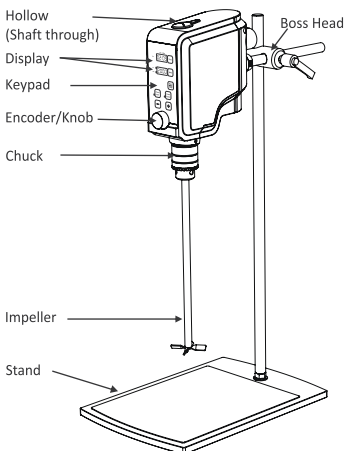

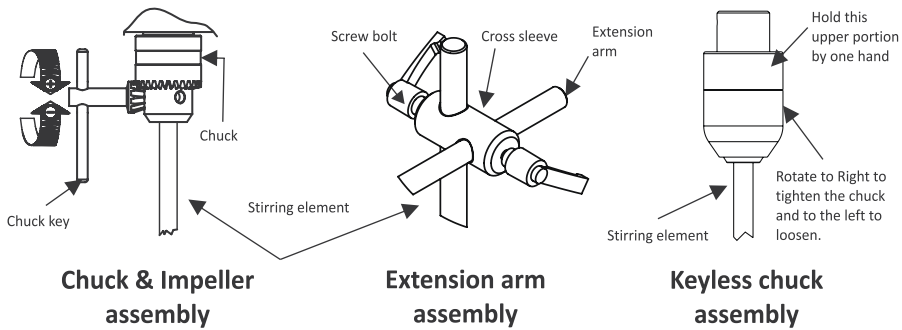

Installation of Impeller

Remove the Cap & rotate to the side before you push through the Impeller.

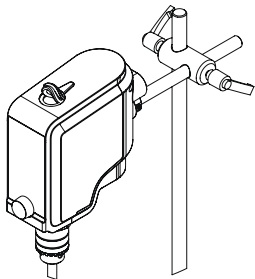





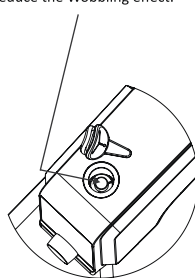
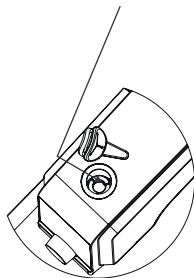

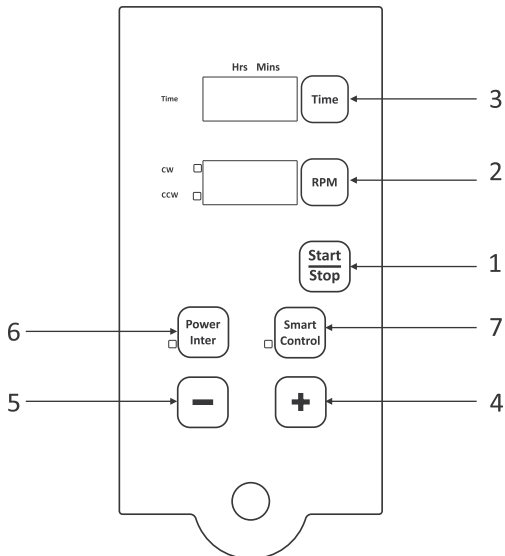

Impeller Balancer

Guide the Impeller into balancer to reduce the Wobbling effect.



USER INTERFACE & DISPLAY



Item	Button Name	Function
1		Press the key to start the mixing & To stop the operation press the same key again.
2		To set speed in RPM, press this key & the desired RPM can set upon blinking & change the values by using +/- key to set. By default the motion will be CW.
3		Press timer key, to set the value between 1min - 99hrs 59mins or continuous mode.
4		Press once to have an increments of 1. Press and hold to increase the value faster.
5		Press once to have a decrements by 1. Press and hold to decrease the value faster.
6		This mode enables user to set auto resume operations from the left time upon re-storage of power if there is any failure, rather than reset of the parameters & restart all the operation from the beginning.
7		This mode enable stirring of the sample even upon change viscosity of the liquid.

Function(All the keys will be operational only upon turning the power switch)

Start / Stop:

Press the key to start the mixing. To stop the operation press the same key again.

RPM:

To set speed in rpm, press the key & the CW/CCW mode will be indicated by the LED. To change the CW/CCW direction press the RPM key again and upon blinking desired rpm can be set in chosen direction. Change the value by using +/- key or Knob.

Timer:

Press time key, to set the value between 1min - 99hrs 59mins & variable time can be set using +/- key. And for infinity/continuous operation mode press and hold the timer button until it shows "[∞]" on the screen.

Increment:

To increase the value, press once to have an increments of 1. Press and hold to increase the value faster. This key is used for adding the values in the parameters such as Speed & timer.

Decrement:

To decrease the value, press once to have a decrements by 1. Press and hold to decrease the value faster. This key is used for reducing the values in the parameters such as Speed & timer.

Power Intermittent Mode:

This mode enables user to set auto resume operations from the left time upon re-storage of power if there is any failure, rather than reset of the parameters & restart all the operation from the beginning.

By Default this mode is off. Press Once to Activate the Mode, will be indicated by LED. Once the mode is turned on, at power failure the machine will remember the last running value save after completing the next 5mins. and the device will resume the operation for the left time only upon the power is restored.

Example: If 60 minute is the set time and the power off happens at 54 or 51minutes, the machine will resume from 55minutes; and if power off happens at 58minutes then it resumes at 60min.

Smart Control:

- **Smart Control OFF:** By default standard over load protection control is active in the device. The actual speed of stirrer shaft will be reduced to zero and device will stop with an Error OL if the device detects the overload in torque then recommended (Refer to specification table & error codes at the end).
- **Smart Control ON:** Switch on the device and press the smart control button, if the torque value is higher than recommended, the device automatically detects & reduces the motor speed until it find optimum speed for constant mixing even at higher torque. Eg: the set rpm say 1000 is higher than the speed will be reduced until it find optimum speed. This speed reduction will take place until the safe speed reached at which the torque value is normal. If it is 750rpm then the device with set 750rpm as new speed & continues to stir. This also will avoid any overload on the machine.

Knob/Encoder:

Turn the knob CW for increment & CCW for decrement of time & speed parameters

10. TROUBLESHOOTING

ERROR	PROBLEM	SOLUTION
No display	No main power connection.	Power check & proper plug-in of main cable at both ends.
	Power failure	Check the mains fuse of the lab.
	Improper connection.	Connect adaptor properly.
OL (Overload)	Require torque to mix the medium at given speed is more then the rated value of the device.	Switch of the device completely. Unplug the power adaptor. This will reset the error. Decrease the load on the motor and restart device again
OT (Over Temperature)	Motor temperature is too high	Switch of the device & allow it cool down
Er 52	No motor feedback	Contact service center or supplier
—	Product vibrates too much & excessive noise durring operation	Check the impeller, bend or damaged impeller may cause vibrations
		Motor might be causing noise due to damage impeller.
		Make adjustments to correct the conditions causing the excessive vibration
		Set wrong parameter like speed & higher viscosity for the selected impeller
—	System stop working	Electronic error, Switch off the product & then switch it ON again. If error still shows contact service representative.

11. WARRANTY STATEMENT

This product is warranted to be free from defects in material and workmanship for a period of two (2) years from the date of purchase. Your product will be duly repaired upon prompt notification in compliance with the following conditions :

This warranty is valid only if the product is used for its intended purpose and within the guidelines specified in this instruction manual. This warranty does not cover damage caused by accident, neglect, misuse, improper service, natural forces or other causes not arising from defects in original material or workmanship. This warranty does not cover any incidental or consequential damages, commercial loss or any other damages from the use of this product.

The warranty is invalidated by any non-factory modification, which will immediately terminate all liabilities on us for the products or damages caused by its use. The customer shall be responsible for the product or use of products as

well as any supervision required for safety. If requested the products must be returned to the distributor in well packed and insured manner and all shipping charges must be paid.

Note: *Some states do not allow limitation on the length of implied warranties or the exclusion or limitation of incidental or consequential damages. This warranty gives you specific legal rights. This warranty is given expressly in lieu of all other warranties, expressed or implied.*

The purchaser agrees that there is no warranty of merchantability or of fitness for any intended purpose and there are no other remedies or warranties, implied, which extend beyond the description on the face of the agreement. This warranty is only applicable to the original purchaser.

Products received without proper authorization will not be processed for warranty or service. All items returned for service should be sent with postage prepaid in the original packaging or another suitable packaging, padded to avoid damage. We will not be responsible for damage incurred by improper packaging.

Note: *This warranty is valid only if the warranty is registered with the supplier within 30 days from the date of purchase.*

12. PRODUCT DISPOSAL

In case the product is to be disposed of, the relevant legal regulations are to be observed.

Information on the disposal of electrical and electronic devices in the European Community.

The disposal of electrical devices is regulated within the European Community by national regulations based on EU Directive 2012/19/EU on waste electrical and electronics equipment (WEEE). According to these regulations, any devices supplied after 13.06.05 in the business to a business sphere, to which this product is assigned, may no longer be disposed of in municipal or domestic waste. They are marked with the following symbol to indicate this.



As disposal regulations within the EU may vary from country to country please contact your supplier if necessary.

















For your reference, make a note of the serial number, date of purchase and supplier here.

Serial No.

Purchase Date

Supplier

13. IMPELLER TECHNICAL SPECIFICATION

Images	Cat. No.	Type	Flow	Blade size (mm)	Ø (mm)	Length (mm)	Shaft dia (mm)	Max. rpm	Viscosity Range mPas	Application	OH 8 Prime	OH 15 Prime	OH 20 Prime	OH 40 Prime
	A01	Propeller Blade Impeller	Axial	50x8	50	550	10	2000	0-10,000	For High Speed & Low Viscosity mixing	2000	1000	2000	1000
	A02	Propeller Blade Impeller	Axial	100x15	100	550	10	800	0-20,000	For Low to Medium Speed & Low to High Viscosity mixing	600	600	600	600
	A03	Propeller Blade Impeller	Axial	130x15	130	800	10	600	0-30,000	For Low to Medium Speed & Low to medium Viscosity mixing	400	400	400	400
	R01	Cross-welded Impeller	Radial	50x12	50	550	10	2000	0-10,000	For High Speed & Low Viscosity mixing	1800	1000	1800	1000
	R02	Straight Blade Impeller	Radial	35x12	35	550	10	2000	0-10,000	For High Speed & Low Viscosity mixing	2000	1000	2000	1000
	R03	Straight Blade Impeller	Radial	50x12	50	550	10	2000	0-10,000	For High Speed & Low Viscosity mixing	1800	1000	1800	1000
	R05	Flooding Blade Impeller	Radial	60x15	60	550	10	1800	0-10,000	For High Speed & Low Viscosity mixing	1700	1000	1700	1000
	R07	Colapostole Blade Impeller	Radial	80x10	80	550	10	1500	0-10,000	For High Speed & Low Viscosity mixing	800	800	800	800
	T02	Square Blade Impeller	Tangential	38x38	38	550	10	1000	0-30,000	For Low to Medium Speed & Low to Medium Viscosity mixing	800	800	1000	1000
	T03	Square Blade Impeller	Tangential	70x70	70	800	10	600	0-50,000	For Low to Medium Speed & Low to Medium Viscosity mixing	400	400	400	400
	T05	Anchor Blade Impeller	Tangential	45x45	45	550	10	800	0-100,000	For Low to Medium Speed & High Viscosity mixing	500	500	800	800
	T06	Anchor Blade Impeller	Tangential	90x80	90	800	10	600	0-100,000	For Low to Medium Speed & High Viscosity mixing	300	300	300	300
	T08	Paddle Blade Impeller	Tangential	70x70	70	550	10	800	0-100,000	For Low to Medium Speed & High Viscosity mixing	500	500	500	500
	T09	Paddle Blade Impeller	Tangential	70x70	70	800	10	600	0-100,000	For Low to Medium Speed & High Viscosity mixing	400	400	400	400
	T10	Paddle Blade Impeller	Tangential	70x80	70	550	10	800	0-100,000	For Low to Medium Speed & High Viscosity mixing	500	500	500	500
	T11	Paddle Blade Impeller	Tangential	70x80	70	800	10	600	0-100,000	For Low to Medium Speed & High Viscosity mixing	400	400	400	400

Accumax Lab Devices Private Limited

Plot No. 15, 16 & 32 GIDC Electronic Park SEZ, Sector 26, Gandhinagar, Gujarat, India - 382026.

Website: www.neuation.com