

# NEUATION

TECHNOLOGIES



## iSTIR HP5M/10M/15M

PRODUCT USER MANUAL

# CONTENTS

1. Product Description	1
2. Intended Use	1
3. Features	1
4. Technical Specifications	1
5. Accessories	2
6. Safety Instructions	2
7. Installation	3
8. Standard Parts Listing	4
9. User Interface & Display	5
10. Tips for Efficient Operation	5
11. Operation	6
12. Trouble Shooting	8
13. Warranty Statement	9
14. Product Disposal	10

## 1. PRODUCT DESCRIPTION

This manual provides important safety information for this Multistation Hot Plate Stirrer. It should be kept near the equipment for quick & easy reference. This stirrer is specially designed for precise control of stirring speed and temperature which allows gentle to vigorous mixing with speed ranging from 300 to 1500 RPM. This heated version can be used as a combination of heater and stirrer OR as only Stirrer OR only Heater with temperature range from ambient to 120° C. This unit also comes with a programmable pulse mode for better mixing. The space saving Stirrer is designed with utmost safety and this stirrer is a concealed design meeting IP 42 protection.

## 2. INTENDED USE

This stirrer is designed for use in chemical and pharmaceutical industry for mixing and/or heating liquids.

**NOTE:** Before using the instrument, please read this user manual carefully. This user manual is intended to assist with the operation and care of the unit only and not its repair. For repair please contact the supplier.

## 3. FEATURES

- High-Performance multi-position stirrer with 5/10/15 stirring positions with the optimum use of laboratory space.
- Variable speed and time setting with digital display.
- Temperature setting from ambient to 120°C.
- Homogeneous temperature distribution across heating plate using multiple sensors.
- Brushless DC motor for long life and maintenance free operation.
- Simultaneous display of actual and set temperature through the digital display.
- Noiseless and consistent stirring at all 10 positions.
- Dedicated LED for “HOTPLATE” indication.
- Pulse mode for vigorous mixing.
- Waterproof heater with inbuilt safety cutoff.

## 4. TECHNICAL SPECIFICATIONS

Product	HP 5M	HP 10M	HP 15M
Motor Type	BLDC		
Number of Stirring positions	5	10	15
Max Stirring quantity per position	400 ml		
Max Stirring Quantity on Equip (H <sub>2</sub> O)	2 Liters	4 Liters	6 Liters
Speed range	300 to 1500 RPM		
Speed control	10 RPM / Step		

## 4. TECHNICAL SPECIFICATIONS

Heater Temp. range	Room Temp. to 120°C		
Max temperature in medium	70°C (depending upon vessel)		
Temperature control	1°C / Step		
Time range	1 to 999 minutes & Infinite		
Recommended Stirring bar length	25 mm		
Set-up plate dimensions	456 x 118 mm	460 x 178 mm	460 x 264 mm
Dimensions (W x D x H)	565 x 136 x 75 mm	565 x 196 x 75 mm	568 x 282 x 76 mm
Heat output	330 W (110V)	330 W (110V)	682 W (110V)
	375 W (220V)	375 W (220V)	750 W (220V)
Protection class according to DIN EN	IP 42		
Permissible ambient temp.	5 - 40°C		
Permissible relative humidity	80%		
Weight	3 Kg	5 Kg	7 Kg
Input Voltage	110V --- 3.6A	110V --- 3.6A	110V --- 7.25A
	220V --- 1.7A	220V --- 1.7A	220V --- 3.45A
Power Consumption	400 W	400 W	800 W

## 5. ACCESSORIES

Power cord, User manual, Warranty card, Reference stir bar.







## 6. SAFETY INSTRUCTIONS

In order to use this equipment properly & safely every user must read the user manual & observe safety instructions.

- Do not place any steel or magnetic material on the top surface except beaker or flask with the recommended magnetic stirring bar. Doing this can affect the magnetism of device.
- Place the device on a flat, stable, clean, non-slippery and fire-proof surface.
- The top surface must be clean and intact. Use a soft mild cloth to clean.
- Do not try to stir liquid more that 400 ml with 25 mm magnetic stirring bar per stirring position. It may lead to improper mixing.
- Wear your personal protective equipment in accordance with the hazardous category of the media to be processed. Otherwise, there is a risk from:
  - ☞ Splashing and evaporation of liquids.
  - ☞ Ejection of parts.
  - ☞ The release of toxic or combustible gases.
- Properly lift the device with both hands from the base while shifting or installing

## 6. SAFETY INSTRUCTIONS

at other location.

7. Do not use damaged beaker, flask, stirring bar or any other component for operation. It may affect the efficiency of device.
8. Reduce the speed:
  -  If the medium splashes out of the vessel because to high speed.
  -  If the appliance is not running smoothly.
  -  If the container moves on the base plate.
9. Wear protective gloves while cleaning the device.
10. The top surface will be hot after any heating operation. Do not touch the top surface till the hot LED indication glows. 
11. Process pathogenic materials only in a closed vessel under a suitable extractor hood. Do not operate the appliance in explosive atmospheres, with the hazardous substance or under water.
12. Only use such liquids for mixing which will not react dangerously to the extra energy produced through heating & stirring. This also applies to any extra energy produced through external sources. For example: Through light irradiation, through surrounding temperature etc. 
13. Abrasion of the dispersion equipment or the rotating accessories can get into the medium you are working on.
14. The chemical reaction of PTFE can occur when in contact with molten or dissolved alkaline earth metals, as well as with fine partied powders of metals of the 2 and 3 group of the periodical system at temperatures above 300-400 °C. Only elementary fluorine, chlorine trifluoride and alkaline metals do attack PTFE, halogen hydrocarbons have a reversible swelling effect.
15. In case of power failure or mechanical interruption, stirrer will not start automatically after the restoration of power or mechanical parts. Due care should be taken.
16. Process and heat only that media which has a flash point up to 150°C. 

## 7. INSTALLATION

The multi-position stirrer is provided in a stiffly packed box. Open the box, remove the packaging and gently place the device on the firm & leveled surface. Take care while unpacking & and gently remove all accessories. The user manual should be kept with the device for easy access. Please keep all packaging in safe storage for at least two years for warranty purpose.

### 7.1 LOCATION & MOUNTING

Place the stirrer on a flat and leveled surface; ensure that the four feet of this stirrer stands on the surface firmly. Avoid installing on a slippery surface or surface prone to vibration.

## 7. INSTALLATION

1. Ideal ambient temperature is  $20^{\circ}\text{C} \pm 5^{\circ}\text{C}$ ; avoid placing the unit in direct sunlight.
2. Keep clearance of at least 20 cm from all side to guarantee the cooling efficiency.
3. Keep away from heat or water to avoid sample temperature issues.
4. Do not place the stirrer in a place where it becomes difficult to operate the device.

### 7.2 CONNECTING POWER CORD

1. Connect one end of the power cord to the rear side of stirrer and another end to supply socket as shown in the figure below.
2. Push the power cord firmly for proper connection.

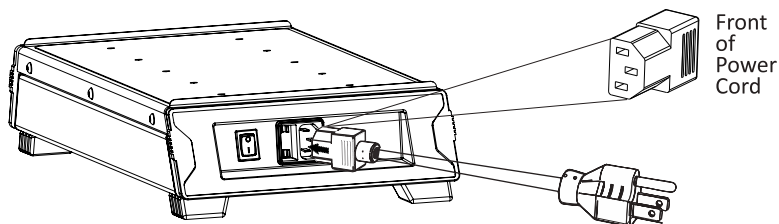

## 8. STANDARD PARTS LISTING

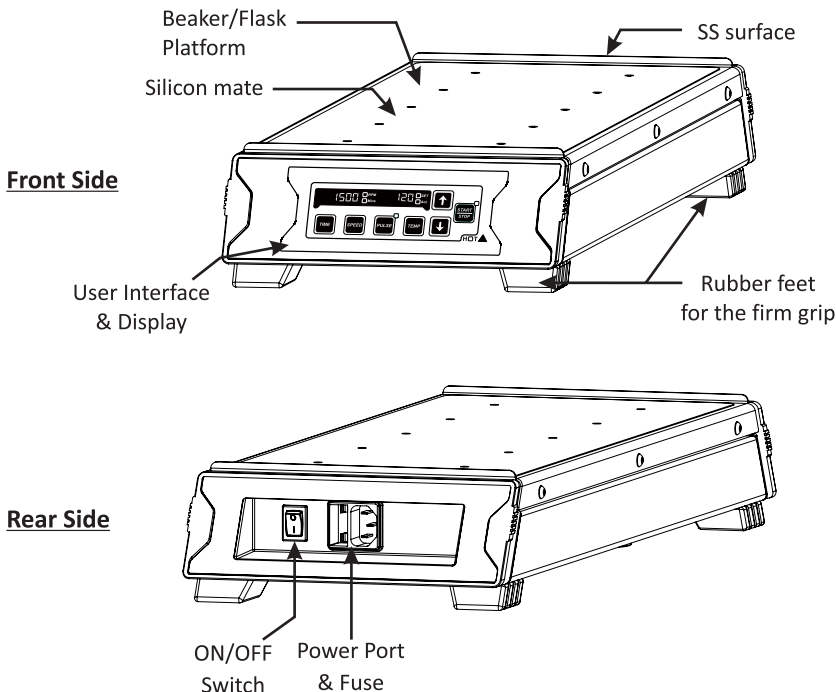

## 9. USER INTERFACE AND DISPLAY

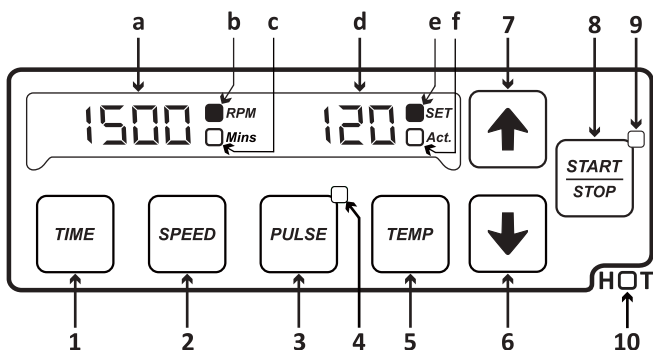

Display			
a) 1500	b) <input type="checkbox"/> RPM c) <input type="checkbox"/> Mins	d) 120	e) <input type="checkbox"/> SET f) <input type="checkbox"/> Act.
Display shows current <b>speed &amp; time</b> values	LEDs indicates which parameter is selected - Speed or time	Display shows Set or Actual <b>Temperature value in °C</b>	LEDs indicates which temp. value is displayed - SET or ACTUAL

User Interface	
<b>1) Time</b>	: Press "Time " to select time value. Then press "+/-" to set Time value in minutes.
<b>2) Speed</b>	: Press "Speed " to select Speed value. Then press "+/-" to set Speed value in RPM.
<b>3) Pulse</b>	: Press "Pulse " to start pulse mode operation.
<b>4) Pulse LED</b>	Pulse LED glow to indicate Pulse mode activation.
<b>5) Temp</b>	: Press "Temp " to select Temperature value. Then press "+/-" to set Temp value in °C.
<b>6) Increment</b>	: Press "+/-" " to increase values.
<b>7) Decrement</b>	: Press "'+/-'" " to decrease values
<b>8) Start/Stop</b>	: Press "Start/Stop " to start and stop operation.
<b>9) Start/Stop LED:</b>	Glowing LED indicates Start of Operation. Off LED indicates Stop of Operation.
<b>10) HOT LED</b>	: Glow when platform of the stirrer is HOT above 50°C

## 10. TIPS FOR EFFICIENT OPERATION

Use flat, chemical resistant and heat-resistant vessels made up of glass. The vessels should have a thin, even wall thickness. Flat glass bottoms (without any curve on

## 10. TIPS FOR EFFICIENT OPERATION

the inside) and smooth surfaces will improve the efficiency of the magnetic stirring bar. Uneven surfaces would reduce the stirring power and would reduce the efficiency of stirring.

Place one magnetic stir bar in each stirring flask. Place the flasks with stir bar right in the center of the stirring point on the respective bore of the Stirring platform. This will ensure the optimum stirring effect!

In case the magnetic stir bar is not at the center or sets away from the center during the operation, check the flasks/beaker positions and move the flasks/beakers slightly to & fro around the center and place the flasks/beakers on the platform surface such that the magnetic stir bar resumes its normal stirring motion.

If the above-mentioned procedure doesn't work, reduce the speed or amount of sample liquid in the flasks/beakers in case the bar does not stir.

## 11. OPERATION

### 11.1 Switch on the Stirrer

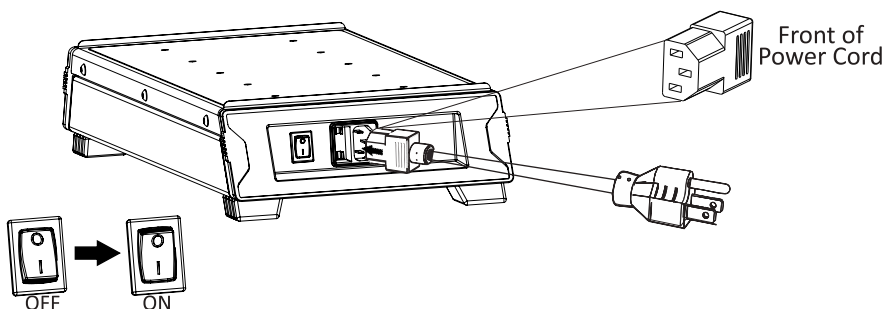

After connecting the power cord, switch ON the mains and switch ON the stirrer from rear side as shown in above image.

### 11.2 Setting Time & Speed

The time in the display is in minutes. The stirrer timer set for operation is in between 1min to 999mins and infinite time mode. Infinite time is seen as " ][" . Press "Time" to select time value and press "+ / - " to set time. When time button is pressed, the "Mins" display will blink indicating the time value is selected. Once time value is selected, single press "+/-" will increase or decrease time value by 1min.

Long press increment or decrement button to quickly increase or decrease time value. Time value gets saved after 5 blinks. The timer is a countdown timer showing remaining time left. Once time is over, the stirrer stops. Speed is displayed as RPM.



## 11. OPERATION

The minimum and maximum speed of stirrer is 300 RPM and 1500 RPM respectively. When the equipment is used for the 1st time, the speed will be set to zero and shown as “0000”. Once speed value is selected, single press “+/-” will increase or decrease speed value by 10 RPM. Long press “+/-” to quickly increase or decrease speed value. Speed value gets saved after 5 blinks.

### 11.3 Setting Temperature

Initially, on every startup, the temperature function will be in OFF state. To set Temperature, Single press “Temp” button to select Temperature value and then press “+/-” to set temperature value. Once the temperature is set, display will glow indicating the SET Temperature.

Temperature value can be set from Ambient temperature to 120°C. Once Temperature value is selected, pressing “+/-” will increase or decrease temperature value by 1°C. Long press “+/-” to quickly increase or decrease the temperature value. Temperature value gets saved after 5 blinks.

To see the actual temperature value, again single press the Temp button and the ACT. LED will glow indicating the value displayed is current Actual Temperature. By default, the actual temperature value will be room temperature.

**NOTE:** 1) Process and heat only those media that has a flash point up to 150°C.

2) Be extra cautious when touching the heating stirrer platform. The heating stirrer platform can reach up to 125°C.

### 11.4 Pulse Mode Operation

Press “Pulse” to start pulse mode operation. In pulse mode, the stirring direction will change between clockwise and counter-clockwise direction for every 30 seconds which can be set from 30 to 99 seconds. Upon the selection of “PULSE”, pulse button will glow. Again press the “Pulse” button to STOP pulse operation.

### 11.5 Programmable Pulse Mode Operation

By default, the pulse mode cycle time is 30 seconds (i.e. 30 seconds clockwise and 30 seconds anti-clockwise). With programmable pulse mode, the user can modify cycle time from 30 secs to 99 secs. Long press the pulse button to select pulse mode cycle time. The time display will change to “s 30” where “30” means pulse cycle time in seconds - this indicates that user can now modify pulse cycle time. Then press increment or decrement button to modify cycle time between 30 secs to 99 secs.

### 11.6 Start & Stop Operation

Once all the parameters like Speed, Time & Temperature are set, press “Start/Stop” button once to START operation. Once operation starts, the LED adjacent to “Start/Stop” will glow.

## 11. OPERATION

To STOP operation, again press the “Start/Stop” button. LED adjacent to the button will stop glowing indicating that the operation is stopped.

Make sure that stirring operation is started only after flask/beaker is placed on the surface. Placing the beaker/flask in between any operation can lead to improper stirring or no stirring at all.

*NOTE: Proper stirring is achieved only if beaker/flask is placed before any run operation or only if speed is increased gradually for stirring.*

### 10.7 HOT indication



**Do not touch the top surface if the HOT LED is Glowing. HOT LED gives an indication that the temperature of the top surface is above 50°C.**

## 12. TROUBLE SHOOTING

**Any type of malfunction during operation can be identified by the error message on display. Proceed as follows in such cases.**

### 1. Problem : No Display.

- Solution :
- 1) Check main power is available.
  - 2) Check that power adaptor is working properly and it is properly connected at both ends.
  - 3) If the problem still persists then call authorized service person.

### 2. Problem : Err 1.

**Root Cause : Motor Struck.**

- Solution :
- 1) First switch off the equipment, plug out the power adaptor and plug it in again.
  - 2) If the problem still persists then call authorized service person.

### 3. Problem : Err 3.

**Root Cause : If the temperature of heating plate is higher than set value of temperature.**

- Solution :
- 1) Switch off & let it cool down then Restart the device.
  - 2) If the problem still persists then call authorized service person.

### 4. Problem : Err 4.

**Root Cause : Failure of safety circuit.**

- Solution :
- 1) Switch off & let it cool down then Restart the device.
  - 2) If the problem still persists then call authorized service person.

### 5. Problem : Err 6.

**Root Cause : Internal Temperature of device exceeds 80°C.**

- Solution :
- 1) Switch off & let it cool down then Restart the device.
  - 2) Change the parameters and observe the max ambient temperature.
  - 3) If the problem still persists then call authorized service.

## 12. TROUBLE SHOOTING

### 6. Problem : Err 7.

**Root Cause : Thermocouple not connected / damage.**

Solution : 1) Switch off the device and allow it to cool down then Switch On.  
2) If the problem still persists then call authorized service person.

### 7. Problem : Err 8.

**Root Cause : Thermocouple response poor.**

Solution : 1) Switch Off the device and call authorized service person.

## 13. WARRANTY STATEMENT

This product is warranted to be free from defects in material and workmanship for a period of two (2) years from the date of purchase. Your product will be duly repaired upon prompt notification in compliance with the following conditions:

This warranty is valid only if the product is used for its intended purpose and within the guidelines specified in this instruction manual. This warranty does not cover damage caused by accident, neglect, misuse, improper service, natural forces or other causes not arising from defects in original material or workmanship. This warranty does not cover any incidental or consequential damages, commercial loss or any other damages from the use of this product.

The warranty is invalidated by any non-factory modification, which will immediately terminate all liabilities on us for the products or damages caused by its use. The buyer and its customer shall be responsible for the product or use of products as well as any supervision required for safety. If requested the products must be returned to the distributor in well packed and insured manner and all shipping charges must be paid.

Some states do not allow limitation on the length of implied warranties or the exclusion or limitation of incidental or consequential damages. This warranty gives you specific legal rights. This warranty is given expressly in lieu of all other warranties, expressed or implied.

The purchaser agrees that there is no warranty of merchantability or of fitness for any intended purpose and that there are no other remedies or warranties, expressed or implied, which extend beyond the description on the face of the agreement. This warranty is only applicable to the original purchaser.

Products received without proper authorization will not be entertained. All items returned for service should be sent postage prepaid in the original packaging or other suitable carton, padded to avoid damage. We will not be responsible for damage incurred by improper packaging.

This warranty is valid only if the warranty is registered with the supplier within 30 days

### 13. WARRANTY STATEMENT

from the date of purchase.

For you reference, make a note of serial number, date of purchase and supplier here.	
Serial No.:	Purchase Date:
Supplier:	

### 14. PRODUCT DISPOSAL



In case the product is to be disposed of, the relevant legal regulations are to be observed.

Information on the disposal of electrical and electronics devices in the European Community.

The disposal of electrical devices is regulated within the European Community by national regulations based on EU Directive 2012/19/EU on waste electrical and electronics equipment (WEEE). According to these regulations, any devices supplied after 13.06.05 in the business to the business sphere, to which this product is assigned, may no longer be disposed of in municipal or domestic waste. They are marked with the following symbol to indicate this.

As disposal regulations within the EU may vary from country to country please contact your supplier if necessary.

## **Neuation Technologies Pvt. Ltd.**

Plot No. 15, GIDC Electronic Park SEZ Kolavada Road, Gandhinagar – 382026, Gujarat, India

---

**Website:** [www.neuation.com](http://www.neuation.com)