

centrifuge - Cat. No.: 10223c  
user manual - Cat. No.: 20223c/ENG



2012-06-25

# USER MANUAL



## LABORATORY CENTRIFUGE

# MPW-223c



**Read this before use!**

MPW MED. INSTRUMENTS 46 Boremlowska Street, 04-347 Warsaw/Poland  
tel. +48 22 610 81 07 (service), fax +48 22 610 55 36  
mpw@mpw.pl, www.mpw.pl





**Warning signs and hazard icons.**

---



**WARNING**

Warning of potential injury or health risk.

---



**DANGER**

Risk of electric shock with potential for severe injury or death as a consequence.

---



**DANGER**

Biohazard with potential for risk to health or death as a consequence.

---



**DANGER**

Risk of explosion with potential for severe injury or death as a consequence.

---

***Statement of Conformity:***

The following machine is in accordance with the regulations of the EU Directive 98/79/EC and with the harmonized standards PN-EN 61010-1 and PN-EN 61010-2-020.

# Contents

## **1. Application.**

## **2. Technical data.**

- 2.1. Accessories.
  - 2.1.1. Basic accessories.
  - 2.1.2. Special accessories - „Cytoset”
  - 2.1.3. Optional accessories
- 2.2. Exploitation materials.

## **3. Installation.**

- 3.1. Unpacking of the centrifuge.
- 3.2. Location.
- 3.3. Connection to mains.
- 3.4. Fuses.

## **4. Description of the centrifuge.**

- 4.1. General description.

## **5. Safe working conditions.**

- 5.1. Operating personnel.
- 5.2. Guarantee period and operation life.
- 5.3. Storage period.
- 5.4. Hints on centrifuging.
- 5.5. Hazards and precautions.

## **6. Operation of the centrifuge.**

- 6.1. Mounting of the rotor and accessories.
- 6.2. Construction and safety measures.
- 6.3. Drive.
- 6.4. Data input and output.
- 6.5. Controls.
- 6.6. Safety devices.
  - 6.6.1. Cover lock.
  - 6.6.2. Rest state check.

## **7. Description of the centrifuge operating elements.**

- 7.1. Control panel
- 7.2. Switching the centrifuge on
  - 7.2.1. Selection of the program.
  - 7.2.2. Start of the program.
  - 7.2.3. Emergency stop.
  - 7.2.4. End of the centrifuging.
  - 7.2.5. Programming.
- 7.3. Mathematical relations.
  - 7.3.1. RCF – relative centrifugal force, nomograph.

## **8. Cytology kit cytoset.**

- 8.1. Intended Use.
- 8.2. Benefits of "Cytoset".
- 8.3. Work parameters.
- 8.4. Kit contents.
- 8.5 Working principle.
- 8.6. Preparation of samples for centrifugation.
- 8.7. Table of dilutions in hematology
- 8.8. Preparation of the cyto-container with the passing of the filtrate through blotting paper.
- 8.9. Preparation of the cyto-container with filtrate retrieval
- 8.10. Centrifugation parameters
- 8.11. Steps in the use of centrifuge with the "CYTOSET" kit
- 8.12 Procedure after centrifugation, when the filtrate is lost
- 8.13. Procedure following centrifugation, with the filtrate retrieved
- 8.14. General View of Cytology kit – Cytoset.

## **9. Cleaning, disinfection, maintenance.**

- 9.1. Cleaning of the centrifuge.
- 9.2. Cleaning of the accessories.
- 9.3. Sterilization and disinfection of the rotating chamber and accessories.

## **10. Emergency conditions – service.**

- 10.1. Troubleshooting.

## **11. Work safety.**

- 11.1. Work safety inspection procedures.
- 11.2. Inspection procedures carried out by the operator.

## **12. Conditions of repairs.**

## **13. Manufacturer's data.**

## **14. Information about Distributor.**

## **15. Table of chemical resistance to the interaction of various categories of reagents of plastics**

### **Annexes:**

- **Statement of conformity**
- **Declaration of decontamination (repair)**
- **Declaration of decontamination (return)**

## 1. Application.

The MPW-223c centrifuge is a table top laboratory centrifuge intended for *in vitro* diagnostic (IVD). Its construction ensures easy operation and safe work. It is intended for “CYTOSET” kit. Its intended use is the centrifugal separation of body fluids into fine subconstituent elements from the filtrate. This centrifuge is not biotight.

## 2. Technical data.

### *Manufacturer:*

**“MPW MED. INSTRUMENTS”  
SPÓŁDZIELNIA PRACY  
46 Boremlowska Street, Warsaw/Poland**

### *Type:*

### **MPW-223c**

Mains L1+N+PE V/Hz  $\pm 10\%$

230 V 50/60 Hz, optionally 110 V 50/60 Hz

Maximum power consumption

55 W

Electric shock protection level

basic

Interference level

PN-EN-55011

Noise level

50 dB

Rotational speed range

300 ÷ 2500 rpm

Maximum acceleration RCF

750 x g

Maximum kinetic energy

500 Nm

Maximum capacity

8 ml

Time range

1 ÷ 99 min

SHORT – short duration operation

### *Physical data:*

Depth

435 mm

Width

355 mm

Height

270 mm

Weight

10,5 kg

### *Centrifuge operation conditions:*

PN-EN-61010-1 p.1.4.1.

Environmental temperature

+2° ÷ +40° C

Relative humidity at ambient temperature

< 80 %

Installation category

II PN-EN 61010-1

Degree of pollution

2 PN-EN 61010-1

Protection zone

300 mm

## 2.1. Accessories.

### 2.1.1. Basic accessories (enclosed with every centrifuge).

- 17099T	spanner for the rotor	pcs.	1
- 17142	complete clamp	“	1
- 17162	spanner for the key	“	1
- 17861	fuses WTA T4 A 250 V	“	2
- 17866	power cord 230 V	“	1
- 17867	power cord 110 V (optionally)	“	1
- 20223c/ENG	User manual	“	1

## 2.1.2. Special accessories - „Cytoset”

Cat. No.	Specification		Max rpm	RCF
12271	swing-out rotor	4 buckets	2500	750
13606	Hanger for cyto-container;			
15123	Decantation test tube (2.2 ml) with a cap ( $\phi$ 10,8x43 mm);			
16610	Cyto-container;			
16614	Basic microscope slide;			
16616	Blotting/filtration card $\phi$ 9,5 mm for cyto-container;			
16617	Blotting/filtration card $\phi$ 12,5 mm for cyto-container;			

## 2.1.3. Optional accessories

Cat. No.	Specification		Max rpm	RCF
12218	Swing-out rotor	2x1MTP (microtiter plate)	2500	636
13219	Bucket 85x130 mm for 1 microtiter plate;			
15102	Microtiter plate with cap (85,5x127 mm);			

## 2.2. Exploitation materials.



For operating in centrifuge one should use only original company's buckets comprised in the specification of accessories as well as test-tubes for centrifuges of proper diameter, length and strength. Utilization of test-tubes of other makes shall be agreed upon with manufacturer of the centrifuge. For cleaning and disinfecting one should use agents generally applied in the health service, such as e.g. *Aerodesina-2000*, *Lysoformin 3000*, *Melseptol*, *Melsept SF*, *Sanepidex*, *Cutasept F*.

## 3. Installation.

### 3.1. Unpacking of the centrifuge.

Open the package. Take out the cardboard box containing the accessories. Take out the centrifuge from the package. Keep the package and packing materials at hand for possible transport at a later date.

### 3.2. Location.



The centrifuge shall not be located near the radiators and shall not be subjected to direct sunlight. The table for the centrifuge shall be stable and shall have flat-levelled table top. It is necessary to ensure a safety zone of the minimum 30 cm round the centrifuge from every direction. Normal operating conditions ambient temperature is from 15° C to 35° C. Passed parameters of the centrifuge are referring to the above named temperatures. At the change of the place from cold to warm one, condensation of water will occur inside the centrifuge. It is important then that sufficient time be provided for drying the centrifuge prior to starting the centrifuge again (minimum 4 hours).

### 3.3. Connection to mains.



Supply voltage given on the rating plate has to be consistent with local supply voltage. MPW MED. INSTRUMENTS laboratory centrifuges are in I safety class devices and they are provided with the three-core cable with the plug resistant to dynamic loadings. Mains socket shall be provided with the safety pin. It is recommended to install emergency cut-out that shall be installed far from the centrifuge, near the emergency exit or beyond the room.

Supply voltage 230 V 50/60 Hz, optionally, 115 V 50/60 Hz.



**Before switching on, check whether the centrifuge is connected to power supply correctly. Check centrifuge before using whether it is installed correctly.**

### 3.4. Fuses.

The centrifuge has standard protection with the WTA-T 4A 250V fuse situated in the plug-in socket and master switch unit at back wall of the centrifuge.

## 4. Description of the centrifuge.

### 4.1. General description.

New generation of MPW MED. INSTRUMENTS laboratory centrifuges is provided with modern microprocessor control systems, very durable and quiet asynchronous brushless motors and accessories consistent with modern requirements.

### 4.2 Maintenance elements.

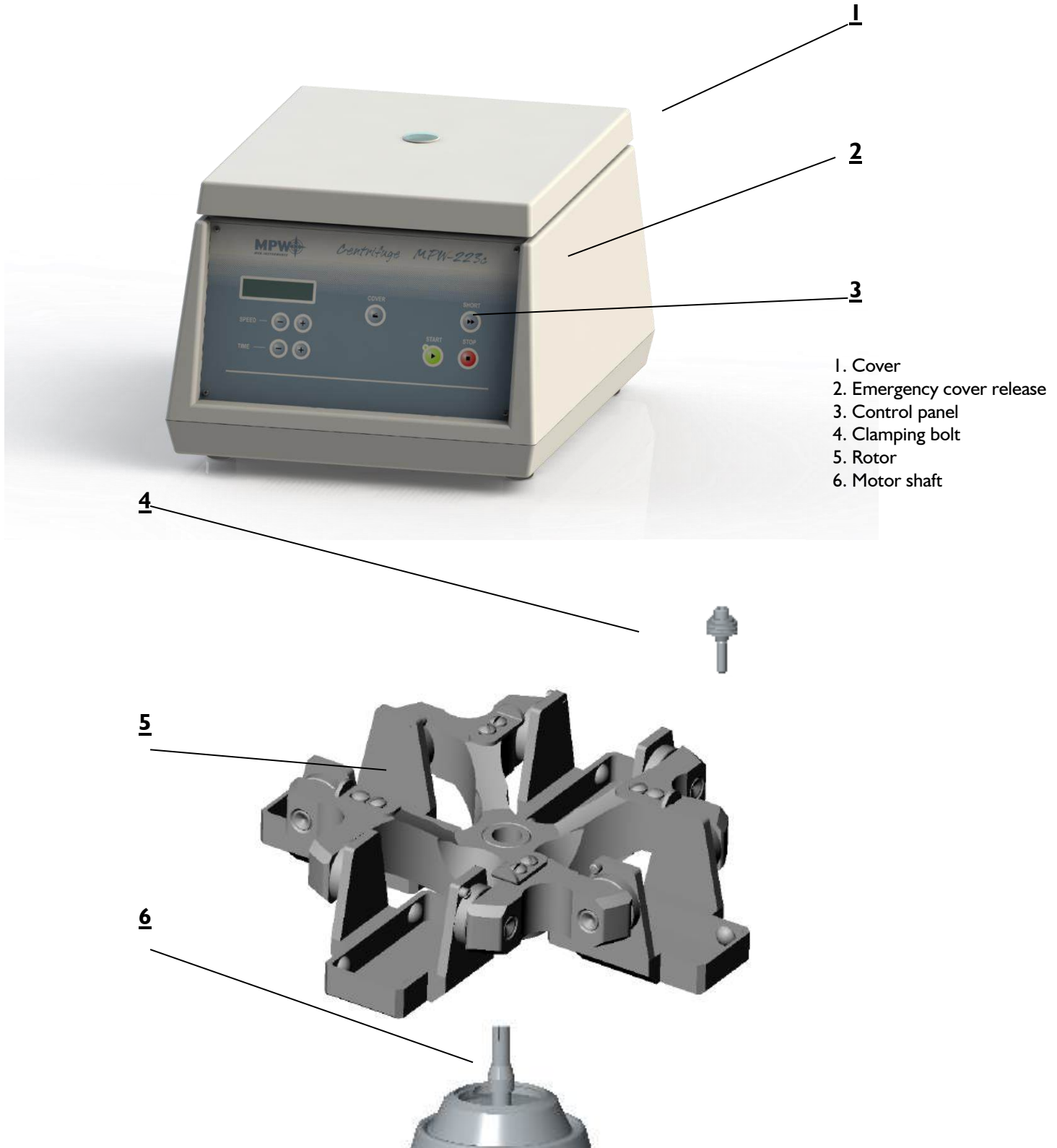



## 5. Safe working conditions.

### 5.1. Operating personnel.

MPW-223c laboratory centrifuge can be operated by laboratory personnel after getting acquainted with the Operating Instruction.



Operating Instruction shall be held all the time near the centrifuge.  
Operating Instruction must be kept close always at hand!!!

### 5.2. Guarantee period and operation life.

Guarantee period for MPW-223c centrifuge amounts to minimum 24 months.

Principles are specified in guarantee certificate. The service life of the centrifuge specified by the manufacturer amounts to 10 years.



*After termination of guarantee period it is necessary to carry out yearly technical inspections of the centrifuge. Only service personnel authorized by manufacturer may perform the inspections.*

The manufacturer reserves the right to make modifications at produced goods.

### 5.3. Storage period.

Maximum period of storage of not used centrifuge amounts to 1 year. After this period one should ask authorized service to carry out an inspection of the device.

### 5.4. Hints on centrifuging.

---



- Set the centrifuge in horizontal position on rigid base.
  - Ensure safe positioning location.
  - Ensure free space around the centrifuge (amounting to at least 30 cm left free).
  - Ensure sufficient ventilation.
  - Fix the rotor on the motor axis firmly.
- 



- Avoid unbalance.
- Load opposite buckets with the same accessories.
- Centrifugation of the test tubes of different sizes.  
There is a possibility to centrifuge test tubes of different sizes; however, it is absolutely necessary in such cases that opposite buckets and round carriers be the same. Mass of different containers with test tubes spun at the same time has to be comparable.

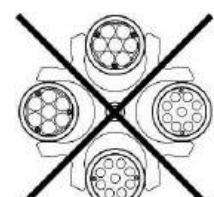
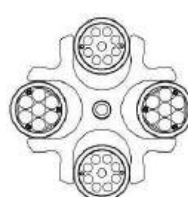
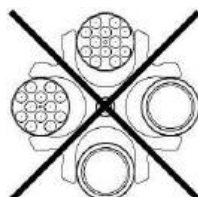
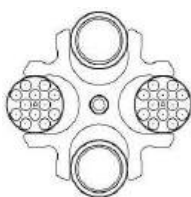

- Not only the test tubes shall be inserted symmetrically, but also round carriers and their hangers shall be equally loaded. It is e.g. not allowed to operate centrifuge only external part of reductive insert loaded.
- It is necessary to insert test tubes symmetrically on the opposite sides.

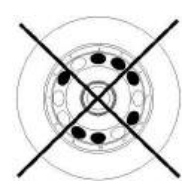
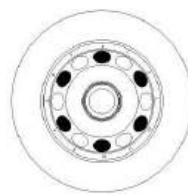

- Fill test tubes outside the centrifuge.
  - Please pay special attention to the quality and proper thickness of the glass test tubes walls. Those shall be test tubes for centrifuges, of proper durability up to 5,000 x g.
  - In order to protect the centrifuge against unbalance, fill in the test tubes up to the same weight.
-



- Lubricate the swing-out rotor journal pins.
  - Use only accessories in good condition.
  - Protect equipment against corrosion using accurate preventive maintenance.
- 



- Infectious materials could be processed in closed buckets only.
- 



- It is not allowed to centrifuge explosive and inflammable materials.
  - It is not allowed to centrifuge substances prone to reacting in result of supplying high energy during centrifugation.
- 

### 5.5. Hazards and precautions.

---



- Prior to switching the centrifuge on, one shall read carefully all sections of this instruction in order to ensure smooth operation and avoid damages of this device or its accessories.
- 

- Centrifuge shall not be operated by unqualified personnel.
- 



- Centrifuge must not be transported with the rotor mounted on the shaft.
- 

- One must use original rotors, test-tubes and spare parts only.
- 



- In the case of faulty operation of the centrifuge one shall ask for assistance of service of MPW MED. INSTRUMENTS or its authorized representatives.
- 



- It is not allowed to switch the centrifuge on if it is not installed properly or rotor is not fitted correctly.
- 



- The centrifuge must not be operated in places where explosion hazard exists as it is not explosion-proof.
  - It is not allowed to centrifuge materials capable of generating inflammable or explosive mixtures when subjected to air.
- 



- It is not allowed to subject to centrifugation toxic or infectious materials with damaged leak proof seals of the rotor or test-tube. Proper disinfection procedures have to be carried out when dangerous substances contaminated the centrifuge or its accessories.
- 



- It isn't allowed to open the cover manually in emergency procedure when rotor is still turning.
- 



- It isn't allowed to exceed load limit set by the manufacturer. Rotors are intended for fluids of average homogeneous density equal to 1.2 g/cm<sup>3</sup> or smaller when centrifugation is carried out at maximum speed. When fluids of higher density shall be used, then it is necessary to limit speed (see point 7.3.3 "Maximum load").
- 



- It is not allowed to use the rotors and round carriers with signs of corrosion or other mechanical defects.
  - It is not allowed to centrifuge highly corrosive substances which may cause material impairment and lower mechanical properties of rotor and round carriers.
  - It isn't allowed to use rotors and accessories not admitted by the manufacturer. Let to use commercial glass and plastic test tubes, which are destined to centrifuging in this laboratory centrifuge. One should absolutely not use poor quality elements. Cracking of glass vessels and test tubes could result in dangerous vibration of the centrifuge.
-



- It is not allowed to carry out centrifugation with the rotor caps taken off or not driven tight.
  - It is not allowed to lift or shift the centrifuge during operation, and rest on it.
  - It is not allowed to stay in the safety zone within 30 cm distance around the centrifuge neither leave within this zone some things, e.g. glass vessels.
  - It is not allowed to put any objects on the centrifuge.
- 

## **6. Operation of the centrifuge.**

### **6.1. Mounting of the rotor and accessories.**

1. Connect the centrifuge to mains (master switch at back wall of the centrifuge).
2. Open the cover of the centrifuge pushing the pushbutton COVER. Prior to putting the rotor in one has to check if rotating chamber is free of impurities, e.g. such as dust, glass splinters, residues of fluids that must be taken away.
3. One shall release with special spanner clamp on the motor shaft and fit the rotor on the motor shaft driving it home on the cone.
4. Screw-in the bolt for fixing the rotor (clockwise) and screw it tightly home with the supplied spanner.
5. Put the Cyto-container hangers into rotor.
6. Fill test Cyto-container outside the centrifuge, just before centrifuging.
7. For replacement of the rotor one shall release clamping by several turns of the bolt and then using both hands grab the rotor at opposite sides taking it away from drive shaft by pulling it up. Earlier take the hangers out of the rotor.

### **6.2. Construction and safety measures.**

The centrifuge has rigid self-supporting structure. Housing is made of plastic while front is made of steel sheet. Cover is fixed on steel axles of hinges and from the front is locked with electromagnetic lock blocking possible opening during centrifugation. Bowl forming the rotation chamber is made of acid resistant steel sheet.

### **6.3. Drive.**

Drive constitutes brushless induction motor of low noise level, free of carbon brushes. This solution eliminated the danger of contamination the preparations with carbon dust.

### **6.4. Data input and output.**

Data setting and read-out system forms hermetically closed keyboard with distinctly accessible operation points. Easily readable display signalling individual performed operations facilitates to operator programming of condition of the centrifuge. Operation of the centrifuge is simple and self-evident.

### **6.5. Controls.**

Microprocessor control system being used in the centrifuge ensures the following possibilities of setting of parameters of operation:

- stepwise rotational speed selection within the range from 300 up to 2500 rpm every 100 rpm,
- setting of the centrifugation time within the range from 1 up to 99 minutes,
- selection of "SHORT" short duration operation setting for pre-programmed speed.

## 6.6. Safety devices.

Apart from the above described passive devices and safety measures there exist as well active devices and elements as follows:

### 6.6.1. Cover lock.

The centrifuge can be started only with properly closed cover. The cover can be opened only after stopping the rotor. In the case of emergency opening of the cover during operation the centrifuge will be immediately switched-off and the rotor will be braked until stopping completely. With opened cover, the drive is completely disconnected from power which makes it impossible to start the centrifuge.

#### Emergency cover release

*In the possible case of failure, such e.g. as power failure there exists possibility of manual opening of the cover. On the right side of the housing there is a small opening in which one shall put  $\phi$ 2mm bar or key and push it, and the cover will be opened by itself.*

**CAUTION!** Cover can be released and opened only when rotor is in the rest state.

### 6.6.2. Rest state check.

Opening of the centrifuge cover is possible only with the rotor in the state of rest. This state is being checked by the microprocessor which recognizes and signals the rest state prior to opening the cover with letter **S** (Stop).

## 7. Description of the centrifuge operating elements.

Power switching ON/OFF is carried out with master switch situated on back of the centrifuge. All settings on the centrifuge are done by means of the control panel. Panel comprises control pushbuttons, displays and signalling LEDs.

### 7.1. Control panel.

Control panel placed on front casing wall serves for controlling centrifuge operation. Control panel comprises the following elements:



#### Control panel

- |                            |  |
|----------------------------|--|
| 1. Upper display field     | S: 4 digits (rpm) RCF 4 digits (x g)   |
| 2. Lower display field     | T: 4 digits (min/sec) <b>S</b> (STOP), <b>O</b> (opened cover), <b>U</b> (unbalance)       |
| 3. Error signalling        |  |
| 4. Rotor status signalling | <b>STATUS COVER</b> blinking - rotor rotates,<br>lack of blinking - rotor does not rotate. |

5. Functional key



6. Functional key





7. Functional key





▶ Buzzer serves for signalling function recording and determination of the centrifuge status.

▶  key serves for starting centrifugation program with parameters presented on display,

▶  key serves for:  
- interrupting centrifugation program in any program phase and braking the rotor,  
- saving of preset SPEED and TIME centrifugation parameters,

▶  key serves for opening of the cover,

▶  serve for speed programming,

▶  serve for time programming,

▶  key serves for short duration operation.

## 7.2. Switching the centrifuge on.

After switching power ON the control system calls recently implemented program and displays in relevant fields rotational speed, duration of centrifugation and cover opening status. Provided that rotor in the centrifuge is stopped, it is possible to open the cover by means of COVER key. Stopped rotor status is displayed as a **S** letter symbol in the display field. When this symbol is not already displayed, then one must wait till this rotor stops and the above mentioned symbol appears.

### 7.2.1. Selection of the program.

Control panel can save 1 program preset by the user. Program acceptance consists in pushing STOP key.

### 7.2.2. Start of the program.

After acceptance of the program and checking if rotor was mounted, centrifuge can be started with pushing START key, provided that cover is closed.

### 7.2.3. Emergency stop.

At any time during centrifuging it is possible to interrupt the process and stop the rotor quickly with single pushing of STOP key.

### 7.2.4. End of the centrifuging.

After termination of time of centrifugation preset in the program, braking follows. At the end of deceleration the rotational speed drops at slower rate in order to ensure soft settling of Cyto-container. Stopping is followed by buzzer signal and is displayed by **S** letter symbol. After pushing COVER pushbutton the cover opens and **O** symbol is displayed.

### 7.2.5. Programming.

Programming mode is activated with pushing SPEED and TIME (+) (-) keys after selection of parameters of the program which one would like to save or change. Acceptance of preset parameters is done by pushing STOP key. One can save one program only.

### 7.3. Mathematical relations.

#### 7.3.1. RCF - relative centrifugal force.

RCF acceleration is the acceleration generated by the rotor rotary motion acting upon tested product and it can be calculated according to the formula:

$$RCF = 11.18 * r * (n/1000)^2$$

where **RCF** [x g]; **r** [cm]; **n** [rpm]

Depending on the distance of particles of the tested product from the axis of rotation one can find from above formula minimum RCF, average RCF or maximum RCF. On the basis of preset RCF value and given radius of the bottom in the test-tubes one can calculate from the formula the rotational speed to be set in the program of centrifuging. Selection of the time of sedimentation and the RCF value shall be carried out experimentally for a given product.

Once every 100 rpm electronic circuit automatically calculates and displays averaged RCF value.

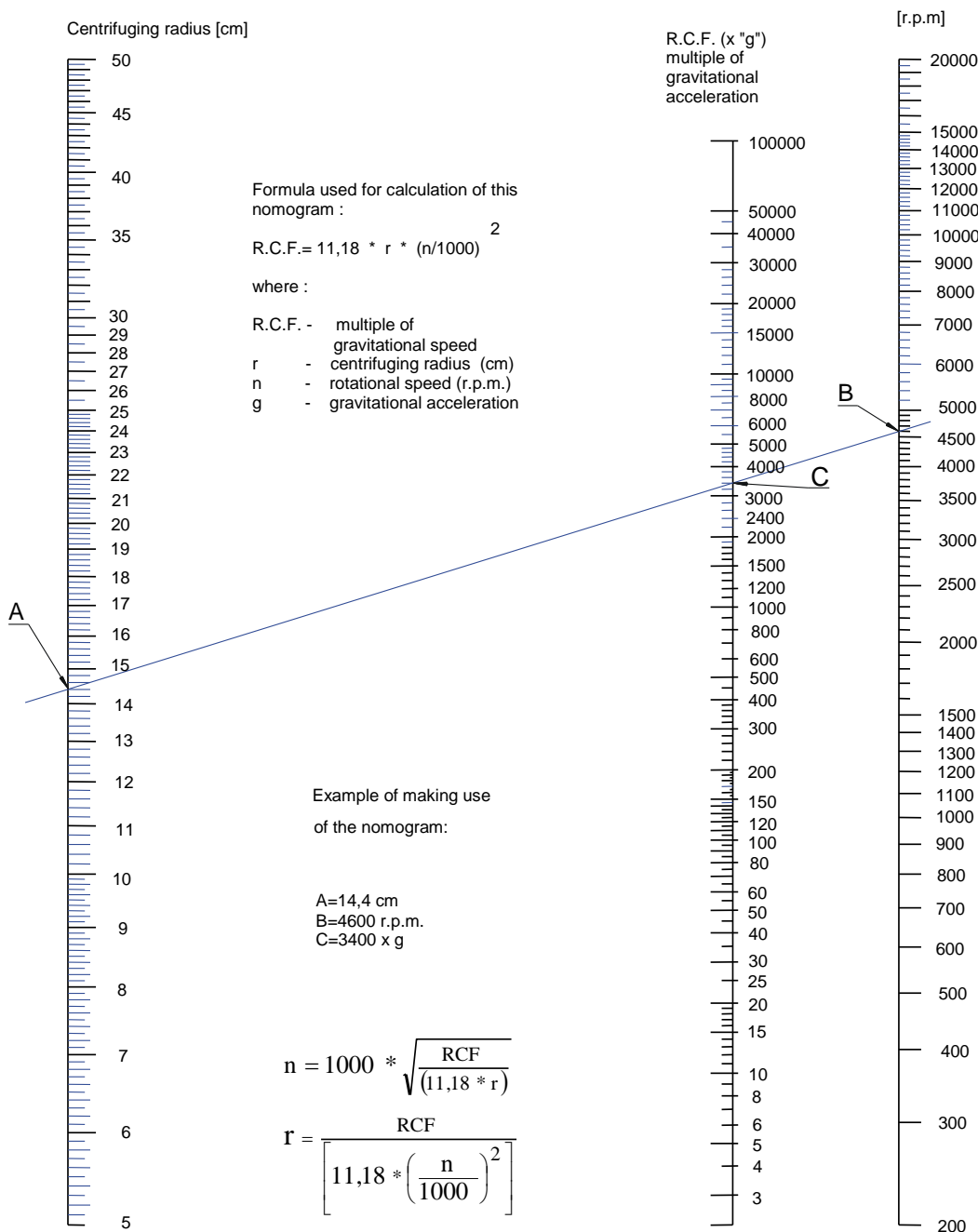

Nomograph

## **8. Cytology kit – Cytoset.**

### **8.1. Intended Use.**

The kit for cytological purposes “Cytoset” is standard equipment for the MPW-223c centrifuge manufactured by MPW MED. INSTRUMENTS. Its intended use is the centrifugal separation of body fluids into fine subconstituent elements from the filtrate. The fine elements are deposited directly on basic microscope slides, while the filtrate is accumulated in special 2.2 ml tubes, following the settling of the particulate matter. The tested physiological fluids constitute a suspension of fine elements in the fluid fraction.

Among them are the following:

- a) natural biological fluids including: cerebrospinal fluid, urines, effusions, serum leaks, joint fluid, leukorrhoea, pus and related others,
- b) suspensions in isotonic smear solutions, tissue punctuates, sputum, rinsings from the bronchi and respiratory pathways and related others.

These suspensions may be tested in order to:

- 1) obtain precipitates of fine matter and the filtrate from the same sample of tested biological suspension,
- 2) obtain just a precipitate of the fine matter through passing of the filtrate into a blotting paper

The cytology kit is essential in medicine and veterinary science, and may also be used in industry as well as technology.

### **8.2. Benefits of “Cytoset”**

- Fast desposition of cells on the microscope slide through centrifugation and the penetration of the filtrate into the blotting/filter paper.
- Possibility of filtrate recovery after the cells have settled on the slide by its automatic collection into a test tube.
- Securing the fluid against its escaping into the centrifugation chamber (avoiding air-born contamination).
- Inserts used as disposable equipment will help prevent infections, contamination of lab personnel or the environment.
- Possibility of having varied size (diameter) areas of cell settlement on the microscope slide.

### **8.3. Work parameters.**

Rotational speed	500 - 2500 rpm
Max. acceleration	750 x g
Max. centrifugation volume	2 ml
Area diameter of settling cells on the microscope slide	Ø 8.7 mm.

#### 8.4. Cytoset contents.

The kit contains a horizontal four-pocket rotor with hangers, into which the complete cyto-container is placed.

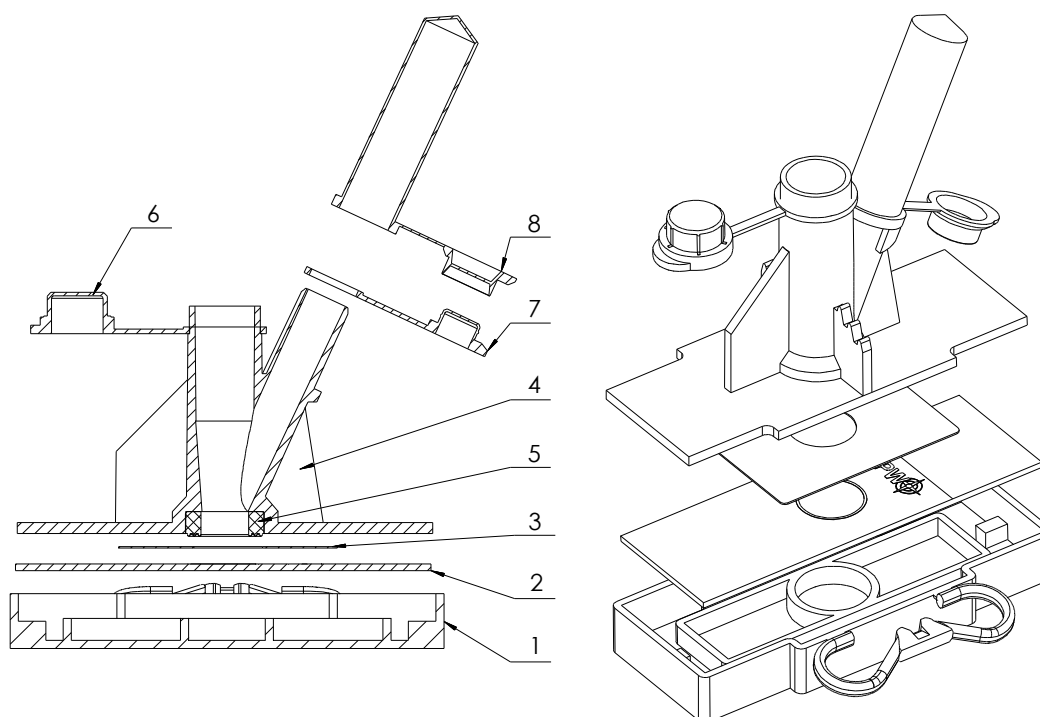

**Drawing No. 1.**  
Cyto-container.

#### The complete insert contains the following:

- base – collection chamber (1),
- basic microscope slide (2),
- blotting/filter card (3),
- cyto-container (4),
- seal  $\varnothing$  8.7 mm (60 mm<sup>2</sup>),
- plug (6),
- plug (7),
- decantation test tube (8).

#### 8.5. Working principle.

During the centrifugation, the cyto container change into a horizontal position, which positioning is then blocked with snap fastening units located in the side arms of the rotor in case of the need to decant the filtrate. Under the centrifugal force the morphotic elements (cell precipitate) are separated from the suspension and settle on the microscope slide. The cell-free filtrate, depending on the method used, is either absorbed by the blotting paper or decanted into a test tube following centrifugation. After the decantation test tube containing the filtrate is removed in order to dry the precipitate on the microscope slide, the test tube is subjected to a second centrifugation.



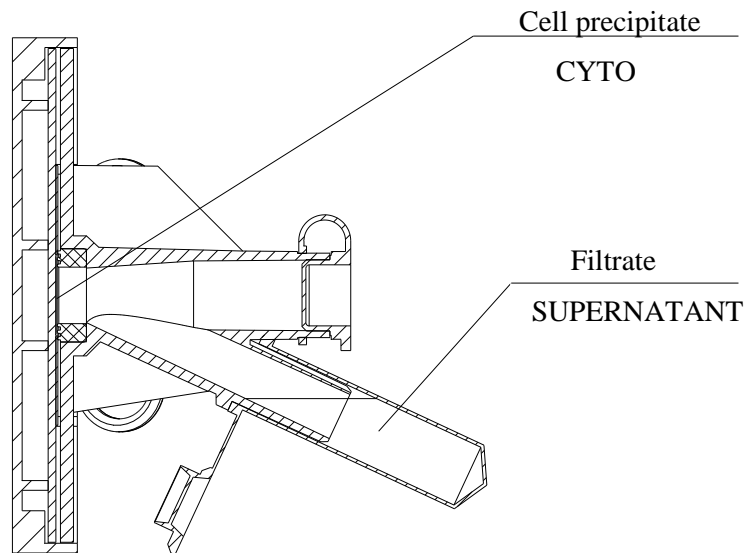

**Drawing No. 2.**

The cyto-container, following the completion of the settling of the morphotic elements on the basic slide centrifugation with filtrate retrieval.

**8.6. Preparation of samples for centrifugation.**

The amount of fluid used in centrifugation depends on its contents of cells, as well as its availability. If the fluid is cell-dense in order to avoid layering of the cells on the slide or their settling too densely, the fluid should be diluted with 0.9 % NaCl solution or PBS.

**8.7. Tabel of dilutions in hematology.**

Number of white cells	Dilution factor	Sample drops	Saline drops
101 - 300	-	20	0
301 - 700	1 : 2	10	10
701 - 1500	1 : 5	4	16
1501 - 3000	1 : 10	2	18

When a cell-poor fluid with a low protein content (about 0.2 mg/ml) is tested there exists a danger, that the centrifuged cells on the slide may be fragmented, as well as the quality of the preparation is often not satisfactory. For that reason, if the filtrate is not needed for further tests, it is recommended that a few drops of blood serum or albumin solutions be added. Samples destined for cyto-centrifugation should be fresh in order to maximize the possibility of getting intact cells.

### 8.8. Preparation of the cyto-container with the passing of the filtrate through blotting paper (with a loss of the filtrate).

- Prepared and labeled basic microscope slide should be inserted into the base-collector. In order to obtain better cell adhesion to the slide it is recommended that the slides be covered with poly-L-lysine, manufactured by “Sigma” – Chemical.
- Place the blotting paper, with a suitable opening depending on the seal used, on the slide. Use filtration/blotting card with an opening of  $\varnothing$  9.5.
- Place the plugs on the cyto insert.
- Place the complete cyto insert onto the base-collector and symmetrically close the snap-fastening catch.
- Pour the prepared fluid sample into the central cylinder of the cyto-container and close with a plug. The maximum amount of fluid, which the cyto insert can hold is 2 ml. That volume is marked with a line.

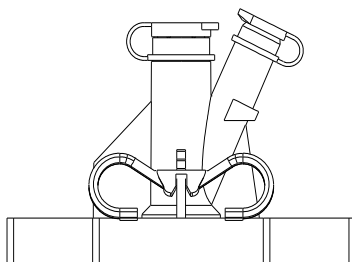

**Drawing No. 3.**

### 8.9. Preparation of the cyto-container with filtrate retrieval.

- Prepared and labeled basic microscope slide should be inserted into the base-collector.
- Place the blotting/filter card with an opening of  $\varnothing$  12.5 over the slide.
- Place the plug and the decantation tube over the cyto-container.
- Place the complete cyto-container over the base-collector and symmetrically close the snap-fastening catch.
- Pour in the tested biological fluid, suspension into the central cylinder of the cyto-container and close with a plug (max. 2 ml).

#### DIAMETER OF OPENINGS IN FILTRATION PAPER

Centrifugation	Seal $\varnothing$ 8.7
With a loss of the filtrate into the filtration paper (card)	$\varnothing$ 9.5
With filtrate retrieval into decantation test tube	$\varnothing$ 12.5

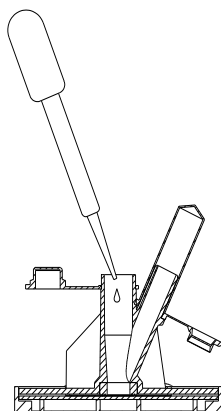

**Drawing No.4.**

### 8.10. Centrifugation parameters.

The selection of parameters for the centrifugation is dependent on the type of the preparation tested and the resistance of the cells to the level of acceleration. Delicate cells require low acceleration (500 rpm), in order to maintain their microscopic structure.

Sample centrifugation time is 3÷15 minutes, on the average. For cerebrospinal fluid 500÷1500 rpm are recommended.

### 8.11. Steps in the use of centrifuge with the “CYTOSET” kit

- Place the centrifuge at the work station.
- Plug into the power supply (socket with grounding).
- Press the POWER switch.
- Open the lid by pressing the lid-opening button.
- Place the “Cytoset” rotor onto the sleeve and with a six-angle wrench turn the clamp until it will not turn any more.
- Place the hangers (9) into the rotor in the suitable position for the method used:
  - a) when losing the filtrate into the blotting paper put the hanger (9) with the peg (10) from the side arm side of the rotor without the snap (on the figure, rotor pocket 2 and 4);
  - b) when recovering the filtrate from the decantation tube, place the hanger (9) with the peg (10) at the side of the rotor side arm with the snap (11) (on the figure, rotor pocket 1 and 3);
- Place the complete cyto-containers filled with fluid into the hangers (minimum of two inserts in opposite pockets).
- Close the lid of the centrifuge.
- Set the centrifugation parameters (time, speed) and start the centrifuge according to the instruction manual the timer will stop the centrifuge after the required time has elapsed.
- An earlier stop may be done by pressing “STOP”.

#### 8.11.1. Rotor with hangers.

- When the centrifuge has signalled the end of centrifugation open the lid.
- Remove the insert in the position, in which it is located in the rotor, pay particular attention to the inserts with the decantation tube, which should be in the centrifugation position with the test tube facing down.

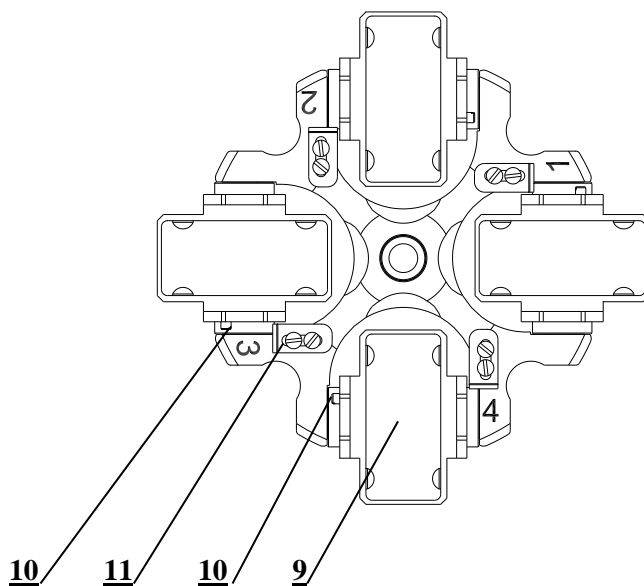

**Drawing No. 5.**

### 8.12. Procedure after centrifugation, when the filtrate is lost.

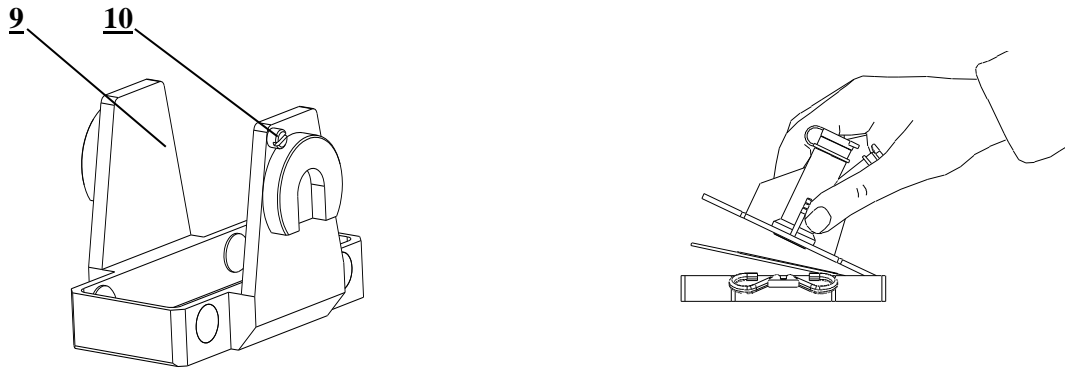

**Drawing No. 6.**

Take out the insert from the mounting of the rotor in the horizontal position. The cyto-container should not be tipped, to avoid the possibility of the spillage of the filtrate from the base-collector, which has not been absorbed by the blotting paper. Place the cyto-container on a piece of blotting paper, which has one foiled side, and open it by lifting the snaps of the catch. Take the microscope slide out by lifting the insert at an angle of 45°. With forceps, take off the blotting card. Dry the tested filtrate, permeabilize in 96 % ethyl alcohol, and then stain with a method of choice. The used elements of the insert should be placed in a sanitary bag for plastics.

### 8.13. Procedure following centrifugation, with the filtrate retrieved.

Take the cyto-container from the blocked hanger of the rotor in the centrifugation position, keeping the decantation test tube tilted down. With a gentle twisting motion we remove the decantation tube and close it with a plug. Place the cyto-container on single-side foiled blotting paper and open the snaps of the catches. Remove just the cyto container by lifting it up and place another blotting paper with an opening of 12.5 onto the slide, while trying not to move the remaining sample drop with the suspension. Put on the cyto-container and close the snaps. Then, in order to dry the sample, spin again for 3 min. with the rpm set previously. Following the centrifugation remove the cyto-container from the hanger, place onto blotting paper with one side foiled and open the the insert by lifting the snaps of the catches. Take out the microscope slide by tilting the insert at an angle of 45°. Remove the filtration paper using forceps. Dry the tested precipitant with 96 % ethyl alcohol and then stain with a technique of choice. The used cyto-container should be placed in a sanitary bag for plastics, in order to reduce the danger of personnel and environment contamination.

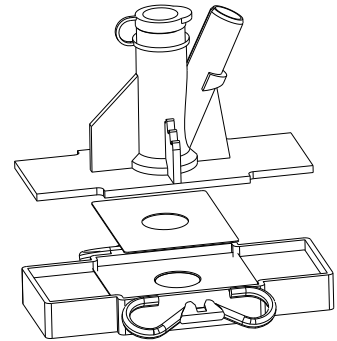

**Drawing No. 7.**

### 8.14. General view of Cytology kit – Cytoset.

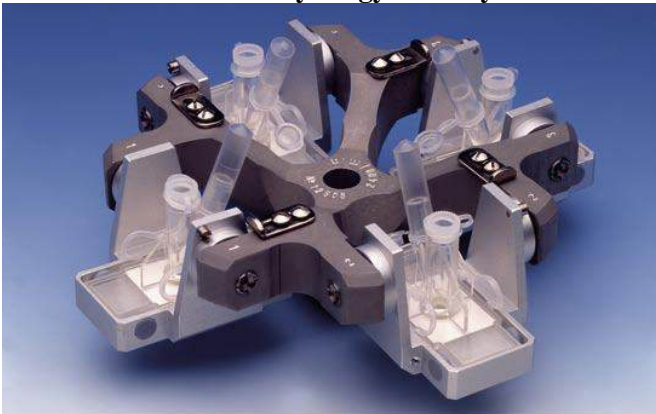

**Drawing No. 8.**

## 9. Cleaning, disinfection, maintenance.

**CAUTION!!!** Use safety gloves for operations specified below.

### 9.1. Cleaning of the centrifuge.

Prior to start of cleaning and disinfection of the centrifuge one shall put the safety gloves on. For cleaning shall be used water with soap or other water soluble mild detergent. One should avoid corrosion inducing substances and aggressive substances. It is prohibited to use alkaline solutions, inflammable solvents or agents containing abrasive particles.



***In the case the user decides to use centrifuge and equipment cleaning methods other than the ones described in this manual, the user shall contact the device manufacturer in order to check whether the cleaning method chosen does not damage the device.***

### 9.2. Cleaning of the accessories.

In order to ensure safety operation one shall in regular way carry out periodical maintenance of the accessories. In the case of observation of surface damage, crevice or other change, as well the corrosion, given part (rotor, clamp, etc.) shall be immediately replaced. In order to prevent corrosion one has to clean regularly the rotor together with the fastening bolt and hangers. Cleaning of the accessories shall be carried out outside of the centrifuge once every week or still better after each use. Then those parts shall be dried using soft fabric or in the chamber drier at 40° C. Especially prone to the corrosion are parts made of aluminium. For cleaning them one should use very neutral agent of pH value within 6÷8 range. It is forbidden to use alkaline agents of pH above 8. In this way substantially is increased useful service life and diminished susceptibility to corrosion. Accurate maintenance also increases service life and protects against premature rotor failures. Corrosion and damages resulting from insufficient maintenance could not be object of claims lodged against the manufacturer.

### 9.3. Sterilization and disinfection of the rotating chamber and accessories.

One can use all standard disinfectants. The centrifuges and accessories are constructed from various materials and one should to take into account possible variety of materials. During sterilization by means of steam one should to consider temperature resistance of individual materials.

## STERILIZATION

	Sterilization* temp. 121 °C, time 20 min	Radiation – β/γ 25 kGy	Gas (ethylene oxide)	Chemical compounds (formalin, ethanol)
<b>PS</b>	no	yes	no	yes
<b>SAN</b>	no	no	yes	yes
<b>PMMA</b>	no	yes	no	yes
<b>PC</b>	yes <sup>1)</sup>	yes	yes	yes
<b>PVC</b>	no <sup>2)</sup>	no	yes	yes
<b>POM</b>	yes <sup>1)</sup>	yes	yes	yes
<b>PE-LD</b>	no	yes	yes	yes
<b>PE-HD</b>	no	yes	yes	yes
<b>PP</b>	yes	yes	yes	yes
<b>PMP</b>	yes	yes	yes	yes
<b>ECTFE/ETFE</b>	yes	no	yes	yes
<b>PTFE</b>	yes	no	yes	yes
<b>FEP/PFA</b>	yes	no	yes	yes
<b>FKM</b>	yes	-	yes	yes
<b>EPDM</b>	yes	-	yes	yes
<b>NR</b>	no	no	yes	yes
<b>SI</b>	yes	no	yes	yes

\* Laboratory vessels have to be exactly cleaned and rinsed with the distilled water before the sterilization in the autoclave. It is always necessary to remove closures from containers!

1) The frequent steam sterilization reduces mechanical durability! PC test tubes may become useless.

2) Except PVC hoses which are resistant to the steam sterilization in the temperature 121 °C.

### Abbreviations of names of characterized plastics

PS:	Polystyrene	ECTFE:	Ethylene/chlorotrifluoroethylene
SAN:	Styrene-acrylonitrile	ETFE:	Ethylene/tetrafluoroethylene
PMMA:	Polymethyl methacrylate	PTFE:	Polytetrafluoroethylene
PC:	Polycarbon	FEP:	Tetrafluoroethylene/perfluoropropylene
PVC:	Polyvinyl chloride	PFA	Tetrafluoroethylene/perfluoroalkylvinylether
POM:	Acetal polyoxymethylenel	FKM	Fluorcarbon rubber
PE-LD:	Low density polyethylene	EPDM:	Ethylene propylene diene
PE-HD:	High density polyethylene	NR:	Natural rubber
PP:	Polypropylene	SI:	Silicon rubber
PMP:	Polymethylpentene		



*For centrifuging infectious materials it is necessary to use hermetically closed buckets, in order to prevent they migration into the centrifuge.*

Rotors, buckets and round carriers can be sterilized in autoclave with temperature 121° – 124° C and pressure 215 kPa during 20 min. In the centrifuge, disinfectants and cleaning agents generally used in medical care should be used (e.g. *Aerodesina-2000, Lysoformin 3000, Melseptol, Melsept SF, Sanepidex, Cutasept F*).



*User is responsible for proper disinfections of the centrifuge, if some dangerous material was spilled inside or outside of the centrifuge.  
During the above mentioned works one must wear safety gloves.*

## 10. Emergency conditions – service.

### 10.1. Troubleshooting.

Majority of faults could be cancelled by switching the centrifuge OFF and then ON. After switching the centrifuge ON shall be displayed parameters of the recently implemented program and buzzer signals consisting of four successive tones. In the case of short-duration power failure the centrifuge terminates cycle.

Please find below the most frequent faults and their repair methods.

<b>1. Lack of display and check buzzer:</b>	<b>Remedies:</b>
<i>Is mains socket live?</i>	<i>Check mains socket fuse.</i>
<i>Is supply cable plugged into mains?</i>	<i>Plug correctly supply cable.</i>
<i>Is input fuse good?</i>	<i>Replace input fuse (rated data on rating plate).</i>
<i>Is master switch switched ON?</i>	<i>Switch ON power supply.</i>
<i>The above was checked and still there is no display active and no check buzzer sound.</i>	<i>Call service.</i>

<b>2. Centrifuge does not start</b>	<b>Remedies</b>
<i>START key pushing does not generate reaction or single tone only</i>	
<i>Rotor stopping symbol S is not displayed yet</i>	<i>Wait till rotor stops and the rotor stopping symbol is displayed</i>
<i>Cover opening symbol O is displayed</i>	<i>Close cover. S symbol that means stop should be displayed.</i>
<i>LED STATUS diode is blinking:</i>	<i>Centrifugation cycle in progress, push STOP key or wait till cycle ends.</i>
<i>Indications show a cycle in progress but the motor does not start</i>	<i>Switch power supply OFF/ON. If fault still persists then call service.</i>
<b>3. Programming function not active</b>	<b>Remedies</b>
<i>It is impossible to record parameter values to memory, last recorded program can not be called. Disturbances on displays possible too.</i>	<i>Call service.</i>
<b>4. Centrifuge starts but does not accelerate</b>	<b>Remedies</b>
<i>E symbol displayed after stopping. Drive overload</i>	<i>Wait for 15 minutes and switch again after opening and closing the cover.</i>
<b>5. One can not open the cover</b>	<b>Remedies</b>
<i>Rotor stopping S symbol not displayed yet, after pushing cover opening key single tone is audible</i>	<i>Rotor is still rotating. Wait for stopping of the rotor and displaying of the S symbol.</i>
<i>Nothing is displayed</i>	<i>Check the centrifuge power supply</i>
<i>Rotor stopping S symbol is displayed, but cover cannot be opened</i>	<i>Call service</i>

## **11. Work safety.**

### **11.1. Work safety inspection procedures.**

From the point of view of operational safety the centrifuge has to be subjected to inspection carried out by authorized service engineer or especially trained experts at least once every year in the state of operational readiness. The reason for more frequent inspection could be for instance more frequent unbalance cases or corrosion inducing environment. Results of inspections, repairs and tests have to be recorded and kept on file. Operating Instruction shall be stored in the centrifuge use place.

### **11.2. Inspection procedures carried out by the operator.**

Operator has to pay special attention to the fact that the centrifuge parts important because of safety reasons are not damaged.

This remark is specifically important for:

1. Motor suspension
2. Motor shaft concentricity
3. Centrifuge accessories and especially structural changes, corrosion, preliminary cracks, abrasion of metal parts.
4. Screw joints.
5. Inspection of the rotor assembly.

## **12. Conditions of repairs.**

Manufacturer grants to the Buyer a guarantee on conditions specified in the Guarantee Certificate. Buyer forfeits the right to guarantee repair when using the device inconsistently with the Operating Instruction provisions, when damage resulted from the User's fault. Repairs should be carried out in authorized service workshops granted with the MPW Certificate. The centrifuge shall be sent to repair after decontaminating disinfection.

Information about authorized service workshops could be obtained from the Manufacturer, i.e. "MPW MED. INSTRUMENTS" in Warsaw, Poland,  
46, Boremlowska Street,  
Tel. + 48 22 610 81 07

## **13. Manufacturer's data.**

### **MPW MED. INSTRUMENTS**

46 Boremlowska Street  
04-347 Warsaw/Poland

tel.           +48 22 610 56 67   sales department,  
                  +48 22 610 81 07   service  
fax            +48 22 610 55 36  
e-mail:       mpw@mpw.pl  
                  www.mpw.pl

## **14. Information about Distributor.**

<b>DISTRIBUTOR:</b>          
---



## 15. Table of chemical resistance to the interaction of various categories of reagents of plastics

Groups of the substance in temp. 20°C	PS	SAN	PMMA	PC	PCV	POM	PE-LD	PE-HD	PP	PMP	ECTFE	PTFE	FKM	EPDM	NR	SI
											ETFE	FEP				
												PFA				
Aldehydes	-	-	o	o	-	o	-	+	+	o	+	+	+	+	o	o
Cyclic alcohols	+	+	+	+	+	+	+	+	+	+	+	+	-	+	+	+
Esters	-	-	-	-	-	-	+	o	o	o	+	+	-	o	o	o
Ether	-	-	-	-	-	+	+	o	o	-	+	+	-	-	-	-
Ketones	-	-	-	-	-	+	o	o	o	o	o	+	-	o	-	-
Strong or concentrated acids	o	-	-	-	+	-	+	+	+	+	+	+		+	-	-
Weak or diluted acids	o	o	o	o	+	-	+	+	+	+	+	+	+	+	o	o
Oxidizing acids or oxidizing substances	-	-	-	-	-	-	-	-	-	-	+	+	o	o	-	-
cyclic hydrocarbons	-	-	o	o	+	+	+	+	+	o	+	+	o	-	-	-
Ahs	-	-	-	-	-	+	+	o	o	-	+	+	o	-	-	-
Haloid hydrocarbons	-	-	-	-	-	+	+	o	o	-	+	+	o	-	-	-
Alkalis	+	+	-	-	+	+	+	+	+	+	+	+	o	+	+	o

### + = very good chemical resistance

Permanent action of the substance does not cause damage through 30 days. The material is able to be resistant through years.

### o = chemical resistance of good to limited

Continuous action of the substance causes insignificant and partly reversible damage through the period of 7-30 days (e.g. puffing up, softening, reduced mechanical durability, discolouring).

### - = limited chemical resistance

The material should not have the continuous contact with the substance. The immediate occurrence of damage is possible (e.g. the loss of mechanical durability, deformation, discolouring, bursting, dissolving).

### Abbreviations of names of characterized plastics

<b>PS:</b>	Polystyrene	<b>ECTFE:</b>	Ethylene/chlorotrifluoroethylene
<b>SAN:</b>	Styrene-acrylonitrile	<b>ETFE:</b>	Ethylene/tetrafluoroethylene
<b>PMMA:</b>	Polymethyl methacrylate	<b>PTFE:</b>	Polytetrafluoroethylene
<b>PC:</b>	Polycarbonate	<b>FEP:</b>	Tetrafluoroethylene/perfluoropropylene
<b>PVC:</b>	Polyvinyl chloride	<b>PFA</b>	Tetrafluoroethylene/perfluoroalkylvinylether
<b>POM:</b>	Acetal polyoxymethylenel	<b>FKM</b>	Fluorcarbon rubber
<b>PE-LD:</b>	Low density polyethylene	<b>EPDM:</b>	Ethylene propylene diene
<b>PE-HD:</b>	High density polyethylene	<b>NR:</b>	Natural rubber
<b>PP:</b>	Polypropylene	<b>SI:</b>	Silicon rubber
<b>PMP:</b>	Polymethylpentene		

## DECLARATION OF CONFORMITY

Product

Laboratory centrifuge

Model

MPW-223c

Product classification on the basis of  
the Directive 98/79/EC

Non classified to list A or B and not for  
self-testing

**Product complies with the requirements:**

• **Directive 98/79/EC (IVD), including the requirements of harmonised standards:**

PN-EN ISO 13485:2012

PN-EN ISO 18113-3:2011

PN-EN ISO 13485:2012/AC:2013-03

PN-EN 61010-2-101:2005

PN-EN 13612:2006

PN-EN 61326-2-6:2013-08

PN-EN ISO 14971:2012

PN-EN ISO 62366:2008

• **selected harmonized standards of Directive 2006/95/EC (LVD):**

PN-EN 61010-1:2011

PN-EN 61010-2-020:2008

• **Directive 2004/108/WE (EMC)**

• **standard PN-EN ISO 15223-1:2012**

CZŁONEK ZARZĄDU PREZES ZARZĄDU

*Wojciech Nojszewski*

*mgr Hanna Maltzewska*

„MPW MED. INSTRUMENTS”  
SPÓŁDZIELNIA PRACY  
w Warszawie

Warsaw, 13.11.2014

„MPW MED. INSTRUMENTS”  
SPÓŁDZIELNIA PRACY

Warsaw, 46 Boremlowska Street  
Quality policy in line with ISO 9001:2008

Certifying authority



nr 10.223c.03

# DECLARATION OF DECONTAMINATION

In order to protect our employees please fill out the declaration of decontamination completely before sending centrifuge to the manufacturer (repair).

1. **Device**

– type: .....

– serial No.: .....

2. **Description of decontamination**

(see user manual)

.....

.....

.....

.....

3. **Decontamination carried out by:**

– name: .....

4. **Date and signature**

.....

## DECLARATION OF DECONTAMINATION

In order to protect our employees please fill out the declaration of decontamination completely before sending centrifuge to the manufacturer (return).

5. **Device**

– type: .....

– serial No.: .....

6. **Description of decontamination**

(see user manual)

.....

.....

.....

.....

7. **Decontamination carried out by:**

– name: .....

8. **Date and signature**

.....