

Instruction Manual

pH / ION METER (F-72G)



■ Preface

This manual describes the operation of the following instrument.

Brand (pet name): LAQUA
Series name: Benchtop pH/Water Quality Analyzer
Model: F-72G
Model description: pH/ION METER

Be sure to read this manual before using the product to ensure proper and safe operation of the instrument. Also safely store the manual so it is readily possible whenever necessary.

Product specifications and appearance, as well as the contents of this manual are subject to change without notice.

● Warranty and responsibility

HORIBA Advanced Techno Co., Ltd. warrants that the Product shall be free from defects in material and workmanship and agrees to repair or replace free of charge, at option of HORIBA Advanced Techno Co., Ltd., any malfunctioned or damaged Product attributable to responsibility of HORIBA Advanced Techno Co., Ltd. for a period of one (1) year from the delivery unless otherwise agreed with a written agreement. In any one of the following cases, none of the warranties set forth herein shall be extended;

- Any malfunction or damage attributable to improper operation
- Any malfunction attributable to repair or modification by any person not authorized by HORIBA Advanced Techno Co., Ltd.
- Any malfunction or damage attributable to the use in an environment not specified in this manual
- Any malfunction or damage attributable to violation of the instructions in this manual or operations in the manner not specified in this manual
- Any malfunction or damage attributable to any cause or causes beyond the reasonable control of HORIBA Advanced Techno Co., Ltd. such as natural disasters
- Any deterioration in appearance attributable to corrosion, rust, and so on
- Replacement of consumables

HORIBA Advanced Techno Co., Ltd. SHALL NOT BE LIABLE FOR ANY DAMAGES RESULTING FROM ANY MALFUNCTIONS OF THE PRODUCT, ANY ERASURE OF DATA, OR ANY OTHER USES OF THE PRODUCT.

● Trademarks

Company names and brand names are either registered trademarks or trademarks of the respective companies. (R), (TM) symbols may be omitted in this manual.

■ Regulations

● EU regulations

● Conformable standards

This equipment conforms to the following standards:



EMC:	EN61326-1 Class B, Basic electromagnetic environment
Safety:	EN61010-1
RoHS:	EN50581 9. Monitoring and control instruments

Warning: This product is not intended for use in industrial environments. In an industrial environment, electromagnetic environmental effects may cause the incorrect performance of the product in which case the user may be required to take adequate measures.

● Installation environment

This product is designed for the following environment.

- Overvoltage category II
- Pollution degree 2

● Information on disposal of electrical and electronic equipment and disposal of batteries and accumulators

The crossed out wheeled bin symbol with underbar shown on the product or accompanying documents indicates the product requires appropriate treatment, collection and recycle for waste electrical and electronic equipment (WEEE) under the Directive 2012/19/EU, and/or waste batteries and accumulators under the Directive 2006/66/EC in the European Union.

The symbol might be put with one of the chemical symbols below. In this case, it satisfies the requirements of the Directive 2006/66/EC for the object chemical.

This product should not be disposed of as unsorted household waste. Your correct disposal of WEEE, waste batteries and accumulators will contribute to reducing wasteful consumption of natural resources, and protecting human health and the environment from potential negative effects caused by hazardous substance in products.

Contact your supplier for information on applicable disposal methods.

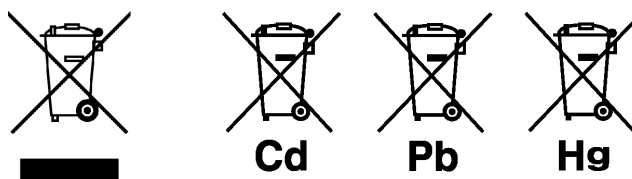

Regulations

- **Authorised representative in EU**

HORIBA UK Limited

2 Dalston Gardens, Stanmore, Middx HA7 1BQ, UK

- **FCC rules**

Any changes or modifications not expressly approved by the party responsible for compliance shall void the user's authority to operate the equipment.

- **Warning**

This equipment has been tested and found to comply with the limits for a Class A digital device, pursuant to part 15 of the FCC Rules. These limits are designed to provide reasonable protection against harmful interference when the equipment is operated in a commercial environment. This equipment generates, uses, and can radiate radio frequency energy and, if not installed and used in accordance with the instruction manual, may cause harmful interference to radio communications.

Operation of this equipment in a residential area is likely to cause harmful interference in which case the user will be required to correct the interference at his own expense.

- **Korea certification**

- **B급 기기 (가정용 방송통신기자재)**

이 기기는 가정용(B 급) 전자파적합기기로서 주로 가정에서 사용하는 것을 목적으로 하며, 모든 지역에서 사용할 수 있습니다.

- **Taiwan battery recycling mark**



廢電池請回收

● China regulation

标记的意义

Meaning of Marking

マークの意味

本标记适用在中华人民共和国销售电器电子产品，标记中央的数字表示环境保护使用期限的年数。(不是表示产品质量保证期间。)只要遵守这个产品有关的安全和使用注意事项，从制造日开始算起在这个年限内，不会给环境污染、人体和财产带来严重的影响。请不要随意废弃本电器电子产品。

This marking is applied to electric and electronic products sold in the People's Republic of China. The figure at the center of the marking indicates the environmental protection use period in years. (It does not indicate a product guarantee period.) It guarantees that the product will not cause environment pollution nor serious influence on human body and property within the period of the indicated years which is counted from the date of manufacture as far as the safety and usage precautions for the product are observed. Do not throw away this product without any good reason.



本マークは、中華人民共和国で販売される電気電子製品に適用され、マークの中央の数字は環境保護使用期限の年数を意味します(製品の品質保証期間を示すものではありません)。この製品に関する安全や使用上の注意をお守り頂く限り、製造日から起算するこの年限内では、環境汚染や人体や財産に深刻な影響を及ぼすことはありません。本製品をみだりに廃棄しないでください。

Regulations

产品中有害物质的名称及含量

Name and amount of hazardous substance used in a product

部件名称 Unit name	有害物质 Hazardous substance					
	铅 Lead (Pb)	汞 Mer- cury (Hg)	镉 Cad- mium (Cd)	六价铬 Hexa- valent chrom- ium (Cr (VI))	多溴联苯 Poly bromo- biphenyl (PBB)	多溴二苯醚 Poly bromo- diphenyl ether (PBDE)
本体 Main unit	×	○	○	○	○	○
电池 Battery	×	○	○	○	○	○
AC适配器 AC adapter ^{*1}	×	○	○	○	○	○
电缆 Cable	×	○	○	○	○	○
支架 Stand ^{*2}	○	○	○	○	○	○
打印机 Printer ^{*2}	×	○	○	○	○	○
电极 Electrode ^{*2}	×	○	×	○	○	○

本表格依据 SJ/T 11364 的规定编制。

This form is prepared in accordance with SJ/T 11364.

○：表示该有害物质在该部件所有均质材料中的含量均在 GB/T 26572 规定的限量要求以下。

Denotes that the amount of the hazardous substance contained in all of the homogeneous materials used in the component is below the limit on the acceptable amount stipulated in the GB/T 26572.

×：表示该有害物质至少在该部件的某一均质材料中的含量超出 GB/T 26572 规定的限量要求。

Denotes that the amount of the hazardous substance contained in any of the homogeneous materials used in the component is above the limit on the acceptable amount stipulated in the GB/T 26572.

*1: 本部件的环保使用期限为10年。 The environmental protection use period of this product is 10 years.

*2: 选配件 Optional products

■ For Your Safety

● Hazard classification and warning symbols

Warning messages are described in the following manner. Read the messages and follow the instructions carefully.

● Hazard classification



This indicates an imminently hazardous situation which, if not avoided, will result in death or serious injury. This signal word is to be limited to the most extreme situations.



This indicates a potentially hazardous situation which, if not avoided, could result in death or serious injury.



This indicates a potentially hazardous situation which, if not avoided, may result in minor or moderate injury. It may also be used to alert against unsafe practices.

● Warning symbols



Description of what should be done, or what should be followed



Description of what should never be done, or what is prohibited

● [DEU] Sicherheitsinformation7

Lesen Sie vor der Verwendung des Produkts unbedingt diese Anleitung, um den ordnungsgemäßen und sicheren Betrieb des Produkts zu gewährleisten. Bewahren Sie die Anleitung sicher auf, damit sie bei Bedarf jederzeit zur Hand ist.

Die Inhalt dieser Anleitung können ohne Vorankündigung geändert werden.

● Installationsumgebung

Dieses Produkt ist nicht zum Gebrauch in industriellen Umgebungen, wie in EN61326-1 definiert, vorgesehen.

In einer industriellen Umgebung können die elektromagnetischen Störungen eventuell zu Produktfehlfunktionen führen. Um dieses Produkt unter solchen Umständen verwenden zu können, muss der Benutzer ggf. angemessene Maßnahmen ergreifen.

Das Produkt ist gemäß EN61010-1 für die folgende Umgebung vorgesehen.

- Überspannungskategorie II
- Verschmutzungsgrad 2

● [FRA] Informations de sécurité

Veillez à lire le présent manuel avant d'utiliser le produit de manière à garantir son utilisation correcte et sûre. De même, rangez le manuel dans un lieu sûr de manière à pouvoir vous y reporter lorsque cela est nécessaire.

Le contenu du présent manuel peut être modifié sans notification préalable.

● Environnement d'installation

Ce produit n'est pas destinés à une utilisation dans des environnements industriels, tels que définis dans la norme EN61326-1.

Dans un environnement industriel, les interférences électromagnétiques peuvent entraîner un dysfonctionnement du produit. Pour utiliser le produit dans ce type d'environnements, l'utilisateur peut avoir à prendre des mesures appropriées.

Le produit est conçu pour l'environnement suivant, tel que défini dans la norme EN61010-1.

- Catégorie de surtension II
- Degré de pollution 2

● [ITA] Informazioni sulla sicurezza

Leggere attentamente questo manuale prima di utilizzare il prodotto al fine di utilizzarlo in modo sicuro e adeguato. Inoltre, conservare in un luogo sicuro il manuale per poterlo consultare se necessario.

Le contenuti di questo manuale sono soggetti a modifiche senza preavviso.

● Ambiente di installazione

Questo prodotto non è stati progettati per essere utilizzati in ambienti industriali, secondo la norma EN61326-1.

In un ambiente industriale, le interferenze elettromagnetiche potrebbero causare un malfunzionamento del prodotto. Per utilizzare il prodotto in tali ambienti, all'utente potrebbe essere richiesto di adottare le contromisure necessarie.

Il prodotto è designato per il seguente ambiente, definito nello standard EN61010-1.

- Categoria di sovratensione II
- Livello di inquinamento 2

● [SWE] Säkerhetsinformation

Se till att du läser denna handbok innan du börjar använda produkten för en korrekt och säker användning av den. Spara sedan handboken på en säker och lättåtkomlig plats så att du kan konsultera den när så behövs.

Innehållet i denna handbok kan komma att ändras utan föregående meddelande därom.

● Installationsmiljö

Detta produkten är ej avsedda för användning i industriella miljöer enligt riktlinjerna i EN61326-1.

Om den används i industrimiljöer kan de elektromagnetiska störningarna orsaka tekniska fel hos produkten. Om produkten ska användas i sådana miljöer kan användaren behöva vidta lämpliga åtgärder för att lösa dessa problem.

Produkten är utformad för användning i följande miljöer, i enlighet med SS-EN 61010-1.

- Överspänningskategori II
- Föroreningsgrad 2

● [SPA] Información de seguridad

Asegúrese de leer este manual antes de utilizar el producto para garantizar un uso correcto y seguro del mismo. Asimismo, guarde de forma segura el manual para que esté disponible siempre que sea necesario.

El contenido de este manual están sujetos a cambios sin previo aviso.

● Entorno de instalación

Este producto está diseñado para su uso en entornos industriales, tal y como se define en EN61326-1.

En un entorno industrial, las interferencias electromagnéticas pueden provocar un funcionamiento incorrecto del producto. Para usar el producto en tales entornos, el usuario debe tomar las medidas adecuadas.

El producto se ha diseñado para el siguiente entorno, definido en EN61010-1.

- Categoría de sobretensión II
- Nivel de contaminación 2

● [POL] Informacje dotyczące bezpieczeństwa

Przed przystąpieniem do użytkowania tego produktu należy dokładnie zapoznać się z niniejszą instrukcją, aby zapewniona była prawidłowa i bezpieczna eksploatacja produktu. Instrukcję przechowywać w bezpiecznym miejscu, aby w razie potrzeby była zawsze dostępna.

Treść niniejszej instrukcji może ulec zmianie bez wcześniejszego powiadomienia.

● Środowisko instalacji

Ten produkt nie są przeznaczone do użytkowania w środowisku przemysłowym, zgodnie z definicją określoną w normie EN61326-1.

W środowisku przemysłowym zakłócenia elektromagnetyczne mogą powodować nieprawidłowe działanie produktów. Możliwe, że aby użytkować produkt w takich środowiskach, użytkownik będzie musiał podjąć stosowne środki zaradcze.

Produkt jest przeznaczony do użycia w poniższym środowisku zdefiniowanym w normie EN61010-1.

- Kategoria przepięciowa II
- Stopień zanieczyszczenia 2

● [NLD] Veiligheidsinformatie

Lees deze handleiding voordat u dit product gebruikt zodat u het op de juiste manier en veilig kunt gebruiken. Bewaar de handleiding goed zodat u hem wanneer nodig kunt raadplegen.

De inhoud van deze handleiding kunnen zonder voorafgaande kennisgeving worden gewijzigd.

● Installatieomgeving

Dit product is niet bedoeld voor gebruik in een industriële omgeving zoals gedefinieerd in EN 61326-1.

In een industriële omgeving kan de elektromagnetische interferentie de werking van dit product storen. Voor gebruik van het product in een dergelijke omgeving moet de gebruiker mogelijk maatregelen treffen om de storing te verhelpen.

Het product is ontworpen voor de volgende omgeving, gedefinieerd in EN 61010-1.

- Overspanningscategorie II
- Vervuilingsgraad 2

● [JPN] 安全情報

ご使用になる前に、本書を必ずお読みください。お読みになった後は必要なときにすぐに取り出せるように大切に保管してください。

本書に記載されている内容は予告なく変更される場合があります。あらかじめご了承ください。

● 設置環境

本製品は、EN61326-1 で定義される工業環境で使用することを想定した製品ではありません。

工業環境においては、電磁妨害の影響を受ける可能性があり、その場合には使用者が適切な対策を講ずることが必要となることがあります。





本製品は、EN61010-1 で定義される以下の環境用に設計されています。





- 過電圧カテゴリー II
- 汚染度 2

For Your Safety

● Safety Precautions

This section provides precautions to enable you to use the product safely and correctly and to prevent injury and damage. The terms of DANGER, WARNING, and CAUTION indicate the degree of imminency and hazardous situation. Read the precautions carefully as it contains important safety messages.

 WARNING	
	Do not use an unspecified AC adapter. Otherwise, it may heat up or be ignited resulting in a fire or an accident.
	Do not disassemble or modify the meter. Otherwise, it may heat up or be ignited resulting in a fire or an accident.
	Fire <ul style="list-style-type: none">• For your safety, make sure to unplug the power plug from the electrical outlet when not in use.• Clear dust on the power plug periodically (a few times a year). If the power supply cord is left plugging into the electrical outlet for a long period of time, electrical tracking may occur due to dust and moisture, and it may result in an ignition or a fire.
	Fire or electric shock <ul style="list-style-type: none">• Do not bundle the power supply cord during use.• Do not damage the power supply cord nor apply an excessive load to it, such as bending and stretching it repeatedly, putting a heavy thing on it.• If it cannot be plugged into an electrical outlet firmly, stop use of the power supply cord. If may result in overheating, a fire, an electrical shock, or breakdown.

 CAUTION	
	Harmful chemicals <p>Some ion electrodes are used with hazardous standard solutions. Handle them with care. If the internal solution comes in contact with the skin, wash it off immediately. If it gets into eyes, flush with plenty of water and then consult a doctor.</p>
	Harmful chemicals <p>The internal solution of an electrode is highly concentrated potassium chloride (3.33 mol/L KCl). If the internal solution comes in contact with the skin, wash it off immediately. If it gets into eyes, flush with plenty of water and then consult a doctor.</p>
	Broken glass <p>Broken glass may cause injury. The outer tube and tip of an electrode are made of glass. Handle them with care.</p>

For Your Safety



CAUTION



Do not use the cable of serial communication, USB, or AC adapter under wet or humid conditions.

Otherwise, it may cause a fire, electric shock, or breakage.

■ Product Handling Information

● Operational precautions

- Only use the product including accessories for their intended purpose.
- Do not drop, crash, or give any physical impact on the instrument.
- Do not immerse the instrument into alcohol, organic solvent, strong acid, strong alkaline, or the like. The instrument body contains ABS resin, acrylic resin, and some rubber parts.
- If the instrument is dropped into water or gets wet, wipe it using soft cloth. Do not heat to dry it with a hair-dryer (or the like).
- Use fingers to press the operation keys or the touch panel. Do not use a hard object like a metal stick or rod.
- Be careful not to let water into the instruction inside. The instrument is not water-proof.
- To disconnect an electrode or interface cable, hold the connector and pull it off. If you pull at the cable, it may cause a breakage.
- The touch panel is capacitance-type. Make sure to turn OFF the power before cleaning the panel. If you wipe it with the power ON, it may cause instrument malfunction.
- RS-232C or USB communication between the instrument and a personal computer may fail because of environmental conditions, such as (radio/electromagnetic) noise.
- Make sure to use the provided power supply cable to power this product.

● Environmental conditions for use and storage

- Temperature: 0°C to 45°C
- Humidity: under 80% in relative humidity and free from condensation

Avoid the following conditions:

- Dusty environment
- Strong vibration
- Direct sunlight
- Corrosive gas environment
- Close to an air-conditioner
- Direct wind

● Transportation

When transporting the instrument, repackage it in the original package box. Otherwise, it may cause instrument breakage.

● Disposal

Standard solution used for the calibration must be under neutralized before the disposal. As for the disposal of the meter, treat it as an industrial waste.

■ Manual Information

● Description in this manual

— **NOTE** —

This interprets the necessary points for correct operation and notifies the important points for handling the product.

— **REF** —

This indicates the part where to refer for information.

— **HINT!** —

This indicates reference information.

● Original language

This is the English translation of an original Japanese document.

Contents

■ Preface	I
■ Regulations	II
■ For Your Safety	VI
■ Product Handling Information	XIII
■ Manual Information	XIV
Chapter 1 Overview	1
1.1 Description of Each Part	1
1.1.1 Rear	1
1.1.2 Display	1
1.1.3 Left Side	2
1.1.4 Right Side	2
1.1.5 Accessories	3
1.1.6 Identification of Manufacturing Date	3
1.1.7 Operation Keys	4
1.1.8 Icons (Icon Bar)	5
1.1.9 Status Icons	6
1.1.10 Meas Screen	7
1.2 Basic Operation of Touch-Panel and Touch-Key	8
1.3 Function and Operation of the Meas Screen	9
1.4 Function and Operation of the CAL Screen	11
1.5 Assembling the Electrode Stand	12
1.6 Connecting the Electrode	13
1.6.1 Electrode Connector	13
1.6.2 Temperature Connector	13
1.7 Connecting the Power Source	14
1.8 Connecting the Printer	14
1.9 Connecting the Personal Computer	15
1.10 Turn ON the Power	16
Chapter 2 Before Measurement (Meter SET)	17
2.1 Meter SET Screen	17
2.2 Auto Hold Setting	17
2.3 Custom Setting	18
2.4 Sample Name Setting	19
2.5 Interval Memory Setting	20
2.6 USB Memory Setting	21
2.7 Printer Setting	23
2.8 Screen Settings	25
2.9 Sound Setting	27
2.10 Language Setting	28
2.11 Security Setting	28
2.12 User Entry/Info Change/Delete	30
2.13 Date Setting	32
2.14 Analog Output Adjustment	33

Contents

2.15	Temperature Sensor Calibration	34
2.16	Resetting to Factory Defaults	35
Chapter 3	pH Measurement	36
3.1	pH Calibration Setting	36
3.1.1	Standard Solution	36
3.1.2	Calibration Points	37
3.1.3	Calibration Interval	37
3.1.4	Checking Before Use	38
3.2	pH Calibration	39
3.2.1	Calibration Preparation	39
3.3	Checking Before Use	42
3.4	Calibration for Custom Selection	43
3.4.1	Calibration Preparation	43
3.5	pH Measurement Setting	44
3.6	Indicated Resolution of pH Measurement Values Setting	44
3.7	Temperature Compensation Setting	45
3.7.1	Solution Temperature Entry in MTC (Manual Temperature Compensation)	45
3.8	Temperature Conversion Function Setting	46
3.8.1	Temperature Coefficient Setting	46
3.9	Alarm Setting	47
3.9.1	Input Alarm, Upper Limit or Lower Limit	47
3.10	Electrode Model Setting	48
3.10.1	Electrode Model Selection	48
3.10.2	Electrode Model Entry	48
3.11	Electrode Lot No. Setting	49
3.12	pH Measurement	50
Chapter 4	ION Measurement	51
4.1	ION Calibration Setting	51
4.1.1	Calibration Points Setting	51
4.1.2	Checking Before Use	52
4.2	ION Calibration	53
4.2.1	Calibration Preparation	53
4.3	Checking Before Use	55
4.4	ION Measurement Setting	56
4.5	ION Measurement Unit Setting	56
4.6	Temperature Compensation Setting	57
4.6.1	Solution Temperature Entry in MTC (Manual Temperature Compensation)	57
4.7	Alarm Setting	58
4.7.1	Input Upper or Lower Limit Values	58
4.8	Electrode Model Setting	60
4.8.1	Ion species Selection	60

Contents

4.8.2 Electrode Model Entry	60
4.8.3 ION Valency Setting	61
4.9 Electrode Lot No. Setting	61
4.10 ION Measurement	62
Chapter 5 mV Measurement	63
5.1 mV Measurement Setting	63
5.2 Temperature Setting	63
5.2.1 Solution Temperature Entry in MTC (Manual Temperature Setting)	64
5.3 Alarm Setting	64
5.3.1 Input Upper or Lower Limit Values	65
5.4 Electrode Model Setting	66
5.4.1 Electrode Model Selection	66
5.4.2 Electrode Model Entry	66
5.5 Electrode Lot No. Setting	67
5.6 mV Measurement	68
Chapter 6 ORP Measurement	69
6.1 ORP Calibration	69
6.2 ORP Measurement Setting	70
6.3 Temperature Setting	70
6.3.1 Solution Temperature Entry in MTC (Manual Temperature Setting)	70
6.4 Alarm Setting	71
6.4.1 Input Upper or Lower Limit Values	71
6.5 Electrode Model Setting	72
6.5.1 Electrode Model Selection	72
6.5.2 Electrode Model Entry	72
6.6 Electrode Lot No. Setting	73
6.7 ORP Measurement	74
Chapter 7 Application Mode	75
7.1 Standard Addition Method Mode	75
7.1.1 Measurement Using Standard Addition Method	75
7.1.2 Known Addition Method and Sample Addition Method	75
7.1.3 General Cautions for Standard Addition Method	76
7.1.4 Standard Addition Method MEAS Screen	76
7.1.5 Known Addition Method (Single) Measurement	77
7.1.6 Known Addition Method (Double) Measurement	78
7.1.7 Sample Addition Method (Single) Measurement	79
7.1.8 Sample Addition Method (Double) Measurement	80
Chapter 8 Periodic Inspection Mode	82
8.1 pH Periodic Inspection Mode Setting	82

Contents

8.1.1 Settings	82
8.1.2 JIS Mode	83
8.1.3 Pharmacopoeia Mode	85
8.1.4 Simulator (X-51) Mode	86
8.2 ION Periodic Inspection Mode Setting	88
8.3 Comment Input	89
Chapter 9 Data	90
9.1 Measured data_All	90
9.2 Deleting Saved Data	90
9.3 Measured data_latest50	91
9.4 Measured data_search	91
9.5 Cal. results_All	92
9.6 Copy all meas. Data	92
9.7 Delete all meas. Data	93
9.8 Delete all cal. data	93
Chapter 10 Specifications	94
10.1 Model Information	94
10.2 Measuring Object	94
10.3 Default Settings	95
10.3.1 Meter Default Settings	95
10.3.2 Measurement Condition Default Settings (Can Be Set per Operator)	96
10.4 Options	100

Chapter 1 Overview

This chapter describes functions and basic operations of the instrument.

1.1 Description of Each Part

1.1.1 Rear

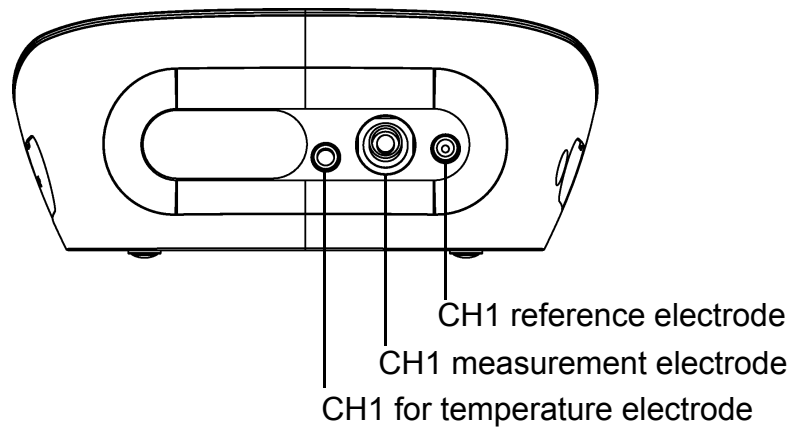

1.1.2 Display

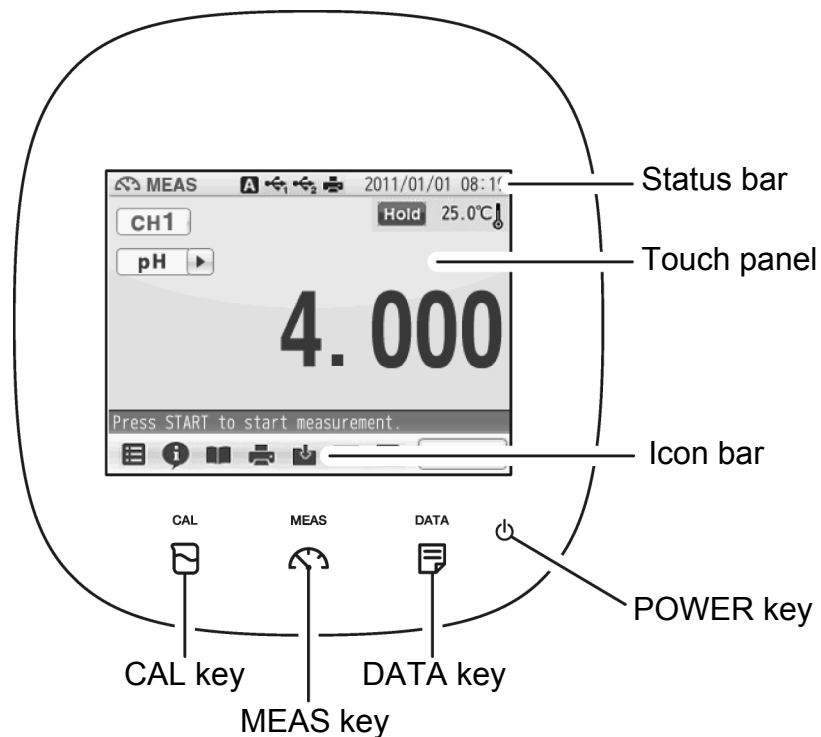

1.1.3 Left Side

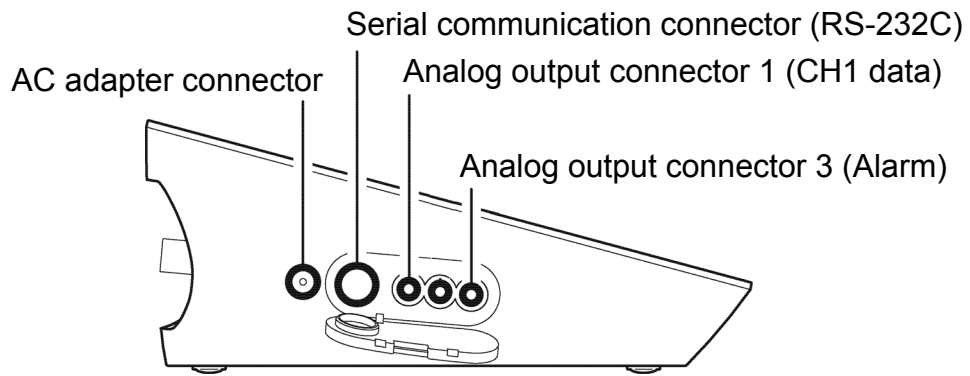

1.1.4 Right Side

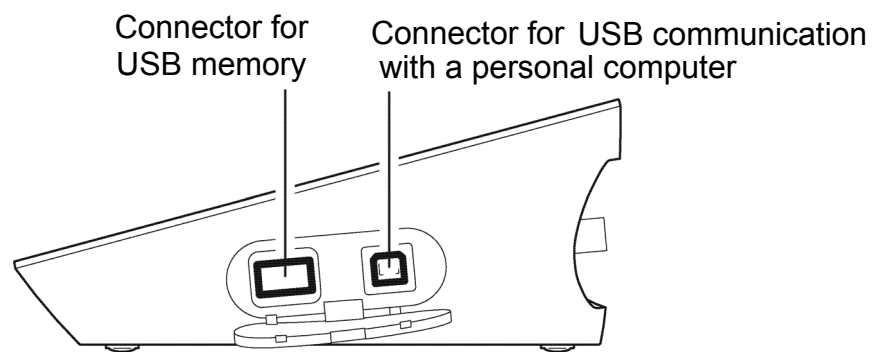

1.1.5 Accessories

Name	Function
AC adapter*	Used to power the instrument.
Electrode stand	Used to move and set electrodes during measurement.
Rubber cover	Protects the instrument side surfaces.
Instruction manual	Instructs the usage of the instrument.
Quick manual	Instructs the operations of calibration and measurement.

*: The AC adapter includes 6 plug adapters.

Referring to the following table, attach the appropriate plug adapter to the AC adapter depending on the country to be used.

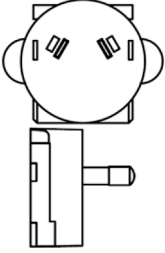
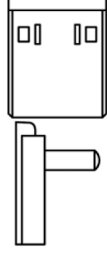
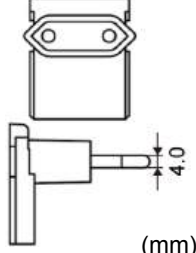
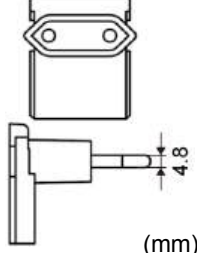
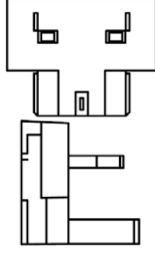
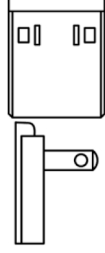
① Australia	② China	③ Europe	④ Korea	⑤ U.K., Singapore	⑥ USA, Canada, Taiwan
					

NOTE

Clock battery (CR-2032) is put into the battery cover at the instrument bottom.

1.1.6 Identification of Manufacturing Date

Manufacturing date can be identified from MFG No. described in the ID label on the backside of the instrument.

Third number from the left in the MFG No. indicates manufacturing year.

Forth alphabet from the left in the MFG No. indicates manufacturing month.





The alphabet is assigned to month according to the table below.

Ex.: ID: AA6A0000 means the device manufactured in 2016 January.

JAN	FEB	MAR	APR	MAY	JUN	JUL	AUG	SEP	OCT	NOV	DEC
A	B	C	D	E	F	G	H	J	K	L	M

1.1.7 Operation Keys



Operation key		Function
	POWER	Turns ON or OFF the power. (Press and hold for 2 seconds or more.)
	CAL	Displays the calibration screen (CAL screen).
	MEAS	Displays the measurement screen (MEAS screen).
	DATA	Displays the data screen (DATA screen).







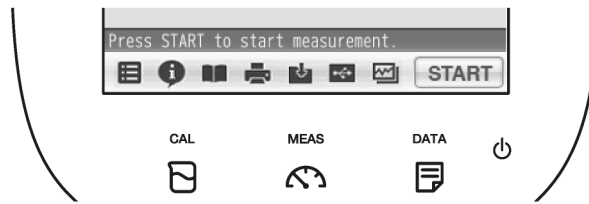

NOTE

The POWER key does not work for 10 seconds after the AC adapter is connected.
Wait for a while after connecting AC adapter.

1.1.8 Icons (Icon Bar)

The icons displayed on the bottom of the touch panel allow you to set up the instrument, check calibration information, and print out and save data.





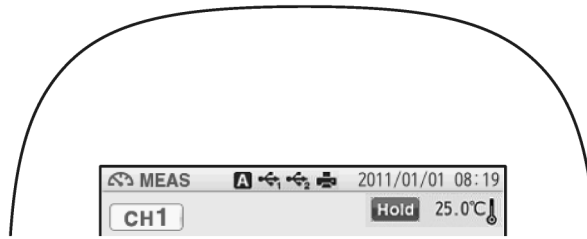

Icon		Function
	Menu	Used to perform measurement, display the Meter SET screen, and switch to the inspection and application modes.
	Information	Used to check calibration information on the MEAS or CAL screen, and application information on the Meter SET screen.
	User's guide	Used to check operation instructions and information about measurement and maintenance.
	Printer	Used to print out measurement or calibration values or saved data when a printer is connected.
	Save in USB	Used to save measured data into a USB memory.
	Save data	Used to save measurement values displayed on the screen into the instrument.
	Trash box	Used to delete calibration data or the data saved in the instrument.
	Operation	Used to start and stop the operations of measurement and calibration, and to change to the instantaneous value display. The icon label depends on the corresponding operation.

1.1.9 Status Icons

The icons displayed on the top of the touch panel show information on the instrument.





Status icon		Function
	Auto hold	Shows that the automatic hold function is ON, and that the end point is determined automatically according to input signals from the electrode based on the pre-selected stability criterion of measurement values. Refer to "2.2 Auto Hold Setting" (P.17).
	Manual hold	Shows that the manual hold function is ON, and that the end point is determined manually. Refer to "2.2 Auto Hold Setting" (P.17).
	USB1 ^{*1}	Shows that the instrument is connected with a personal computer via a USB cable.
	USB2 ^{*1}	Shows that the instrument is connected with a USB data storage media.
	Printer	Shows that the instrument is connected with a printer with a dedicated printer cable.

*1: These icons appear when a USB cable is connected, but it does not always mean that the communication is conducted.

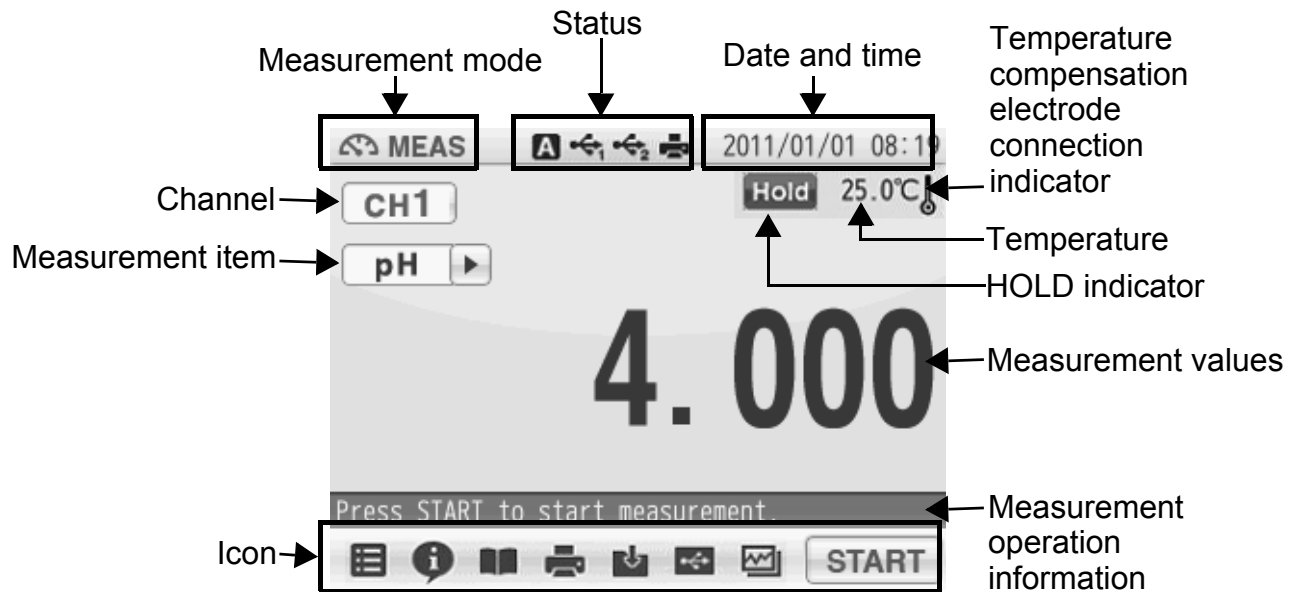
1.1.10 Meas Screen



Indicator	Name	Description
	Temperature compensation electrode connection indicator	<p>Displayed: A temperature compensation electrode is connected. The displayed temperature is the electrode temperature (ATC).</p> <p>Not displayed: The displayed temperature is preset value (MTC).</p>
	HOLD indicator	<p>Not displayed: An instantaneous value is displayed.</p> <p>Blinking: In-process for HOLD</p> <p>Lighting up: HOLD completed.</p>

1.2 Basic Operation of Touch-Panel and Touch-Key

The instrument has touch panel and keys and you can operate it by touching the screen. The 3 basic operations of Tap, Flick, and Drag allow you to operate the instrument intuitively. This section describes the basic operations.

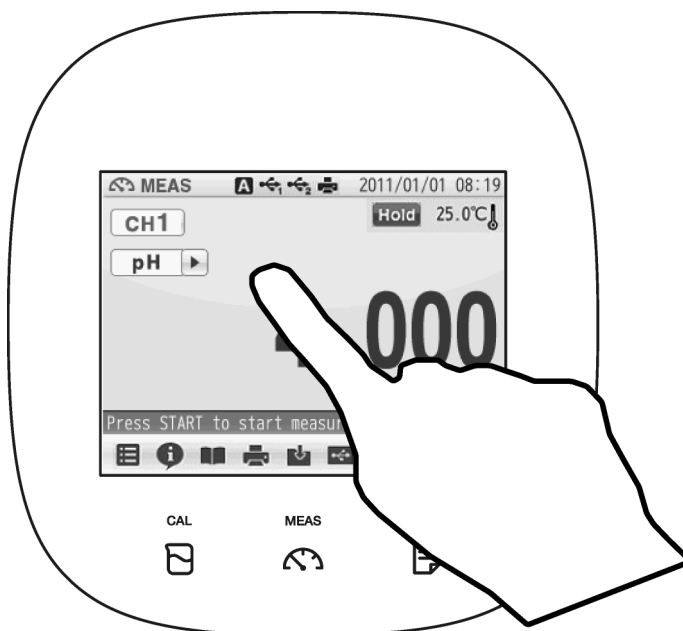

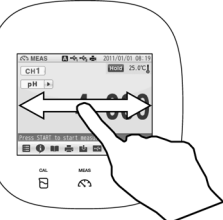
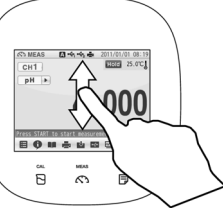
Operation	Description
<p data-bbox="173 1111 229 1137">Tap</p> 	<p data-bbox="440 1111 1219 1173">Tap on the screen lightly once with a finger. Tap a menu item or icon to select it or change settings.</p>
<p data-bbox="173 1386 245 1413">Flick</p> 	<p data-bbox="440 1386 1378 1485">Touch and flick on the screen with a finger. Used to switch to the digital or graph display on the MEAS or CAL screen.</p>
<p data-bbox="173 1684 245 1711">Drag</p> 	<p data-bbox="440 1684 1420 1821">Keep a finger in contact with the screen and drag it on the screen. Used to search a setting item, or measurement data on the DATA screen. When a scroll bar is displayed on the right of the screen, you can scroll the screen by this operation.</p>



1.3 Function and Operation of the Meas Screen

The MEAS screen has three display methods to check variation and tendency of measurement values.

You can shift the screen to the digital, graph or analog screen by flicking it.

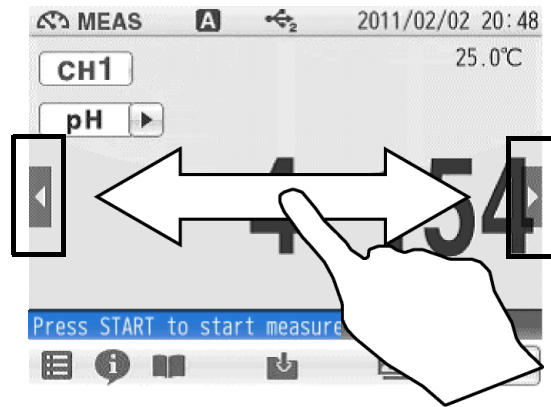
Digital display



If arrows, like  and , appear when you touch the screen, you can flick in the directions to switch the screen display.

Graph display

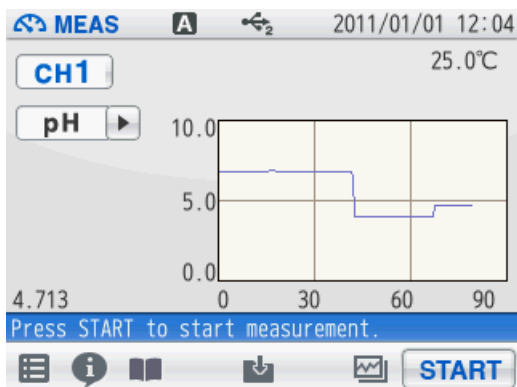

Analog display

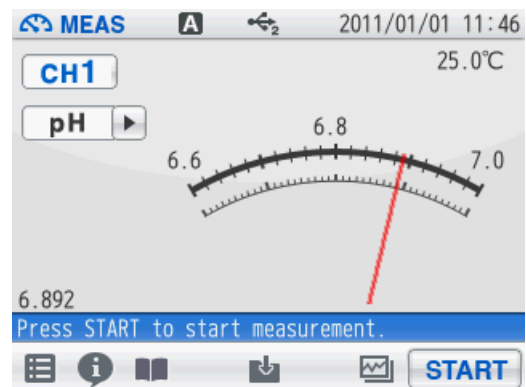

● Graph display

You can change the scale of the vertical axis in the graph display. It allows you to check a small change in measurement values.

The vertical axis is zoomed in.
The displayed range narrows.

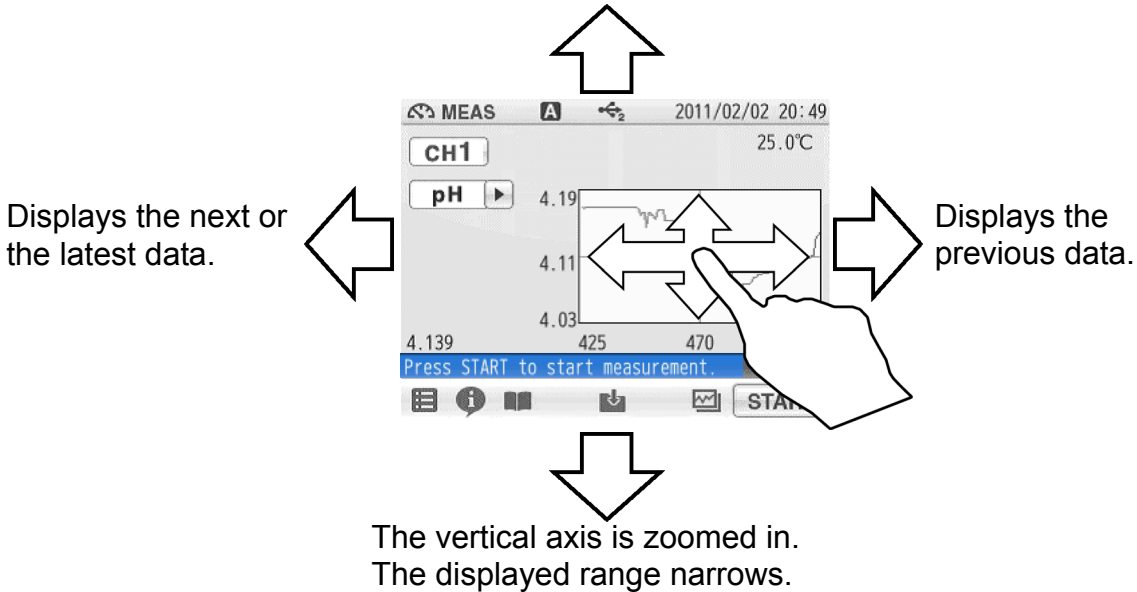

Tap on the screen after the above operations, and the latest data will be displayed in optimized range.

● Analog display

You can change the scale of the vertical axis in the analog display. It allows you to check a small change in measurement values.

The displayed range narrows. It allows you to check the detailed variation of measurement values.

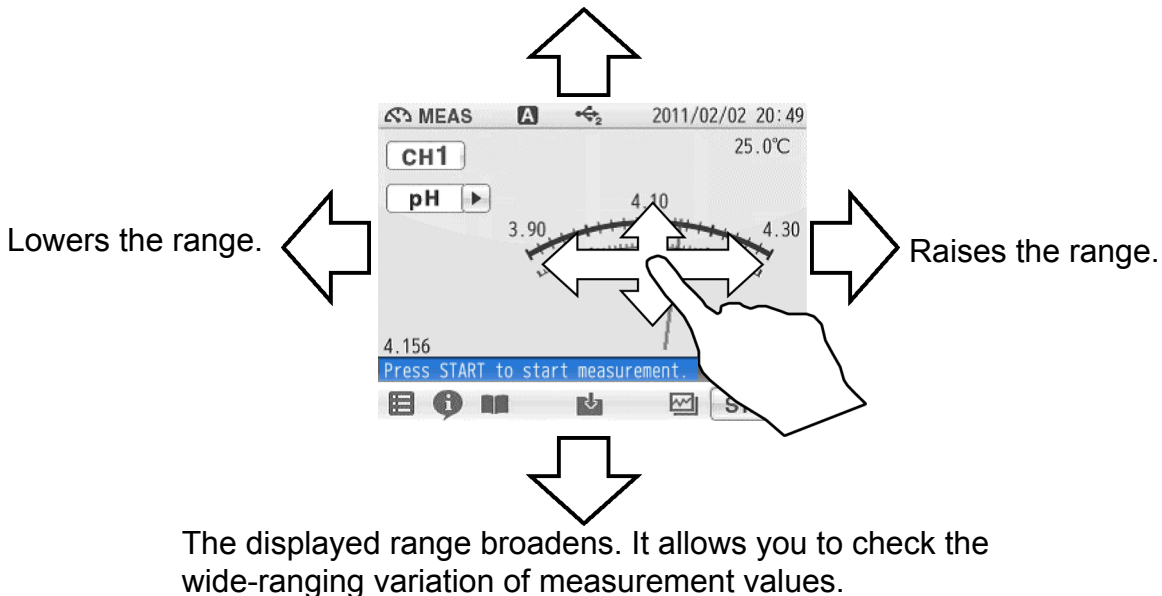

Tap on the screen after the above operations, and the latest data will be displayed in optimized range.

1.4 Function and Operation of the CAL Screen

The CAL screen has 2 functions and allows you to check the stability of readings.

● Stability: Only pH and ION calibration

You can check the change in the indicated value by seeing the stability always displayed under the indicated value in the digital display. The stability value is a deviation between the maximum and minimum values in the last 10 seconds.

For example, you will make a good pH calibration during the stability value is 0.002 or less, though it depends on measurement environment.



● Graph display

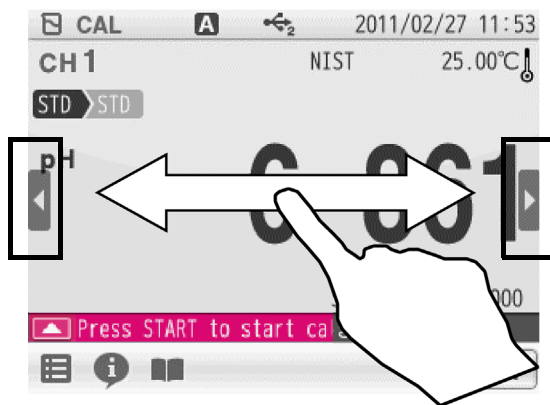

Flick the screen during calibration to shift to the graph display.

Digital display

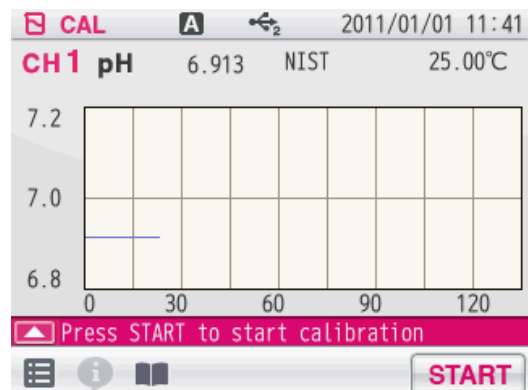

Graph display



If arrows, like  and , appear when you touch the screen, you can flick in the directions to switch the screen display.

You can change the width of graph so that you can easily recognize variation of the indicated value at the graph screen.

The width of measurement range becomes narrower to enlarge the display of measurement values.

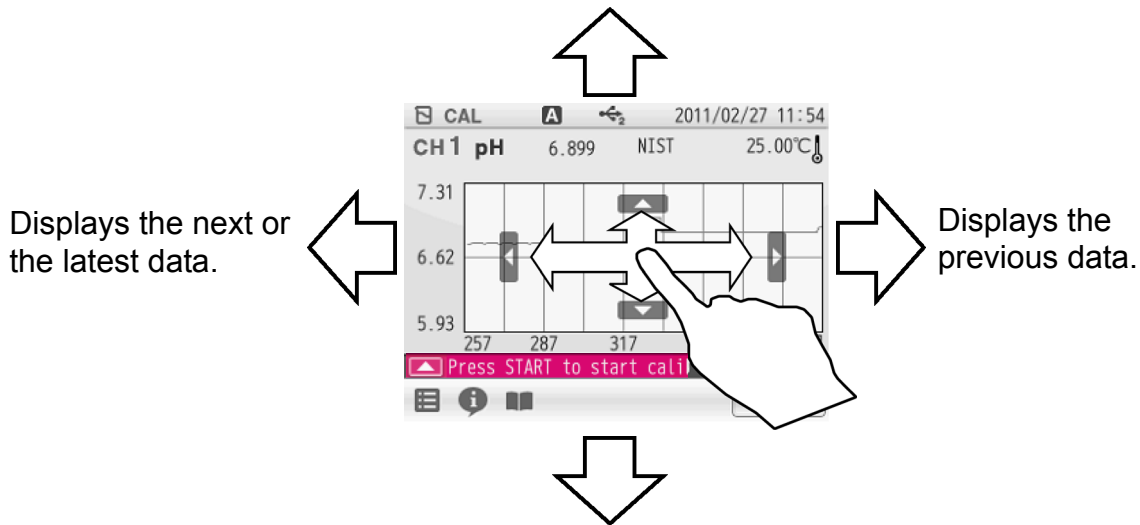

The width of measurement range becomes wider to reduce the display of measurement values.

By tapping the graph screen after you have changed it, the graph screen range optimizes automatically and displays the latest data.

1.5 Assembling the Electrode Stand

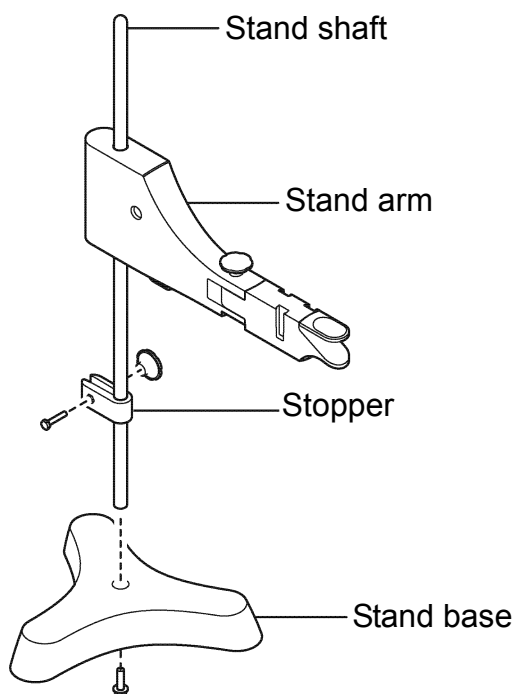

1. Attach the stand shaft to the stand base.
2. Attach the stopper and the stand arm to the stand shaft.

1.6 Connecting the Electrode

1.6.1 Electrode Connector

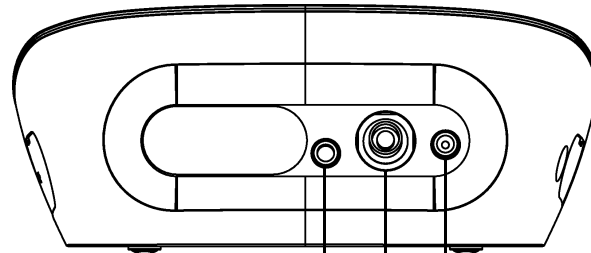

CH1 reference electrode
CH1 measurement electrode
CH1 for temperature electrode

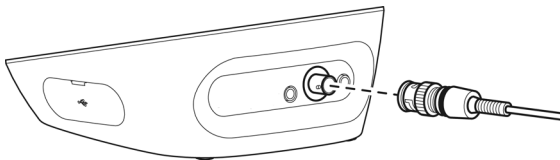

1. Insert the groove of electrode connector by fitting with the connector socket pin of the instrument.

NOTE

Do not insert it with force when the pin and groove are misaligned.

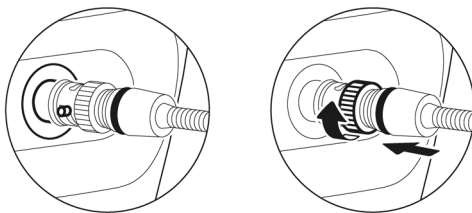

2. Turn the electrode connector to the right along the groove to plug the connector.

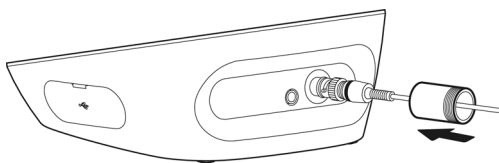

3. Put the connector cover on the connector.

NOTE

Just push the cover on the instrument. Do not screw in it.

1.6.2 Temperature Connector

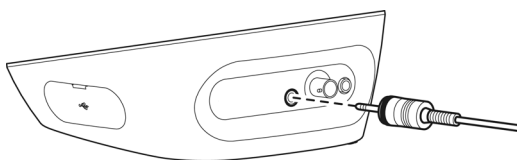

1. Insert the temperature connector into the jack socket on the instrument.

NOTE

If the temperature connector is unconnected or the connection is wrong, the MTC set temperature is displayed as the liquid temperature.

1.7 Connecting the Power Source

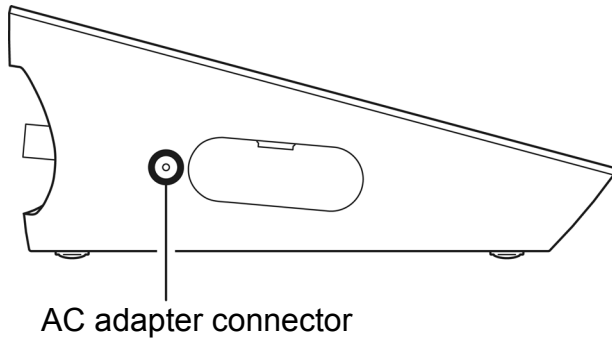

1. Insert the AC adapter cable by fitting with the connector socket of in the instrument.

NOTE

Do not insert the cable with force when the connectors do not match.

1.8 Connecting the Printer

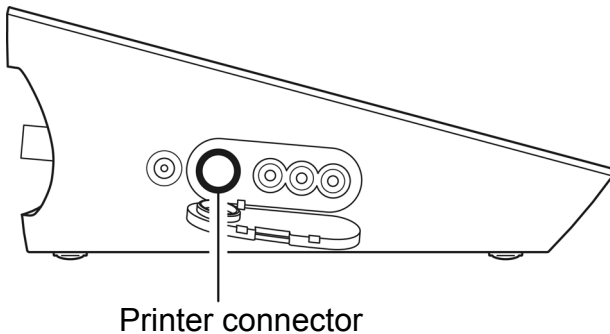

1. Insert the printer cable by fitting with the connector socket of in the instrument.

NOTE

Do not insert the cable with force when the connectors do not match.

The following printer is available.

Printer

CITIZEN CBM-910-24RJ120 V: plain paper type (Parts No.: 3014030146)

CITIZEN CBM-910-24RJ230 V: plain paper type (Parts No.: 3014030147)

Optional printer cable (Parts No.: 3014030148) is required.

NOTE

- Make sure to use the appropriate cable for the printer.
 - Make sure to power OFF the instrument before connecting a printer.
 - When you do not connect a printer with the instrument, disconnect the printer cable and put the rubber cap firmly on the connector socket on the instrument.
-

● Setting the Printer

Refer to the instruction manual of the printer for settings and operations of the printer.

1. Set the DIP switch No. 6 to ON and No. 7 to OFF, and then set printer paper and ink ribbon. Keep the LF key held down.
2. Keep the SEL key held down.
The printer prints output when the SEL key is being pressed.

1.9 Connecting the Personal Computer

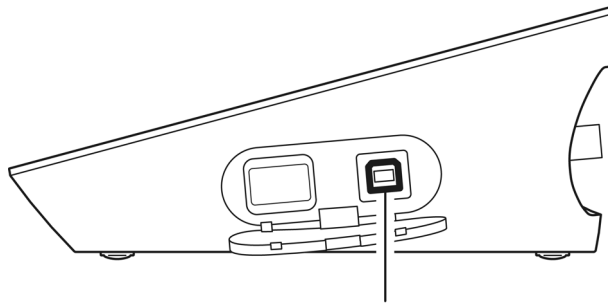

USB connector for personal computer communication

- Use designated cables to connect with a personal computer.
Designated cable
Parts name: USB cable (1 m)
Parts No.: 3200373941
- Make sure that the transfer formats of the measuring instrument and personal computer are same. Otherwise, communication may fail due to a communication error or the online mode start failure. If you change the transfer formats, power OFF both of the instrument and the personal computer once, and then turn ON them again.
- For the details, register with our website and see the free download page of manuals.
- The communication software is subject to change without notice. Use the latest version of communication software uploaded on our website.
The latest version of software is 1.47 at this manual is issued.

1.10 Turn ON the Power

Press and hold the POWER key for 2 seconds or longer.
Following the startup screen, the MEAS screen will be displayed.

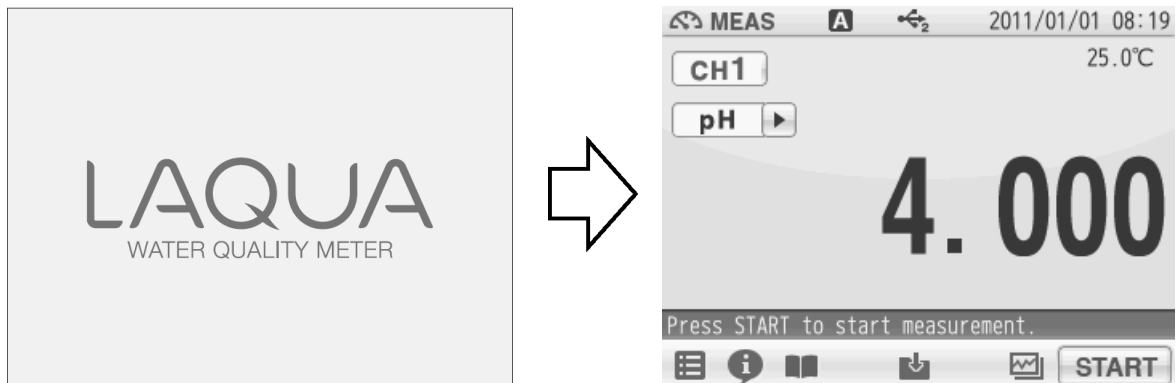

NOTE

- The POWER key does not work for 10 seconds after the AC adapter is connected. Wait for a while after connecting AC adapter.
- If the following message appears on the screen during operation, disconnect the AC adapter and then connect it again and power ON the instrument.

==F-7X series memory manager==
Exception failure occurred.
Please detach AC adapter and restart.

Chapter 2 Before Measurement (Meter SET)

This chapter explains the procedures of the instrument condition setting, which should be performed before measurement.

2.1 Meter SET Screen

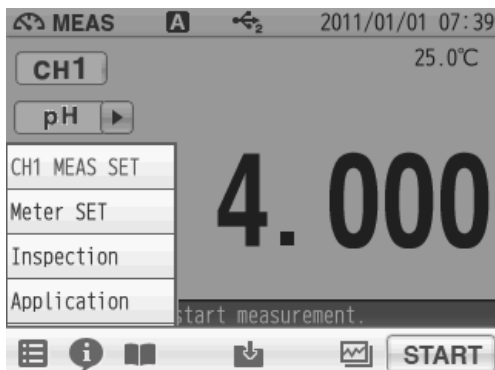

1. Tap  and tap Meter SET.

Meter SET items are displayed.

You will see the remaining items by dragging.



2. Select items and set the conditions.

The setting procedures for each item are explained below.

2.2 Auto Hold Setting



In the AUTO HOLD mode, the instrument judges potential stability automatically to the measurement values. This instrument allows you to select one among the 6 type criteria of potential stability.

1. Change the auto hold settings, tap  on the right of the AUTO HOLD item.
2. Tap  on the right of the HOLD TYPE item.
3. Select the measurement stability condition of the 6 types (EXACT, NORMAL, BRIEF, TIME, CUSTOMIZE, Manual) in the AUTO HOLD selection screen.

To cancel the operation, tap  to return to the previous screen.

Each HOLD condition is described below.

Stability condition		Function			
A	Auto hold	In the AUTO HOLD mode, the instrument judges potential stability automatically to set the measurement values.			
Mode	Measuring target	Content			
		Time (s)	Temperature (°C)	Criteria	【Default】
EXACT	pH	10	2.0	0.005 pH (Equivalent to 0.3 mV)	
	ION, mV, ORP			0.3 mV	
NORMAL	pH	10	2.0	0.015 pH (Equivalent to 1.0 mV)	Default setting of auto hold
	ION, mV, ORP			1.0 mV	
BRIEF	pH	10	2.0	0.050 pH (Equivalent to 3.0 mV)	
	ION, mV, ORP			3.0 mV	
TIME	Common	-	-	Arbitrarily set at 2 s to 999 s.	【10 s】
CUSTOMIZE	pH	Arbitrary setting 2 s to 60 s 【10 s】	2.0	Arbitrarily set at 0.001 pH to 0.100 pH.	【0.005 pH】
	ION			Arbitrarily set at 0.1 mV to 60 mV.	【0.3 mV】
	mV			Arbitrarily set at 0.1 mV to 60 mV.	【0.3 mV】
	ORP			Arbitrarily set at 0.1 mV to 60 mV.	【0.3 mV】
M	Manual hold	Determine an end point manually. (Tap START to hold it.)			

2.3 Custom Setting



We will explain the procedures of CUSTOMIZE setting taking the AUTO HOLD item as an example.

1. Select the CUSTOMIZE of the Hold type to set the stability condition time and the stability condition value.
2. Use the numeric-key screen to enter measurement variations as HOLD criteria for each measurement item.

Tap **<** to return to the previous screen.

2.4 Sample Name Setting

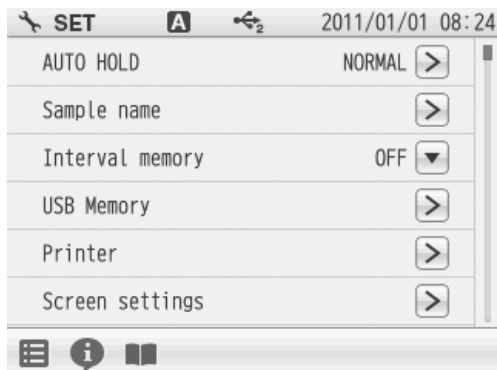

You can set sample names for CH1.

1. Tap on the right of the Sample name item.
2. Tap on the right of the item in the CH1 or the CH2 to enter the sample name.
3. Tap to switch the keyboard entry screen of Alphabet --> Numerical/Symbol. Tap to input in lower-case alphabets. Up to 10 characters can be input.
4. Tap .
The setting applies.
To cancel the settings, tap .
Tap to return to the previous screen.

HINT!

To delete a registered sample name, tap on the right of the sample name, enter nothing, and tap .

2.5 Interval Memory Setting

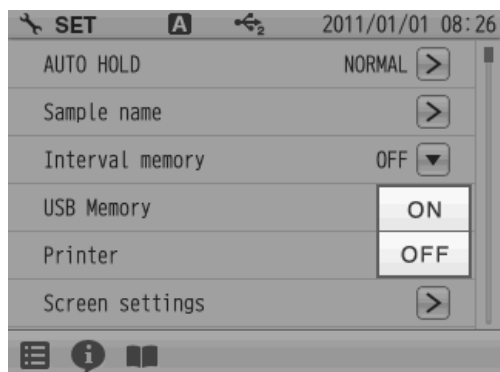



The measured data can be stored at set time intervals.

1. Tap  on the right of the Interval memory item and select ON.

Enter Interval Time



1. Display the Time item when select ON.
Tap  on the right of the Time item.
2. Enter the interval time in the numerical key screen.
(Setting range: 1 second to 999 seconds)
3. Tap  .
The setting applies.
To cancel the settings, tap  .

2.6 USB Memory Setting



Memory data can be written into a USB memory.

1. Tap on the right of the USB Memory item. The USB memory setting screen is displayed. Tap to return to the previous screen.

Simultaneously Memory

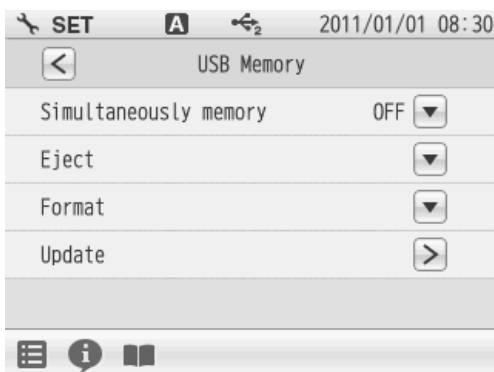

When a USB memory is inserted into the instrument, the data can be written into both the instrument and USB memories at the same time.

1. Tap on the right of the Simultaneously memory item and select ON.

Eject

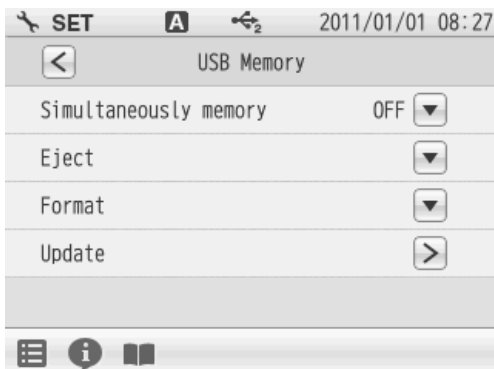

Use this item to eject the USB memory from the instrument.

1. Tap on the right of the Eject item and tap in the execution confirmation screen. To cancel the operation, tap .
2. When the ejection is completed, a notice message will appear. Tap .

NOTE

If you remove a USB memory from the instrument in a way other than mentioned above, data may not be saved correctly or data may be corrupted.

Format

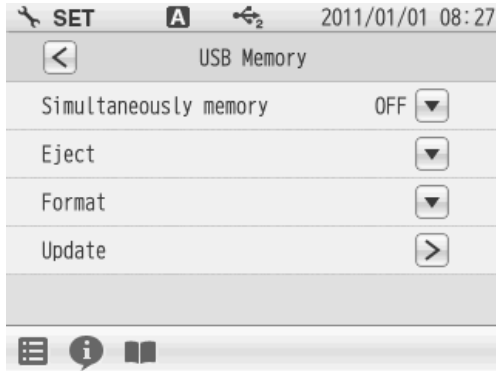

Use this item to format a USB memory in FAT16. Note that formatting deletes all stored data.

1. Tap on the right of the Format item and tap in the execution confirmation screen. To cancel the operation, tap .

NOTE

A message that formatting is in progress appears during formatting. Do not remove the USB memory and do not disconnect the instrument power while this message appears. The instrument and USB memory are being accessed.

2. When the format is completed, a notice message will appear. Tap .

2.7 Printer Setting



The Printer item allows you to set printing contents, etc. effective only when a printer is connected with the instrument.

1. Tap on the right of the Printer item. The printer setting screen is displayed. Tap to return to the previous screen.

Printer Test

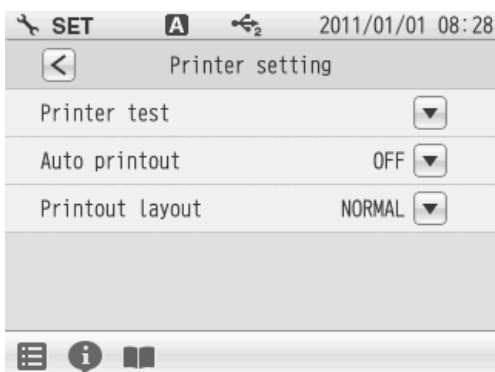

When a printer is connected with the instrument, this item allows you to perform a printer test.

1. Tap on the right of the Printer test item. The printing test is executed. Printout contents

```
!"#$%&'()*+,-./0123
456789:;<=>?@ABCDEFGH
IJKLMNOPQRSTUVWXYZ[
¥]^_`abcdefghijklmnop
qrstuvwxyz{|}
```

Auto Printout

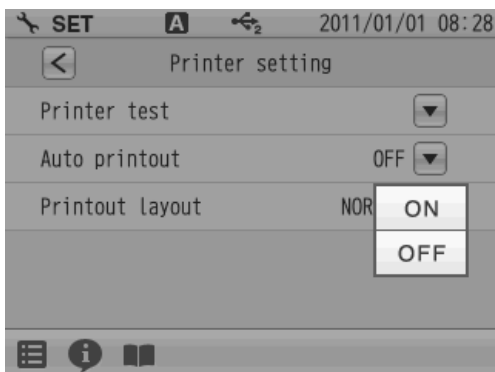

When a printer is connected with the instrument, this item allows you to perform an automatic printer test after measurement or calibration completion.

1. Tap on the right of the Auto printout item and select ON.

Printout Layout

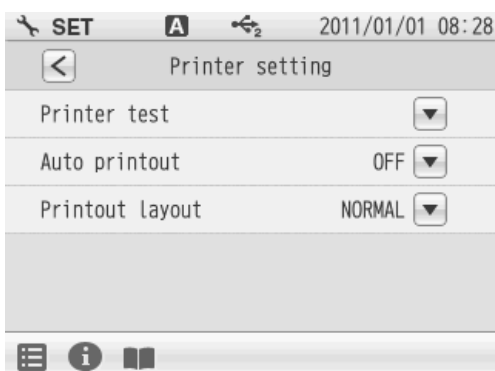

This item allows you to change printing contents.

1. Tap on the right of the Printout Layout item. The printing format screen is displayed. Tap to return to the previous screen.

● When selecting CUSTOMIZE

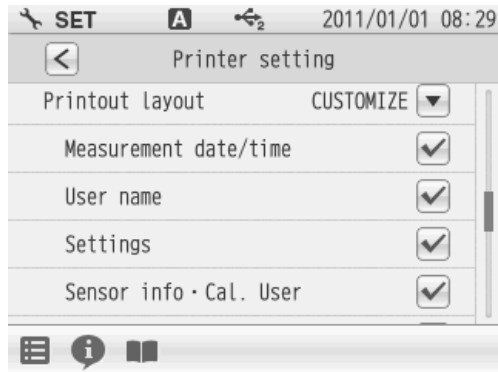

CUSTOMIZE allows you to select items you want to print out among Measurement date/time, User name, Settings, Sensor info·Cal. User.

1. Select CUSTOMIZE from Printout Layout, and tap on the right of the each printing item.
 - is ON: The item is selected.
 - is OFF: The item is not selected.

● Printout example (pH)

The following are the examples of BRIEF, NORMAL and GLP printouts. Contents of results or conditions follow colon mark (:) of each item name. If they exceed 10 characters, the exceeded part is displayed on the next line with right alignment.

When selecting CUSTOMIZE, you can select items that you want to print out among the GLP printing contents. But measurement values are always printed.

BRIEF pH measurement

```
Date       :2011/01/01
Time       :10:10
pH         :7.000
HOLD       :AUTO
Temperature :25.0° C ATC
```

NORMAL pH measurement

```
Date       :2011/01/01
Time       :10:10
pH         :7.000
HOLD       :AUTO
Temperature :25.0° C ATC
Operator   :*GUEST*
Sample ID  :pH buffer
Inst. model :F-7X
Inst. SN   :1234567
Elect. model :9615-10D
Elect. Lot  :1234567
Elect. status:OK
Offset     :-0.1mV
Sensitivity
pH4.008-6.865:100.0%
Cal. Operator :*GUEST*
```

GLP (CUSTOMIZE) pH measurement

```
GLP
Date       :2011/01/01
Time       :10:10
pH         :7.000
mV         : 0.1mV
HOLD       :AUTO
Temperature :25.0° C ATC

Operator   :*GUEST*
Inst. model :F-7X
Inst. SN   :1234567
Elect. model :9615-10D
Elect. Lot  :1234567

Elect. status:OK
Offset     :-0.1mV
Sensitivity
pH4.008-6.865:100.0%
Cal. Operator :*GUEST*

Calibration data
Cal. date   :2011/01/01
Cal. Time   :10:00
pH4.008     :175.7mV
              25.0° C ATC
pH6.865     : 6.7mV
              25.0° C ATC

Signature:
_____
```

Measurement date

Measurement value
(Not be omitted)

Measurement operator

Settings

Electrode Calibration operator

Calibration data

Signature

2.8 Screen Settings



You can change screen settings.

1. Tap on the right of the Screen settings item. The screen settings screen is displayed. Tap to return to the previous screen.

Screen Theme



You can select one among 4 type screen themes; STANDARD, COOL, MONOTONE and KYOTO.

1. Tap on the right of the Screen theme item.
2. Select screen theme. To cancel the operation, tap to return to the previous screen.

Display Brightness



You can adjust the display brightness by tapping or , or by dragging on the scale.

1. Tap on the right of the Display brightness item.
2. When the screen becomes the desired brightness, tap . To cancel the operation, tap to return to the previous screen.

Power Saving Mode

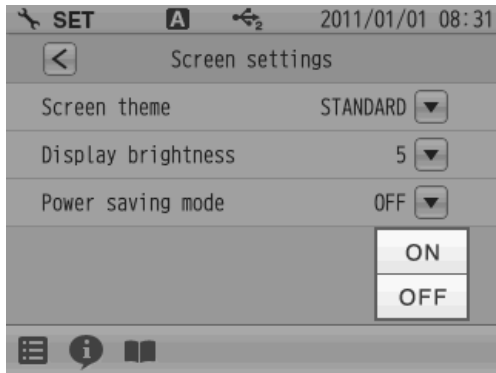

You can set the time for power saving mode.

1. Tap on the right of the Power saving mode item and select ON.

● Back light off time

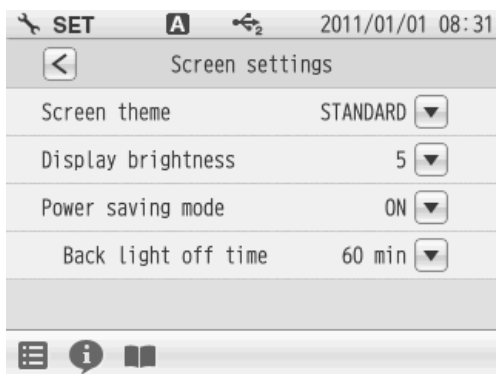

When selecting ON for Power saving mode, the Back light off time item is displayed.

1. Tap on the right of the Back light off time item.
2. Enter the desired time on the numerical key screen. (Setting range: 1 minute to 999 minutes)
3. Tap .
The set time applies.
To cancel the settings, tap .

HINT!

During the power saving mode, the LED lamp above the POWER key lights up. Press the POWER key to exit the power saving mode.

2.9 Sound Setting

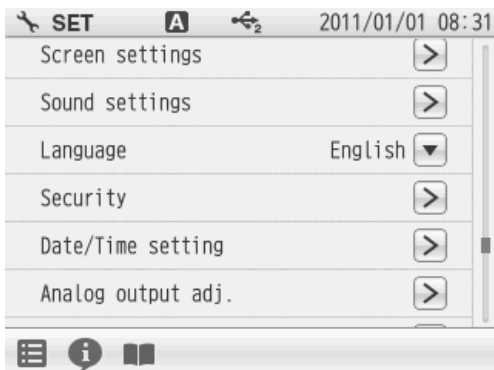

You can change sound settings.

1. Tap on the right of the Sound settings item. The sound settings screen is displayed. Tap to return to the previous screen.

Sound Theme

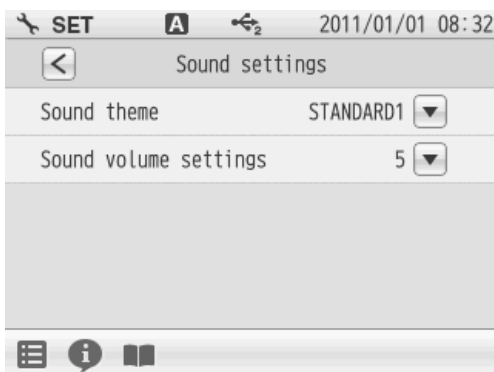

You can select one among 4 type sound themes; STANDARD, COOL, MONOTONE and KYOTO.

1. Tap on the right of the Sound theme item.
2. Select sound theme. To cancel the operation, tap to return to the previous screen.

Volume Setting

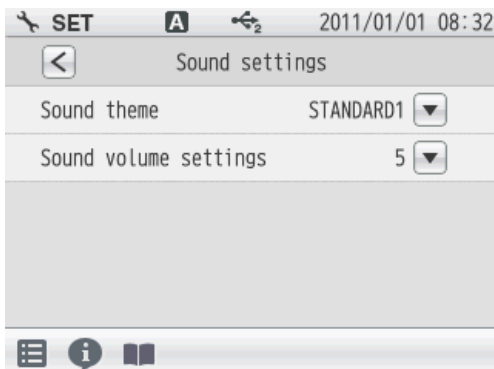



You can adjust the sound volume by tapping or , or by dragging on the scale. When the sound volume is set to 0, the instrument is in the mute mode.

1. Tap on the right of the Sound volume settings item.
2. When the screen becomes the desired volume, tap . To cancel the operation, tap to return to the previous screen.

2.10 Language Setting





You can change language settings.

1. Tap  on the right of the Language item.
2. Select the language.
To cancel the operation, tap .

2.11 Security Setting



Security setting allows you to set a password for an administrator of the instrument. After the setting is ON, the instrument requires you to select an operator name at the startup. Security setting, Date/Time setting, Analog output adj., Temp. calibration and Meter initialization are restricted to the administrator. To change the administrator or operator when the Security setting is ON, power OFF the instrument. At the next startup, the user selection screen appears to allow you change it. 25 administrators or operators in total can be registered.

1. Tap  on the right of the Security item.
The User management screen is displayed.
To cancel the operation, tap  to return to the previous screen.
2. Tap  on the right of the User management item and select ON.

When using the Security setting, administrator registration is required.



1. Tap the blank area at the right of "User name" to display the letter entry screen.
2. Enter the operator name, and tap **ENTER** .
Tap the **A1** to switch the keyboard entry screen of Alphabet and Numerical/Symbol. Tap the **SHIFT** to input in lower-case alphabets. Up to 12 characters can be input.
3. Tap the blank area at the right of "Password" to display the numerical screen.
4. Enter the password, and tap **ENTER** .
The password can be set between 2 and 10 characters.
5. Tap **ENTER** to set.

NOTE

When the Security setting is ON, at least 1 administrator is required for the instrument. Administrators have to keep the password. We recommend registering 2 or more administrators.

Administrator's names are marked with a star on the user selection screen.

2.12 User Entry/Info Change/Delete



When an operator is registered, the operator name can be put in measurement/calibration information, data printouts, data memory.

1. Tap **>** on the right of the User entry/info change/delete item, when user registration, change password and user deletion.
The User entry/info change/delete screen is displayed.

To cancel the operation, tap **<** to return to the previous screen.

User Registration

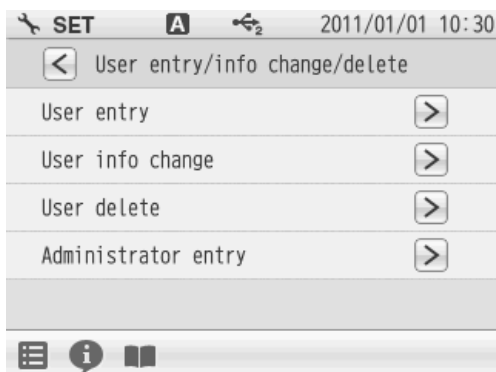

You can register operators.

1. Tap **>** on the right of the User entry item.
2. Tap the blank area at the right of "User name" to display the letter entry screen.
3. Enter the operator name, and tap **ENTER**.
Tap the **A1** to switch the keyboard entry screen of Alphabet and Numerical/Symbol.
Tap the **SHIFT** to input in lower-case alphabets.
Up to 12 characters can be input.
4. Tap the blank area at the right of "Password" to display the numerical screen.
5. Enter the password, and tap **ENTER**.
The password can be set between 2 and 10 characters.
6. Tap **ENTER** to set.

NOTE

When the Security setting is ON, at least 1 administrator is required for the instrument. Administrators have to keep the password. We recommend registering 2 or more administrators.

Administrator's names are marked with a star on the user selection screen.

User Information Changing

Operators can change the password.

1. Tap on the right of the User info change item.
2. Enter the password, and tap .
3. Tap the current password at the right of "Password" to display the numerical-key screen.
4. Enter the password, and tap . The password can be set between 2 and 10 characters.

User Deleting

Only administrators can deregister an operator.

1. Tap on the right of the User delete item.
2. Tap on the right of the operator item.
3. Tap . Tap , when do not deleting.

Administrator Registration

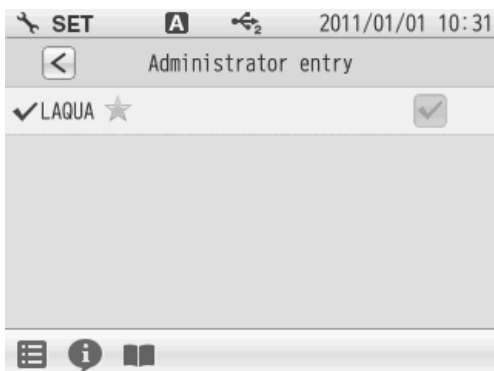

Only administrators can assign/remove an operator as an administrator.

1. Tap on the right of the Administrator entry item.
2. Tap to add a new administrator at the Administrator entry screen. Then, the lights up to show it is in the state of being selected. Tap to change the current administrator to operator. At this time, the lights out to show it is in the state of being unselected.

NOTE

When the Security setting is ON, at least 1 administrator is required for the instrument. Administrators have to keep the password. We recommend registering 2 or more administrators. Administrator's names are marked with a star on the user selection screen.

2.13 Date Setting



You can set the date and time.

1. Tap on the right of the Date/Time setting item.
The Date/Time setting screen is displayed.
Tap to return to the previous screen.

Date

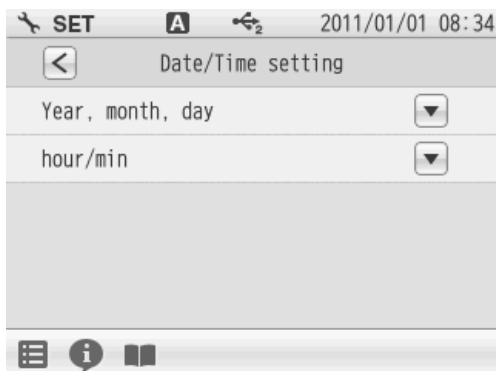

You can set the date.

1. Tap on the right of the Year, month, day item.
 2. Tap or to set the date.
 3. Tap .
- To cancel the operation, tap to return to the previous screen.

Time

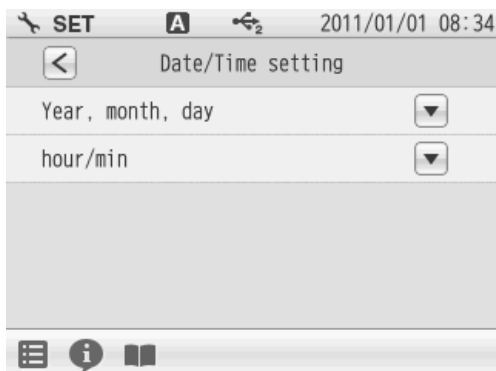

You can set the time.

1. Tap on the right of the hour/min item.
 2. Tap or to set the time.
 3. Tap .
- To cancel the operation, tap to return to the previous screen.

2.14 Analog Output Adjustment



Voltage output can be acquired from the analog output connector located at the instrument side.

1. Tap on the right of the Analog output adj. item.
The Analog output adj. screen is displayed.
Tap to return to the previous screen.

How to Analog Output Adj.



Connect the instrument with a digital multimeter, digital recorder, pen recorder or the like using a designated cable (analog output cable: Parts No.3014030152), and check and adjust the analog output value of the instrument.

1. Tap on the right of the analog output item.
The Output value adjustment screen is displayed.
2. Tap or to adjust the analog output voltage.
3. Tap .
To cancel the operation, tap to return to the previous screen.

2.15 Temperature Sensor Calibration



You can perform calibration of the temperature sensor.

1. Tap on the right of the Temp. calibration item.
The Temp. calibration setting screen is displayed.
To cancel the operation, tap to return to the previous screen.
2. Display the measured temperature by the temperature sensor connected to the instrument.
Display "-----", when not connecting the temperature sensor.
3. Tap on the right of the temperature sensor's channel item.
4. Enter the temperature with the numerical screen and tap .
Tap when do not reflect the setting.

2.16 Resetting to Factory Defaults

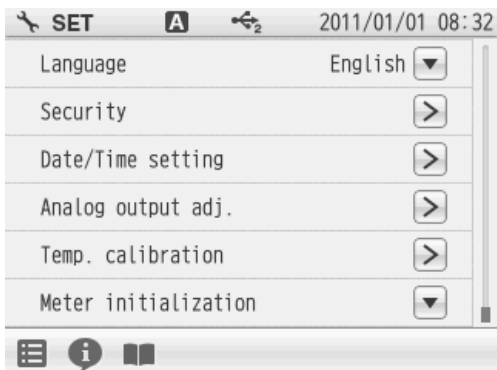

You can reset the instrument to the factory default conditions.

1. Tap on the right of the Meter initialization item.
2. Tap in the execution confirmation screen. Tap , when do not resetting.
3. Display the confirmation screen again, and tap . Tap , when do not resetting.
4. Restart after the Meter initialization was finished. Press the POWER key to turn OFF.
5. Press and hold the POWER key for 2 seconds to turn ON.

NOTE

If you disconnect the AC adapter after powering OFF, the POWER key does not work for 10 seconds after the AC adapter is reconnected. Wait for a while after reconnecting AC adapter.

Chapter 3 pH Measurement

3.1 pH Calibration Setting

This section describes the procedures to set the conditions of pH calibration.





1. Tap the channel setting and the measurement item in the MEAS screen to set "CH1" and "pH".
2. Press the CAL key to display the pH CAL screen.
3. Tap  and tap "CH1 CAL SET".
pH calibration setting items are displayed.
You will see the remaining items by dragging.
4. Select items and set the conditions.

The setting procedures for each item are explained below.

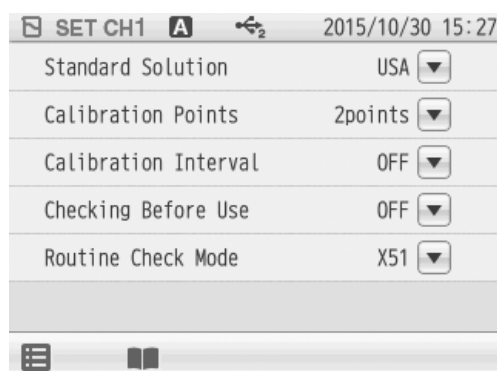
3.1.1 Standard Solution



Standard solutions of NIST, NIST2, USA, China and CUSTOM (other than above, or user's designated) can be used for pH calibration. USA is set as default.

1. Tap  on the right of the Standard Solution item, and tap the standard solution in the selection screen.
The setting applies. The check mark on the current setting item is displayed.
To cancel the settings, tap .

Buffer group	pH value at 25°C each buffer solution					
	pH2	pH4	pH7	pH9	pH10	pH12
Standard						
NIST	1.679	4.008	6.865	9.180	–	12.454
NIST2	1.679	4.008	6.865	–	10.011	12.454
USA	1.679	4.008	7.000	–	10.011	12.454
China	1.680	4.003	6.864	9.182	–	12.460

3.1.2 Calibration Points

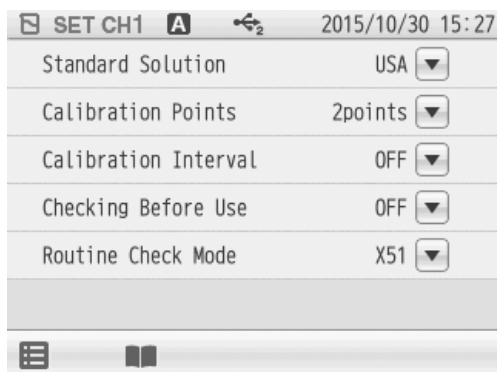

Up to 5 points calibration is possible.
Set the number of the calibration points.

1. Tap on the right of the Calibration Points item.
2. Tap or in the Calibration points setting screen to set the calibration points.
3. Tap .
The setting applies.

3.1.3 Calibration Interval

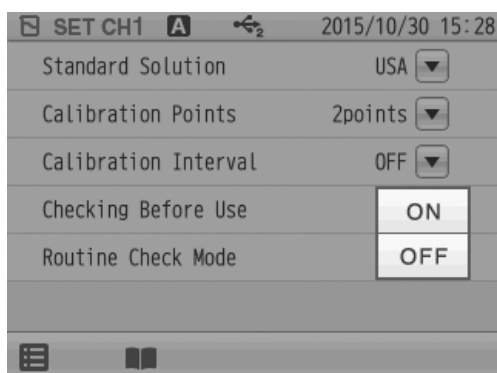

You can set the number of days between calibrations to the initiate an alert.

1. Tap on the right of the Calibration Interval item to set the calibration interval.
2. Tap .

Enter Calibration Interval

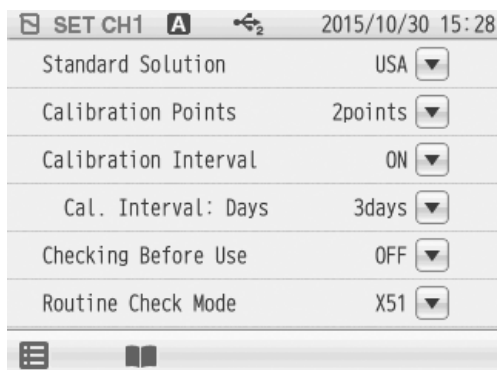

1. Display the Cal. Interval item when select ON at the calibration interval. Tap on the right of the Cal. Interval item.
2. Enter the interval day in the numerical-key screen.
3. Tap .
The setting applies.
To cancel the settings, tap .

HINT!

We recommend performing calibration once a day, before measurement.

3.1.4 Checking Before Use

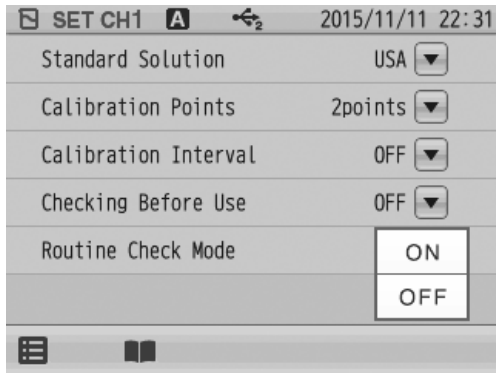

If you set the Checking Before Use setting to ON, it allows you to check repeatability after calibration by comparing the measured value of pH7 standard solution with the calibration result. After the set point calibrations are completed, repeatability is automatically checked using the deviation between the calibrated and measured values at pH7.

For example, the sequence for the 2 points calibration by pH7 and pH4 is as follows.

pH7 (Calibration of 1st point) --> pH4 (Calibration of 2nd point) --> pH7 (Repeatability check with the calibrated value by 1st point)

1. Tap on the right of the Checking Before Use item to set the preliminary checking.
2. Tap ON .

NOTE

This preliminary check function is possible only when the standard solution is set to NIST, NIST2, USA, or China.

When the standard solution is set to CUSTOM, this function cannot be performed.

3.2 pH Calibration



It is necessary to perform calibration before pH measurement.

We recommend performing calibration once a day, before measurement.

Set the conditions of resolution and temperature compensation before pH calibration according to "3.5 pH Measurement Setting" (P.44).

HINT!

How to select standard solutions used for calibration

- Perform 2 points calibration using pH7 and pH4 when you know that the sample is acidic; pH7 and pH9 when you know that the sample is alkaline.
 - Perform 3 points calibration using pH4, pH7, and pH9 when the sample is unknown.
 - For calibration other than that by 2 points, change the calibration point setting.
 - Tapping  on the pH CAL screen allows you to check the current calibration data.
To clear the calibration data, tap .
-

As an example, the procedures of 2 points calibration using pH4 and pH7 standard solutions are as follows.

3.2.1 Calibration Preparation



1. Tap the channel setting and the measurement item in the MEAS screen to set "CH1" and "pH".
2. Tap the CAL key to display the pH CAL screen.
3. Wash the pH electrode with pure water (ion exchange water), and wipe it off by filter paper or tissue paper.
4. Open the internal solution filler port of the pH electrode.
5. Immerse the pH electrode into a beaker of pH7 standard solution.

Calibration of the 1st point



1. Tap **START** to start calibration with the 1st point.

The measurement value is displayed, and the HOLD indicator blinks until the reading stabilizes.

To stop calibration tap **STOP** while the HOLD indicator blinks.

NOTE

The blinking interval of the HOLD indicator may not be constant depending on the reading stability level.

When the reading stabilizes, the value is held and the progress bar shows that the pH7 calibration is completed.

2. After the 1st point calibration is completed, tap **STOP** to proceed to the 2nd point calibration.

Calibration of the 2nd point

After the 1st point calibration is completed, perform the 2nd point calibration.



1. Wash the pH electrode with pure water (ion exchange water), and wipe it off by filter paper or tissue paper.

2. Immerse the pH electrode into a beaker of pH4 standard solution.

3. Tap **START** to start calibration with the 2nd point.

When calibration of the 2nd point is complete, the calibration result is displayed on the screen.

4. After checking the calibration result, tap **CLOSE** to return to the CAL screen.

5. To start pH measurement, press the MEAS key. To perform calibration again, start the above procedures from the beginning.

NOTE

- For calibration using multiple standard solutions, continuously perform from one solution to another. If returned to the MEAS screen once, you have to go back to the 1st point calibration.
- When an error occurs in calibration, the screen displays the error. Remove the cause and start the calibration from the beginning.

Calibration Result Indication

When the electrode sensitivity is still low after calibration, or when a malfunction occurs at the preliminary check, the following display appears on the screen.

Display	Sensitivity	Description
Good	90% to 105%	You can use it without any problem.
Electrode check	85% to 90%	Wash the electrode. If the sensitivity does not improve after recalibration, replace the electrode.
Electrode NG	85% or less than	This appears only for calibration data on the DATA screen. (Calibration with 85% or less sensitivity does not apply to measurement, but is recorded on the DATA screen.) Replace the electrode.

3.3 Checking Before Use

When the preliminary check function is ON, you can check repeatability with pH7 standard solution. Use this function to check measurement accuracy by checking repeatability. An operation guide is displayed after the 2nd point calibration is completed. Check the repeatability according to the operation guide.



1. When calibration for all of the points is completed, the repeatability is automatically checked.
2. This repeatability check confirms the deviation from the calibrated value by the standard solution of pH7.

For example, the sequence for the 2nd point calibration by pH7 and pH4 is as follows.

pH7 (Calibration of 1st point) --> pH4 (Calibration of 2nd point) --> pH7 (Repeatability check with the calibrated value by 1st point)

Screen display	Repeatability
OK(0)	Within ± 0.005 pH
OK(1)	Within ± 0.02 pH
OK(2)	Within ± 0.05 pH
ERROR	Over ± 0.05 pH

NOTE

This preliminary check function is possible only when the standard solution is set to NIST, NIST2, USA, or China.

When the standard solution is set to CUSTOM, this function cannot be performed.

3.4 Calibration for Custom Selection

When the standard solution for pH calibration is set to CUSTOM, you can use desired standard solutions.

Enter the pH values of the standard solutions in the following procedures and use them for calibration.

3.4.1 Calibration Preparation



1. Press the CAL key to display the pH CAL screen.
2. Wash the pH electrode with pure water (ion exchange water), and wipe it off by filter paper or tissue paper.
3. Open the internal solution filler port of the pH electrode.
4. Immerse the pH electrode into a beaker of pH7 standard solution.

Calibration of the 1st Point



1. Tap the pH value at the right of "Set:" to display the numerical-key screen.
2. Enter the pH value of the standard solution to be used for calibration, and tap **ENTER**. The entered pH value applies as the standard solution.
3. Tap **START** to start the calibration of the 1st point. When the 1st point calibration is completed, the HOLD indicator is lit up and the progress bar shows that the 1st point calibration is completed.
4. After the 1st point calibration is completed, tap **STOP** to proceed to the 2nd point calibration. Perform the 2 point and later point calibration in the same procedures as above.

3.5 pH Measurement Setting

This section describes the procedures to set the conditions of pH measurement.



1. Tap the channel setting and the measurement item in the MEAS screen to set "CH1" and "pH".
2. Tap  and tap "CH1 MEAS SET".
3. pH measurement setting items are displayed. You will see the remaining items by dragging.
4. Select items and set the conditions.

The setting procedures for each item are explained below.

3.6 Indicated Resolution of pH Measurement Values Setting

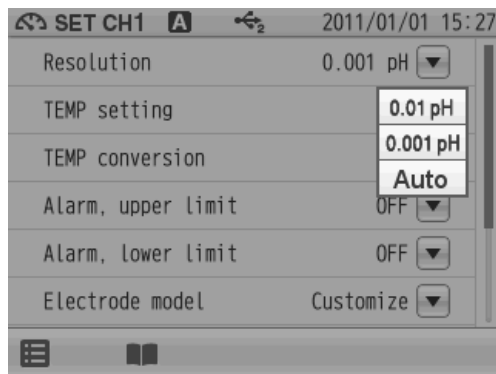

You can switch the resolution for pH measurement values to 0.01 pH, 0.001 pH, or Auto. If Auto is set, the resolution is switched automatically to 0.001 pH when the variation of pH measurement value is 0.01 pH or less in the latest 10 seconds, to 0.01 pH for the rest. This is a convenient function to judge the stability of pH measurement values.

3.7 Temperature Compensation Setting

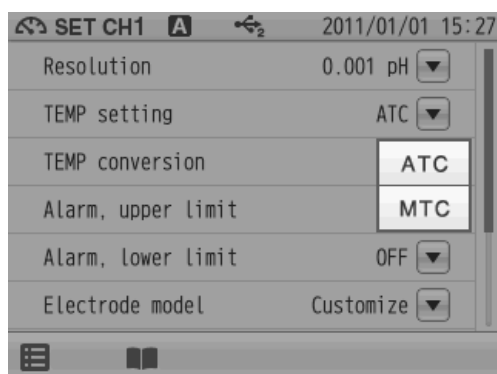

There are two types of temperature compensation for pH measurement; Automatic Temperature Compensation (ATC) and Manual Temperature Compensation (MTC).

In ATC, the instrument detects the solution temperature with the connected temperature sensor, and performs temperature compensation for the pH values of the standard solutions used for calibration.

In MTC, measure the solution temperature and enter the value in advance. The instrument performs temperature compensation using the entered temperature.

NOTE

If the temperature terminals of the instruction and electrode are not connected, temperature compensation is performed in MTC even when ATC is set.

3.7.1 Solution Temperature Entry in MTC (Manual Temperature Compensation)

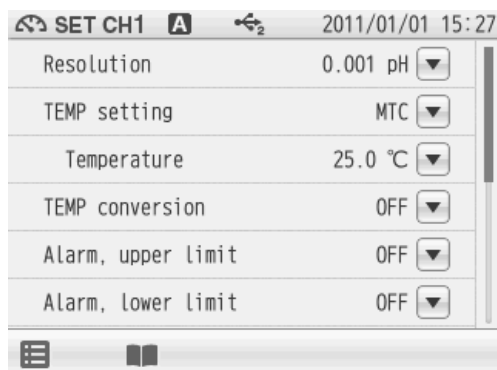

1. When selecting MTC for the TEMP setting item, the Temperature item is displayed.
Tap on the right of the Temperature item.
2. Enter the sample temperature on the numerical-key screen.
3. Tap ENTER .
The setting applies.
To cancel the settings, tap X .

3.8 Temperature Conversion Function Setting

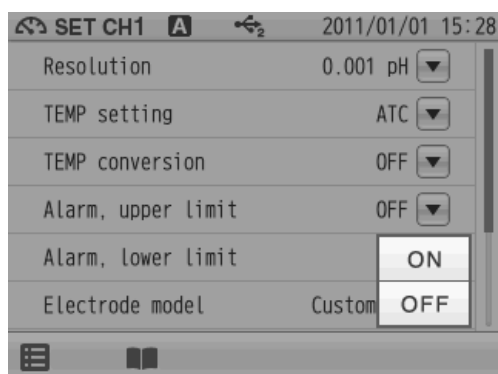

To use the temperature conversion function, set TEMP conversion to ON.



The measured pH value of a sample varies with the temperature. In addition, the change degree with temperature depends on the sample property.

If the change degree (temperature coefficient) of the sample is known, set this item to ON to display pH values converted at a set temperature. If the temperature coefficient is unknown, set this item to OFF.

3.8.1 Temperature Coefficient Setting

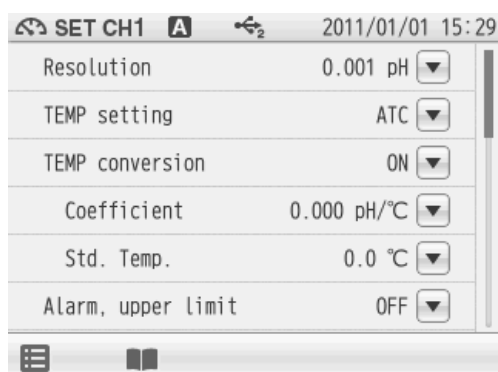

Coefficient entry

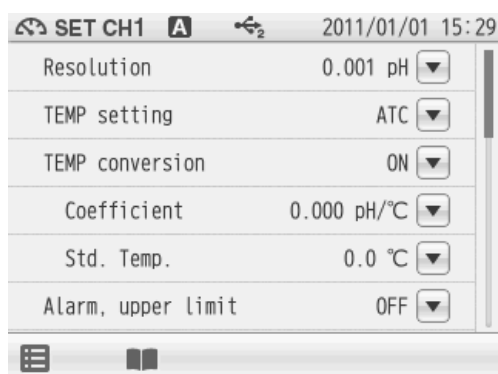

1. When selecting ON for the TEMP conversion item, the Coefficient item is displayed.
Tap  on the right of the Coefficient item.
2. Enter a coefficient (as pH variation per 1°C) on the numerical-key screen.
3. Tap .
The setting applies.
To cancel the settings, tap .

Std. Temp. entry



1. When selecting ON for the TEMP conversion item, the Std. Temp. item is displayed.
Tap  on the right of the Std. Temp. item.
2. Enter a temperature (as the standard temperature for conversion) on the numerical-key screen.
3. Tap .
The setting applies.
To cancel the settings, tap .

3.9 Alarm Setting

When the measurement values exceed the set upper or lower limit, the instrument detects it to display the notice on the screen or to output the signal from the external output terminal.

If the measurement values exceed the alarm range, the color of the pertinent channel "CH" is changes on the MEAS screen.

Set the upper limit alarm to ON for the upper limit control of measurement value.

Set the lower limit alarm to ON for the lower limit control of measurement value.

Upper limit value

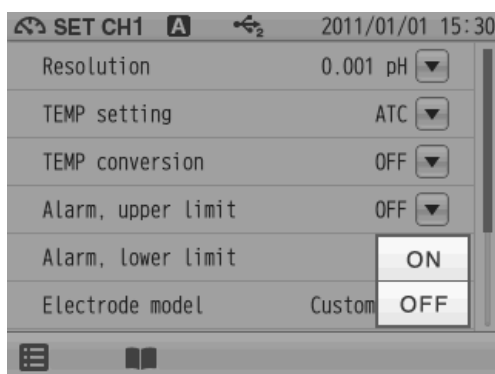

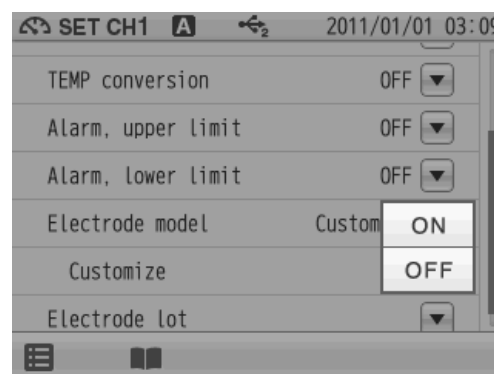

Lower limit value



3.9.1 Input Alarm, Upper Limit or Lower Limit



Upper limit value entry

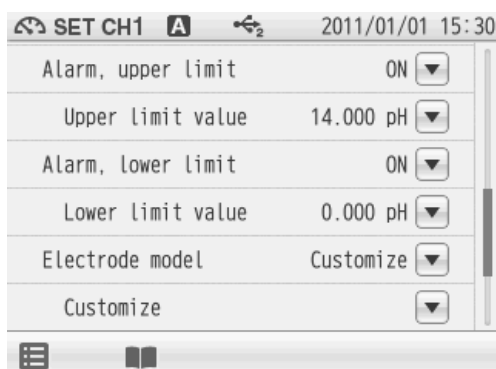

1. When selecting ON the Alarm, upper limit item, the Upper limit value, tap  on the right of the Upper limit value item.
2. Enter an upper limit value on the numerical-key screen.
3. Tap  .
The setting applies.
To cancel the settings, tap  .

Lower Limit value entry



1. When selecting ON the Alarm, lower limit item, the Lower limit value, tap  on the right of the Lower limit value item.
2. Enter a lower limit value on the numerical-key screen.
3. Tap  .
The setting applies.
To cancel the settings, tap  .

3.10 Electrode Model Setting

When an electrode model is set, the model name can be displayed on data printouts or recorded in saved data.

Select the electrode model to be used for measurement.

You can set a desired name with up to 10 characters by selecting the Customize item.

3.10.1 Electrode Model Selection

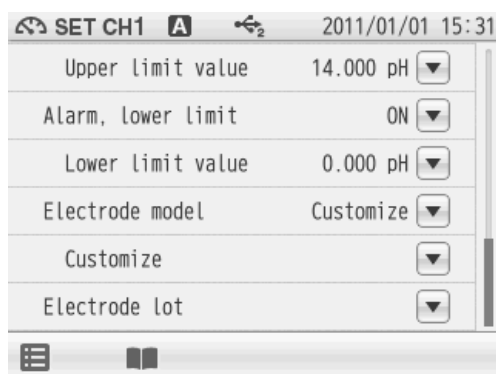

1. Tap on the right of the Electrode model item. The electrode model selection screen appears. Tap when do not reflect the setting.
2. Select the electrode model to be used. Tap an electrode model name, and the selected model applies.

3.10.2 Electrode Model Entry



You can set a desired name with up to 10 characters.

1. Tap "Customize" in the electrode model selection screen.
2. When selecting Customize for the Electrode model item, the Customize item is displayed. Tap on the right of the Customize item.
3. Enter an electrode model name using the keyboard screen. Tap to switch the keyboard entry screen of Alphabet --> Numerical/Symbol. Tap to input in lower-case alphabets. Up to 10 characters can be input.
4. Tap . The setting applies. To cancel the settings, tap .

HINT!

To delete a registered electrode model name, tap on the right of the electrode model name, enter nothing, and tap .

3.11 Electrode Lot No. Setting

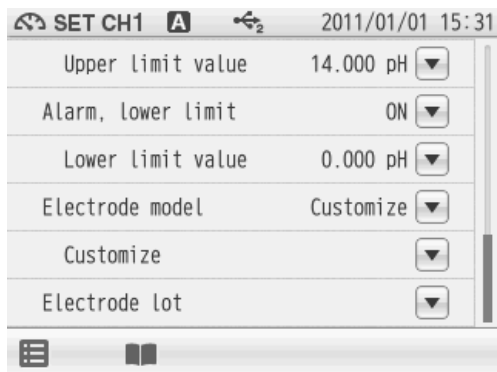

When an electrode lot No. is entered, the lot No. can be displayed on data printouts or recorded in saved data.

1. Tap on the right of the Electrode lot item.
2. Enter the electrode lot No. in the numerical screen.
Up to 8 digits can be entered.
To cancel the settings, tap .

HINT!

To delete a registered electrode lot No., tap on the right of the electrode lot No., enter nothing, and tap .

3.12 pH Measurement

This section describes the procedures of pH measurement.





Tapping  allows you to check the information of the current calibration (operator, calibration date, calibration points).



1. Wash the electrode with pure water (ion exchange water), and wipe it off either with filter paper or tissue paper.
2. Open the internal solution filler port of the electrode.
During measurement, the filler port should be kept open.

NOTE

The filler port configuration depends on the electrode type.

3. Immerse the electrode into the sample solution deeper than 3 cm from the tip.
Immerse the electrode tip at least 3 cm into the sample solution for an accurate measurement. Refer to the instruction manual of the electrode for more details.
4. Press the MEAS key, and tap the channel setting and the measurement item in the MEAS screen to set "CH1" and "pH".
5. Tap  to start measurement.
The measurement value is displayed, and the HOLD indicator blinks until the reading stabilizes.
To stop calibration tap  while the HOLD indicator blinks.
When the reading stabilizes, the value is held and HOLD indicator lights up.
During instantaneous value measurement, or when a measurement value is held, you can store the measurement values by tapping  on the bottom of the screen.
6. After the measurement is completed, tap  to proceed to the next measurement.

Chapter 4 ION Measurement

4.1 ION Calibration Setting

This section describes the procedures to set the conditions of ION calibration.





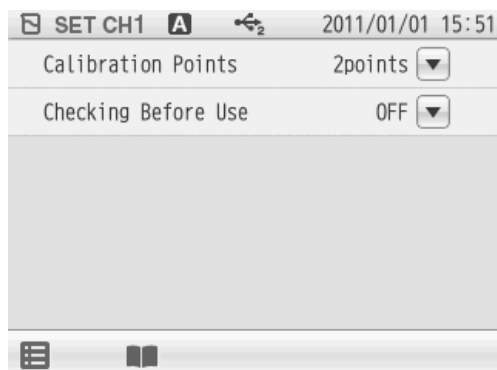

1. Tap the channel setting and the measurement item in the MEAS screen to set "CH1" and "ION".
2. Press the CAL key to display the ION CAL screen.
3. Tap  and tap "CH1 CAL SET".
Ion calibration setting items are displayed.
4. Select items and set the CONDITIONS.

The setting procedures for each item are explained below.

4.1.1 Calibration Points Setting



Up to 5 points calibration is possible.
Set the number of the calibration points.

1. Tap  on the right of the Calibration Points item.
2. Tap  or  in the Calibration points setting screen to set the calibration points.
3. Tap .
The setting applies.
To cancel the settings, tap .

4.1.2 Checking Before Use

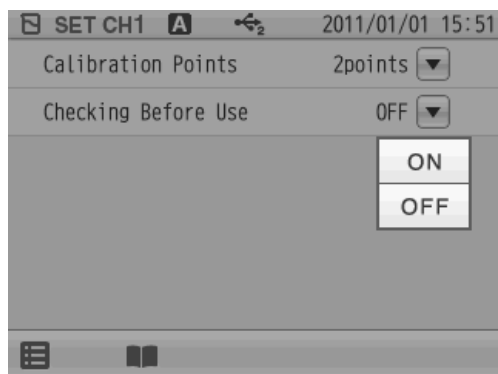

If you set the Checking Before Use setting to ON, it allows you to check repeatability after calibration by comparing the measured value of first point calibration standard solution with the calibration result.

After the set point calibrations are completed, repeatability is automatically checked using the deviation between the calibrated and measured values at first point calibration.

For example, the sequence for the 2 points calibration is as follows.

Calibration of 1st point --> Calibration of 2nd point --> Repeatability check with the calibrated value by 1st point

1. Tap on the right of the Checking Before Use item to set the preliminary checking.
2. Tap ON .

4.2 ION Calibration

There are two methods to measure ion concentrations using an ion electrode; the calibration curve method and the standard addition method.

In the calibration curve method, you prepare a calibration curve showing the relation between mV and concentration using some standard solutions of different concentrations and use it to measure ion concentration of a sample.

We recommend performing calibration once a day, before measurement.

Refer to the instruction manual of the ion electrode for standard solution preparation.

Perform resolution temperature setting before ION calibration according to the paragraph of "4.4 ION Measurement Setting" (P.56).

NOTE

- The calibration calculation of an ION electrode depends on the unit and ion to be measured. Perform ION measurement setting before starting calibration.
 - Tapping ⓘ on the ION CAL screen allows you to check the current calibration data. To clear the calibration data, tap 🗑️.
-

As an example, the procedures of 2 points calibration using standard solutions are as follows.

4.2.1 Calibration Preparation



1. Tap the channel setting and the measurement item in the MEAS screen to set "CH1" and "ION".
2. Press the CAL key to display the ION CAL screen.
3. Wash the ION electrode with pure water (ion exchange water), and wipe it off by filter paper or tissue paper.
4. Open the internal solution filler port of the ION electrode.
5. Immerse the ION electrode into a beaker of the standard solution used for the 1st point calibration.

Calibration of the 1st point



1. Tap the ION value at the right of "Set:" to display the numerical-key screen.
2. Enter the ION concentration value of the standard solution to be used for calibration.
3. Tap **ENTER**.
The concentration of standard solution to calibrate is reflected.
4. Tap **START** to start the calibration of the 1st point.
When the 1st point calibration is completed, the HOLD indicator is lit up and the progress bar shows that the 1st point calibration is completed.

Calibration of the 2nd point

After the 1st point calibration is completed, tap **STOP** to proceed to the 2nd point calibration.



1. Wash the ION electrode with pure water (ion exchange water), and wipe it off by filter paper or tissue paper.
2. Immerse the ION electrode into a beaker of the standard solution used for the 2nd point calibration.
The procedures of subsequent calibration are same as 1st point calibration.
3. Tap **START** to start the calibration of the 2nd point.
When calibration of the 2nd point is complete, the calibration result is displayed on the screen.
4. Tap **CLOSE** after checking the calibration result to return to the CAL screen.
5. To start ION measurement, press the MEAS key.
To perform calibration again, start the above procedures from the beginning.

NOTE

- For calibration using multiple standard solutions, continuously perform from one solution to another. If returned to the MEAS screen once, you have to go back to the 1st point calibration.
- When an error occurs in calibration, the screen displays the error. Remove the cause and start the calibration from the beginning.

4.3 Checking Before Use

When the preliminary check function is ON, you can check repeatability with the standard solution of the 1st point calibration. Use this function to check measurement accuracy by checking repeatability.

An operation guide is displayed after the 2nd point calibration is completed. Check the repeatability according to the operation guide.



After the set point calibrations are completed, repeatability is automatically checked using the deviation between the calibrated and measured values at the 1st point.

4.4 ION Measurement Setting

This section describes the procedures to set the conditions of ION measurement.



1. Tap the channel setting and the measurement item in the MEAS screen to set "CH1" and "ION".
2. Tap  and tap "CH1 MEAS SET".
3. ION measurement setting items are displayed. You will see the remaining items by dragging.
4. Select items and set the CONDITIONS.

The setting procedures for each item are explained below.

4.5 ION Measurement Unit Setting

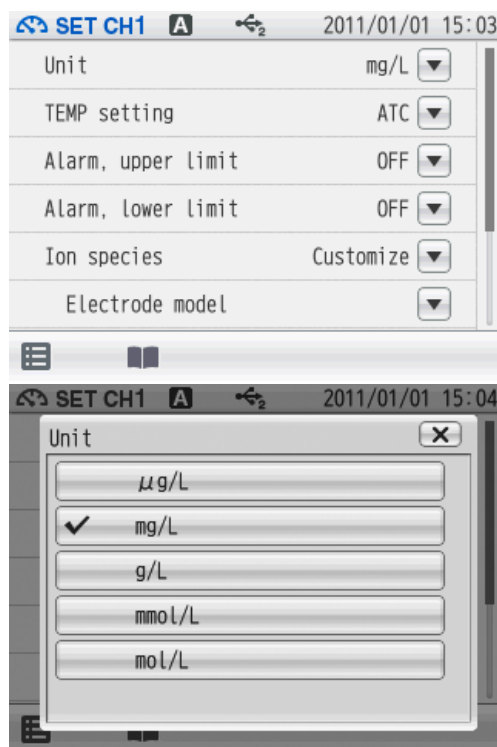

You can select $\mu\text{g/L}$, mg/L, g/L, mmol/L or mol/L as the ION measurement unit.

1. Tap  on the right of the Unit item.
2. Select the unit to set.
The selected unit applies.

4.6 Temperature Compensation Setting

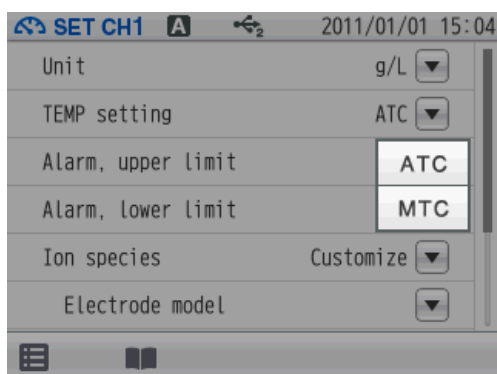

There are two types of temperature compensation for ION measurement; Automatic Temperature Compensation (ATC) and Manual Temperature Compensation (MTC).

In ATC, the instrument detects the solution temperature with the connected temperature sensor, and performs temperature compensation for the ION values of the standard solutions used for calibration.

In MTC, measure the solution temperature and enter the value in advance. The instrument performs temperature compensation using the entered temperature.

NOTE

If the temperature terminals of the instruction and electrode are not connected, temperature setting is performed in MTC even when ATC is set.

4.6.1 Solution Temperature Entry in MTC (Manual Temperature Compensation)

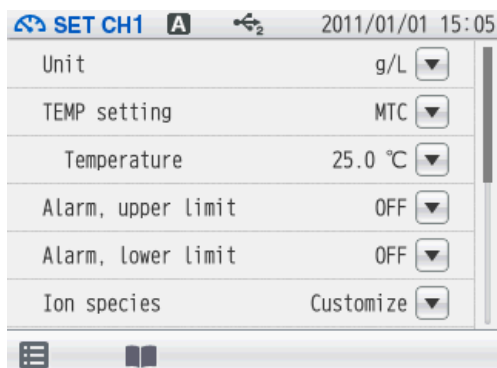

1. When selecting MTC for the TEMP setting item, the Temperature item is displayed.
Tap on the right of the Temperature item.
2. Enter the sample temperature on the numerical-key screen.
3. Tap .
The setting applies.
To cancel the settings, tap .

4.7 Alarm Setting

When the measurement values exceed the set upper or lower limit, the instrument detects it to display the notice on the screen or to output the signal from the external output terminal.

If the measurement values exceed the alarm range, the color of the pertinent channel "CH" is changes on the MEAS screen.

Set the upper limit alarm to ON for the upper limit control of measurement value.

Set the lower limit alarm to ON for the lower limit control of measurement value.

Upper limit value

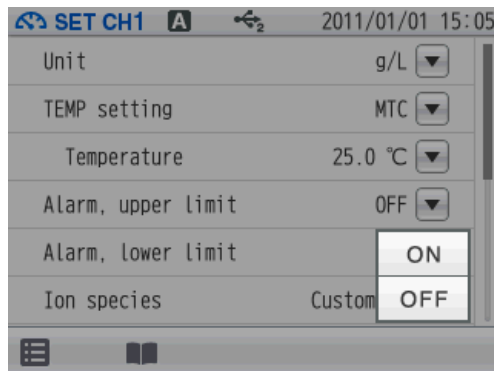

Lower limit value

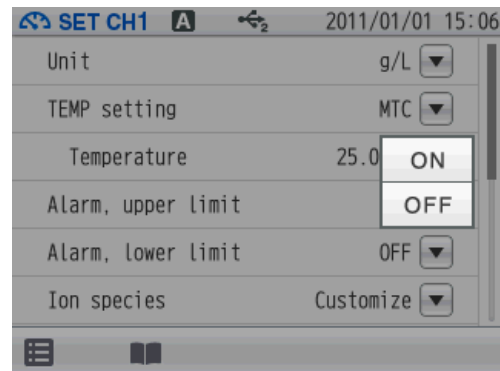

4.7.1 Input Upper or Lower Limit Values

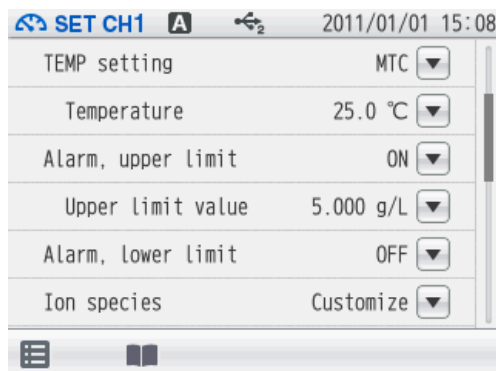

Upper limit value entry



1. When selecting ON the Alarm, upper limit item, the Upper limit value, tap on the right of the Upper limit value item.
2. Enter an upper limit value on the numerical-key screen.
To change the unit (mg/L, μ g/L, etc.), tap on the unit change key on the right of the numerical-key screen.
3. Tap .
The setting applies.
To cancel the settings, tap .

Lower Limit value entry

TEMP setting	MTC
Temperature	25.0 °C
Alarm, upper limit	ON
Upper limit value	5.000 g/L
Alarm, lower limit	ON
Lower limit value	0.000 g/L

1. When selecting ON the Alarm, lower limit item, the Lower limit value, tap  on the right of the Lower limit value item.
2. Enter an upper limit value on the numerical-key screen.
To change the unit (mg/L, µg/L, etc.), tap on the unit change key on the right of the numerical-key screen.
3. Tap  .
The setting applies.
To cancel the settings, tap  .

NOTE

Even when unit or ion type is changed, the alarm set value will not change.

4.8 Electrode Model Setting

This section describes the procedures to set the ion species or ion valency to be measured. Select the ion species or ion valency to be measured.

4.8.1 Ion species Selection

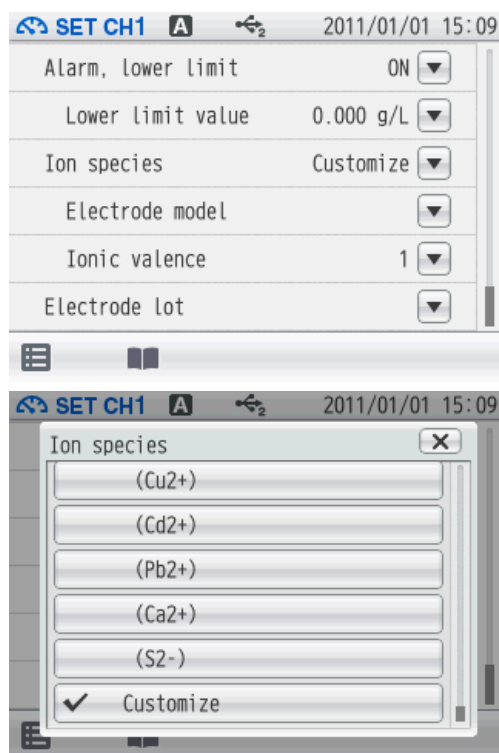

1. Tap on the right of the Ion species item. The ion species selection screen appears. Tap when do not reflect the setting.
2. Select the ion species to be measured. Tap ion species, and the selected ion species applies.

4.8.2 Electrode Model Entry



You can set a desired electrode model name with up to 10 characters.

1. Tap on the right of the Electrode model item.
2. Enter an electrode model name using the keyboard screen. Tap to switch the keyboard entry screen of Alphabet --> Numerical/Symbol. Tap to input in and lower-case alphabets. Up to 10 characters can be input.
3. Tap . The setting applies. To cancel the settings, tap .

HINT!

To delete a registered electrode model name, tap on the right of the electrode model name, enter nothing, and tap .

4.8.3 ION Valency Setting

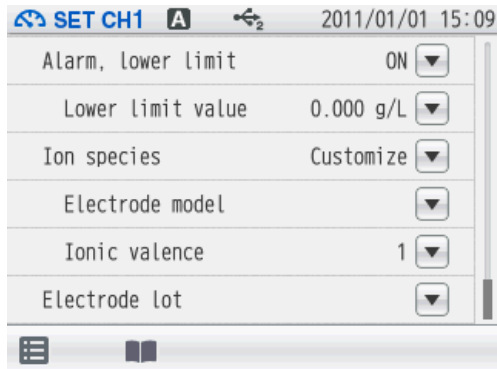

When the Ion species item is set to Customize, enter the valency of the ion to be measured.

1. Tap on the right of the ionic valence item.
2. Tap or in the ionic valence setting screen to set the ION valency.
3. Tap .
The setting applies.
To cancel the settings, tap .

4.9 Electrode Lot No. Setting

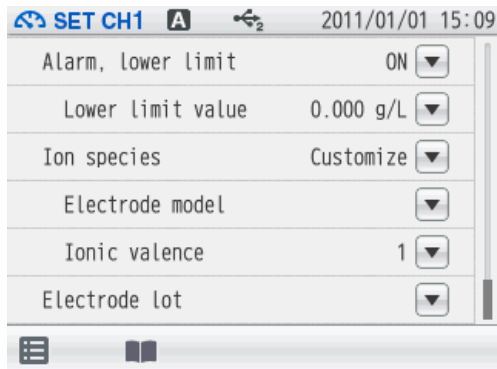

When an electrode lot No. is entered, the lot No. can be displayed on data printouts or recorded in saved data.

1. Tap on the right of the Electrode lot item.
2. Enter the electrode lot No. in the numerical-key screen.
Up to 8 digits can be entered.
To cancel the settings, tap .

HINT!

To delete a registered electrode lot No., tap on the right of the electrode lot No., enter nothing, and tap .

4.10 ION Measurement

This section describes the procedures of ION measurement.



1. Wash the electrode with pure water (ion exchange water), and wipe it off either with filter paper or tissue paper.
2. Open the internal solution filler port of the electrode.
During measurement, the filler port should be kept open.

NOTE

The filler port configuration depends on the electrode type.

3. Immerse the electrode into the sample solution deeper than 3 cm from the tip.
Immerse the electrode tip at least 3 cm into the sample solution for an accurate measurement. Refer to the instruction manual of the electrode for more details.
4. Press the MEAS key, and tap the channel setting and the measurement item in the MEAS screen to set "CH1" and "ION".
5. Tap **START** to start 1st point measurement.
The measurement value is displayed, and the HOLD indicator blinks until the reading stabilizes.
To stop calibration tap **STOP** while the HOLD indicator blinks.
When the reading stabilizes, the value is held and HOLD indicator lights up.
During instantaneous value measurement, or when a measurement value is held, you can store the measurement values by tapping  on the bottom of the screen.
6. After the measurement is completed, tap **STOP** to proceed to the next measurement.

Chapter 5 mV Measurement

This section describes the procedures to set the conditions of mV measurement.

5.1 mV Measurement Setting

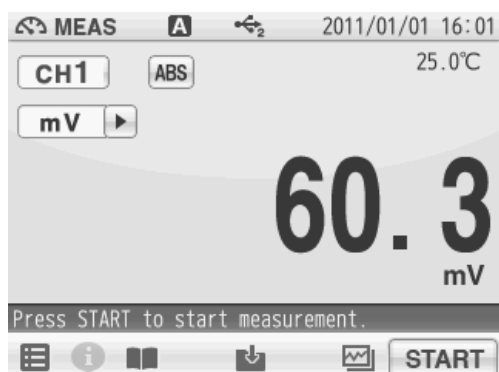

1. Tap the channel setting and the measurement item in the MEAS screen to set "CH1" and "mV".
2. Tap  and tap "CH1 MEAS SET".
3. mV measurement setting items are displayed. When setting item increased, you will see the remaining items by dragging.
4. Select items and set the conditions.

The setting procedures for each item are explained below.

5.2 Temperature Setting

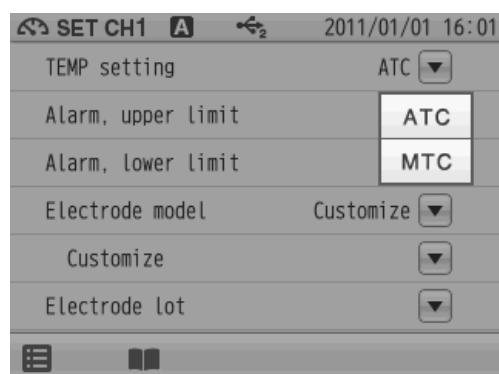

There are two types of temperature setting for mV measurement; Automatic Temperature setting (ATC) and Manual Temperature setting (MTC). In ATC, the instrument detects the solution temperature with the connected temperature sensor, and displays it on the screen. In MTC, measure the solution temperature and enter the value in advance. The instrument displays the entered temperature.

NOTE

If the temperature terminals of the instruction and electrode are not connected, temperature setting is performed in MTC even when ATC is set.

5.2.1 Solution Temperature Entry in MTC (Manual Temperature Setting)

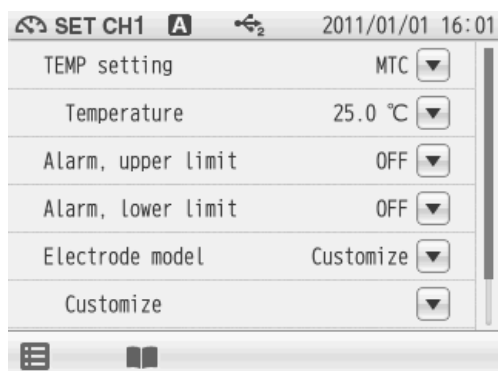

1. Display the Temperature item when select MTC.
Tap on the right of the Temperature item.
2. Enter the solution temperature on the numerical-key screen.
3. Tap .
The setting applies.
To cancel the settings, tap .

5.3 Alarm Setting

When the measurement values exceed the set upper or lower limit, the instrument detects it to display the notice on the screen or to output the signal from the external output terminal.

If the measurement values exceed the alarm range, the color of the pertinent channel "CH" is changes on the MEAS screen.

Set the upper limit alarm to ON for the upper limit control of measurement value.

Set the lower limit alarm to ON for the lower limit control of measurement value.

Upper limit value

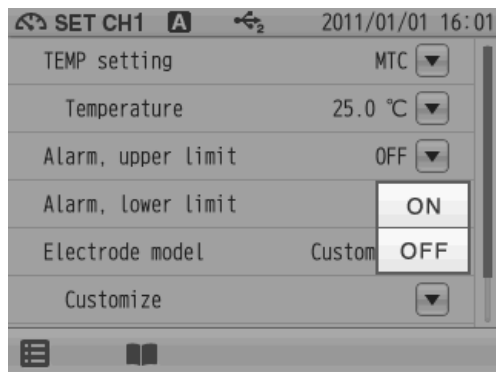

Lower limit value

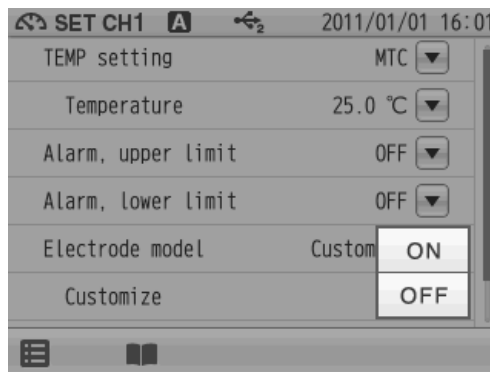

5.3.1 Input Upper or Lower Limit Values

Upper limit value entry

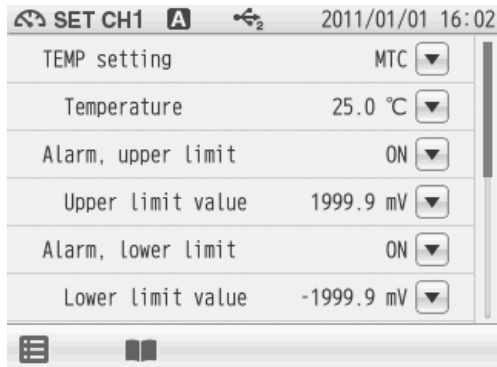

1. When selecting ON the Alarm, upper limit item, the Upper limit value, tap ▼ on the right of the Upper limit value item.
2. Enter an upper limit value on the numerical-key screen.
3. Tap ENTER .
The setting applies.
To cancel the settings, tap ✕ .

Lower limit value entry

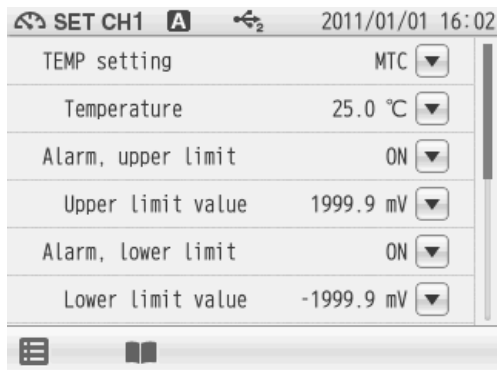

1. When selecting ON the Alarm, lower limit item, the Lower limit value, tap ▼ on the right of the Lower limit value item.
2. Enter an upper limit value on the numerical-key screen.
3. Tap ENTER .
The setting applies.
To cancel the settings, tap ✕ .

5.4 Electrode Model Setting

When an electrode model is set, the model name can be displayed on data printouts or recorded in saved data.

Select the electrode model to be used for measurement.

You can set a desired name with up to 10 characters by selecting the Customize item.

5.4.1 Electrode Model Selection

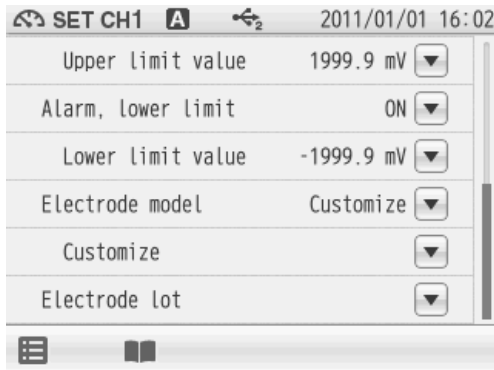

1. Tap on the right of the Electrode model item. The electrode model selection screen appears. Tap when do not reflect the setting.
2. Select the electrode model to be use. Tap an electrode model name, and the selected model applies.

5.4.2 Electrode Model Entry

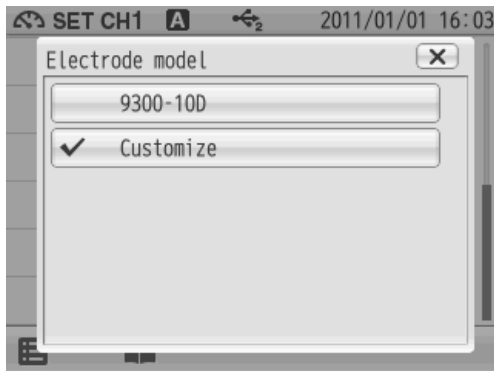

You can set a desired name with up to 10 characters.

1. Tap "Customize" in the electrode model selection screen.
2. When selecting Customize for the Electrode model item, the Customize item is displayed. Tap on the right of the Customize item.
3. Enter an electrode model name using the keyboard screen. Tap to switch the keyboard entry screen of Alphabet --> Numerical/Symbol. Tap to input in and lower-case alphabets. Up to 10 characters can be input.
4. Tap . The setting applies. To cancel the settings, tap .

HINT!

To delete a registered electrode model name, tap on the right of the electrode model name, enter nothing, and tap .

5.5 Electrode Lot No. Setting

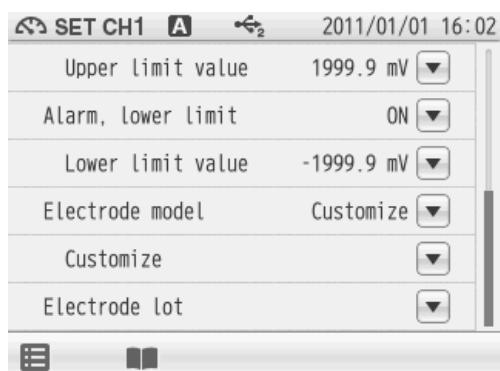

When an electrode lot No. is entered, the lot No. can be displayed on data printouts or recorded in saved data.

1. Tap ▼ on the right of the Electrode lot item.
2. Enter the electrode lot No. in the numerical-key screen.
Up to 8 digits can be entered.
To cancel the settings, tap ✕.

HINT!

To delete a registered electrode lot No., tap ▼ on the right of the electrode lot No., enter nothing, and tap **ENTER**.

5.6 mV Measurement

This section describes the procedures of mV measurement.

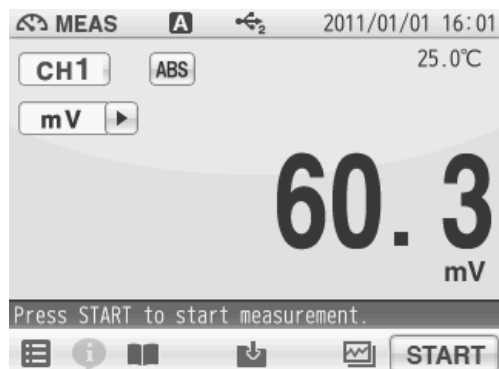

1. Wash the electrode with pure water (ion exchange water), and wipe it off either with filter paper or tissue paper.
2. Open the internal solution filler port of the electrode.
During measurement, the filler port should be kept open.

NOTE

The filler port configuration depends on the electrode type.

3. Immerse the electrode into the sample solution deeper than 3 cm from the tip.
Immerse the electrode tip at least 3 cm into the sample solution for an accurate measurement. Refer to the instruction manual of the electrode for more details.
4. Press the MEAS key, and tap the channel setting and the measurement item in the MEAS screen to set "CH1" and "mV".
Tap **ABS** to convert the potential display between ABS (absolute potential) and REL (relative potential).
Tapping **ABS** shifts the measured potential to zero, and displays the difference in relative potential.
The potential without correction is called "absolute potential."
5. Tap **START** to start measurement.
The measurement value is displayed, and the HOLD indicator blinks until the reading stabilizes.
To stop calibration tap **STOP** while the HOLD indicator blinks.
When the reading stabilizes, the value is held and HOLD indicator lights up.
During instantaneous value measurement, or when a measurement value is held, you can store the measurement values by tapping  on the bottom of the screen.
6. After the measurement is completed, tap **STOP** to proceed to the next measurement.



Chapter 6 ORP Measurement

6.1 ORP Calibration

This section describes the procedures to set the conditions of ORP calibration.

ORP measurement uses platinum or gold-plated metal electrodes. You can correct gaps between measured values and nominal values of the standard solutions, which resulting from shifts of the comparison electrode or contamination on the metal surface of the electrode.

HINT!

Tapping  on the ORP CAL screen allows you to check the current calibration data. To clear the calibration data, tap .

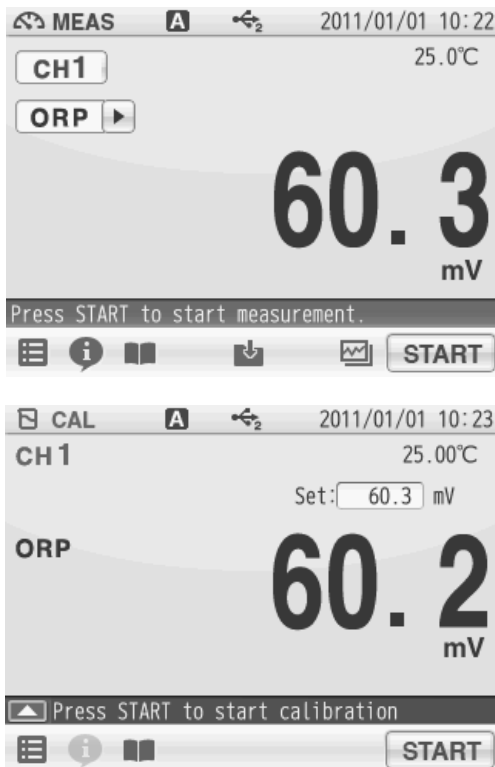

1. Tap the channel setting and the measurement item in the MEAS screen to set "CH1" and "ORP".
2. Press the CAL key to display the ORP CAL screen.
3. Wash the ORP electrode with pure water (ion exchange water), and wipe it off by filter paper or tissue paper.
4. Open the internal solution filler port of the ORP electrode.
5. Immerse the ORP electrode into a beaker of the standard solution.
6. Tap the mV value at the right of "Set:" to display the numerical-key screen.
7. Enter the mV value of standard solution to calibrate, and tap **ENTER**.
The concentration of standard solution to calibrate is reflected.
8. Tap **START** to start the calibration.
9. When the calibration is completed, the HOLD indicator is lit, displaying the calibration result.
10. Tap **CLOSE** after checking the calibration result to return to the CAL screen.
11. To start ORP measurement, press the MEAS key.

6.2 ORP Measurement Setting

This section describes the procedures to set the conditions of ORP measurement.

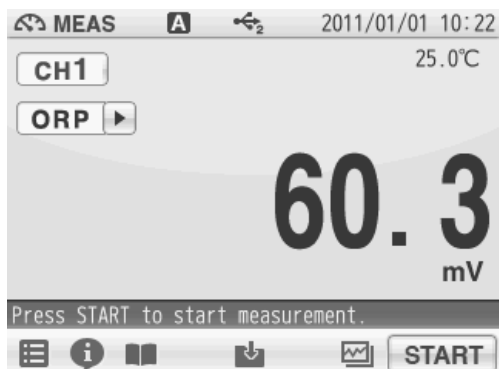

1. Tap the channel setting and the measurement item in the MEAS screen to set "CH1" and "ORP".
2. Tap  and tap "CH1 MEAS SET".
3. ORP measurement setting items are displayed. When setting item increased, you will see the remaining items by dragging.
4. Select items and set the conditions.

The setting procedures for each item are explained below.

6.3 Temperature Setting

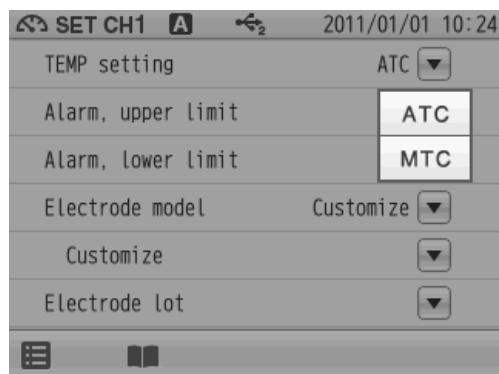

There are two types of temperature setting for ORP measurement; Automatic Temperature setting (ATC) and Manual Temperature setting (MTC).

In ATC, the instrument detects the solution temperature with the connected temperature sensor, and displays it on the screen.



In MTC, measure the solution temperature and enter the value in advance. The instrument displays the entered temperature.

NOTE

If the temperature terminals of the instruction and electrode are not connected, temperature setting is performed in MTC even when ATC is set.

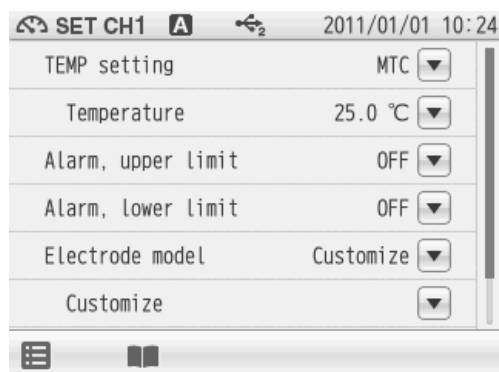
6.3.1 Solution Temperature Entry in MTC (Manual Temperature Setting)



1. Display the Temperature item when select MTC. Tap  on the right of the Temperature item.
2. Enter the solution temperature on the numerical-key screen.
3. Tap . The setting applies. To cancel the settings, tap .

6.4 Alarm Setting

When the measurement values exceed the set upper or lower limit, the instrument detects it to display the notice on the screen or to output the signal from the external output terminal.

If the measurement values exceed the alarm range, the color of the pertinent channel "CH" is changes on the MEAS screen.

Set the upper limit alarm to ON for the upper limit control of measurement value.

Set the lower limit alarm to ON for the lower limit control of measurement value.

Upper limit value

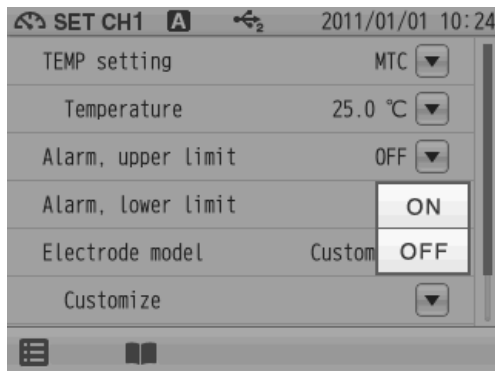

Lower limit value

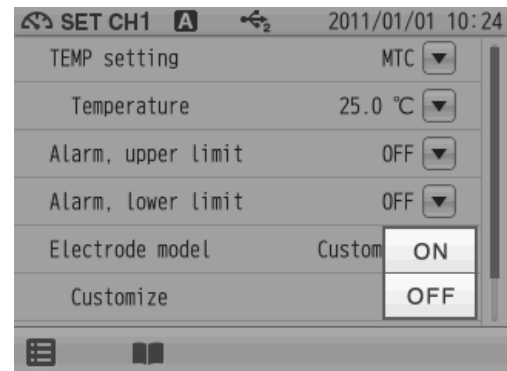

6.4.1 Input Upper or Lower Limit Values

Upper limit value entry

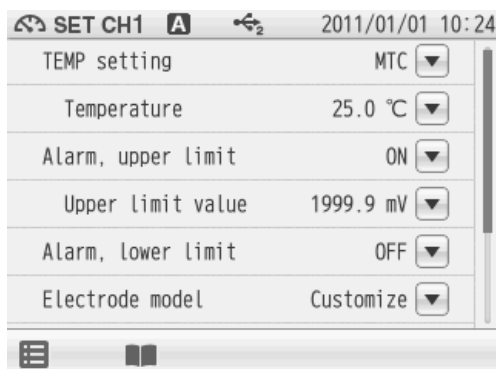

1. When selecting ON the Alarm, upper limit item, the Upper limit value, tap on the right of the Upper limit value item.
2. Enter an upper limit value on the numerical-key screen.
3. Tap .
The setting applies.
To cancel the settings, tap .

Lower limit value entry



1. When selecting ON the Alarm, lower limit item, the Lower limit value, tap on the right of the Lower limit value item.
2. Enter an upper limit value on the numerical-key screen.
3. Tap .
The setting applies.
To cancel the settings, tap .

6.5 Electrode Model Setting

When an electrode model is set, the model name can be displayed on data printouts or recorded in saved data.

Select the electrode model to be used for measurement.

You can set a desired name with up to 10 characters by selecting the Customize item.

6.5.1 Electrode Model Selection



1. Tap on the right of the Electrode model item. The electrode model selection screen appears. Tap when do not reflect the setting.
2. Select the electrode model to be use. Tap an electrode model name, and the selected model applies.

6.5.2 Electrode Model Entry

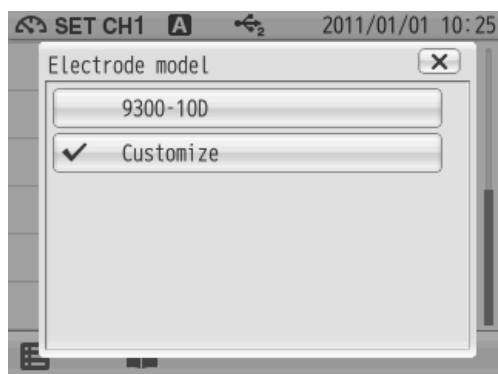

You can set a desired name with up to 10 characters.

1. Tap "Customize" in the electrode model selection screen.
2. When selecting Customize for the Electrode model item, the Customize item is displayed. Tap on the right of the Customize item.
3. Enter an electrode model name using the keyboard screen. Tap to switch the keyboard entry screen of Alphabet --> Numerical/Symbol. Tap to input in and lower-case alphabets. Up to 10 characters can be input.
4. Tap . The setting applies. To cancel the settings, tap .

HINT!

To delete a registered electrode model name, tap on the right of the electrode model name, enter nothing, and tap .

6.6 Electrode Lot No. Setting

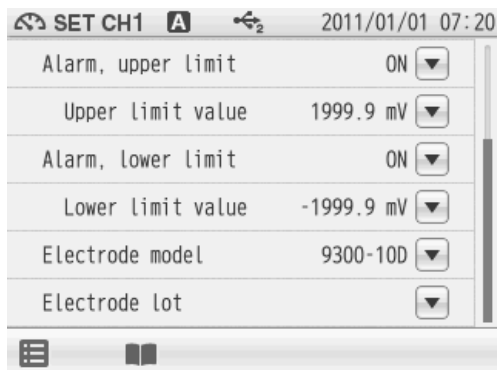

When an electrode lot No. is entered, the lot No. can be displayed on data printouts or recorded in saved data.

1. Tap on the right of the Electrode lot item.
2. Enter the electrode lot No. on the numerical-key screen.
Up to 8 digits can be entered.
To cancel the settings, tap .

HINT!

To delete a registered electrode model name, tap on the right of the electrode model name, enter nothing, and tap .

6.7 ORP Measurement

This section describes the procedures of ORP measurement.

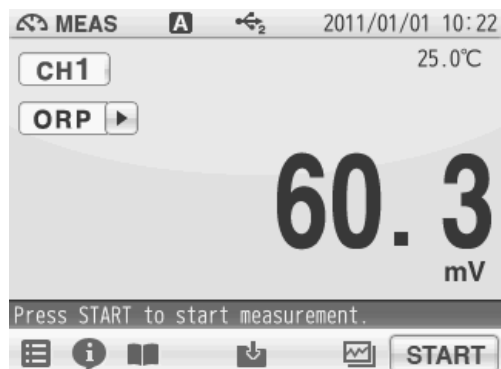

1. Wash the electrode with pure water (ion exchange water), and wipe it off either with filter paper or tissue paper.
2. Open the internal solution filler port of the electrode.
During measurement, the filler port should be kept open.

NOTE

The filler port configuration depends on the electrode type.

3. Immerse the electrode into the sample solution deeper than 3 cm from the tip.
Immerse the electrode tip at least 3 cm into the sample solution for an accurate measurement. Refer to the instruction manual of the electrode for more details.
4. Press the MEAS key, and tap the channel setting and the measurement item in the MEAS screen to set "CH1" and "ORP".
5. Tap **START** to start measurement.
The measurement value is displayed, and the HOLD indicator blinks until the reading stabilizes.
To stop calibration tap **STOP** while the HOLD indicator blinks.
When the reading stabilizes, the value is held and HOLD indicator lights up.
During instantaneous value measurement, or when a measurement value is held, you can store the measurement values by tapping  on the bottom of the screen.
6. After the measurement is completed, tap **STOP** to proceed to the next measurement.

Chapter 7 Application Mode

The application mode enables the measurement for the ION standard addition method and the pharmaceutical water inspection methods under various Pharmacopeias by conductivity measurement in conformance to specific measurement methods. By simply submerging the electrode to a sample, the instrument will walk you through the process and will determine the result. This chapter explains about the settings and procedures of measurement using the ION standard addition method and the pharmaceutical water inspection methods under various Pharmacopeias by conductivity measurement.

7.1 Standard Addition Method Mode

7.1.1 Measurement Using Standard Addition Method

The standard addition method is classified as the known addition method and the known subtraction method. The sample addition method and the sample subtraction method are available as applied methodology.

These methods are effective when the composition varies depending on the sample and it is difficult to control conditions such as pH and ionic strength.

In the addition method mode, you can save the measurement results only to a USB memory. They can also be printed out. If you need to save or print out the data, "Simultaneously Memory" of "2.6 USB Memory Setting" (P.21) or "Auto Printout" of "2.7 Printer Setting" (P.23) to ON in advance.

NOTE

Refer to JIS K0122 for standard addition method.

7.1.2 Known Addition Method and Sample Addition Method

● Known addition method

For the known addition method, a small amount of standard solution for the target ion species is added to the sample to increase the concentration of the target ion by a certain amount. The original ion concentration is obtained from the change in electric potential when the standard solution is added.

Known addition method (Single)

The standard solution for the target ion species is added only once to the sample solution.

Known addition method (Double)

The standard solution for the target ion species is added twice to the sample solution. This mode is used to obtain the electric potential slope of the electrode used.

● Sample addition method

For the sample addition method, a small amount of sample is added to the standard solution for the target ion species, to increase the concentration of the target ion. The original ion concentration is obtained from the change in electric potential when the sample is added.

Sample addition method (Single)

The sample is added only once to the standard solution of the target ion species.

Sample addition method (Double)

The sample is added twice to the standard solution of the target ion species. This mode is used to obtain the electric potential slope of the electrode used.

7.1.3 General Cautions for Standard Addition Method



In order to obtain more accurate and reliable data, pay attention to the following points.

- Avoid coexistence of the ions with low coexisting tolerance limit.
Refer to instruction manual of Ion electrode for "Effect of coexisting substance".
- Avoid coexistence of interfering ions.
- In the known addition method (Double) and sample addition method (Double), the electric potential slope of the ion electrode are obtained with approximation formulas after the sample or standard solution is added. Therefore, it is not necessary to perform calibration or check the electric potential slope before the measurement. However, the following condition may affect the measurement results.
 - If the linearity of the electrode used is poor
 - If the electric potential slope is greatly different from the theoretical values (Nernst coefficient)
 - If the sample temperature shifted significantly
- After sample or standard solution is added, sufficiently stir the sample.

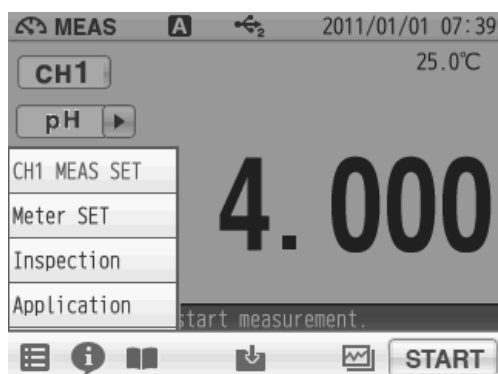
7.1.4 Standard Addition Method MEAS Screen



In the known addition method (Single), the targeted ion concentration in a sample solution is obtained from a change in electric potential by adding once a small amount of the target ion solution to the sample solution.

1. Tap  and tap "Application".
2. Tap  on the right of the ION std. addition mode item.
3. Tap  on the right of the TEMP setting item and tap ATC or MTC.

NOTE

The temperature setting in ION standard addition mode is independent from ION measurement. Therefore, the temperature setting set in ION measurement is not applied.

7.1.5 Known Addition Method (Single) Measurement

In the known addition method (Single), the targeted ion concentration in a sample solution is obtained from a change in electric potential by adding once a small amount of the target ion solution to the sample solution.

Measurement condition setting

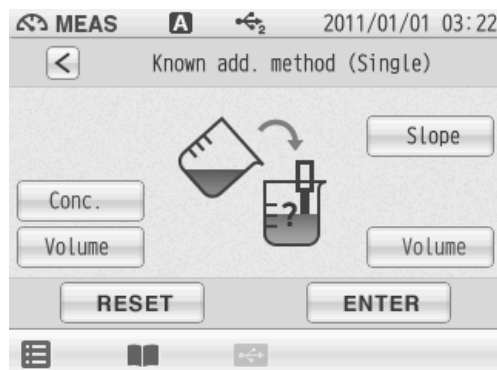

1. Tap on the right of the known addition method item in the ION standard addition mode screen.
2. Tap on the right of the Known add. method (Single) item.
3. Set the measurement condition in the Known add. method (Single) screen.
Enter sample volume, concentration and volume of the standard solution to be added, and electrode slope.
4. Tap after completing the setting.
The MEAS screen is displayed.

To return the set value to default, tap the .

Setting item and range

Concentration of the additive standard solution: 0.1 mg/L to 19000.0 mg/L

Volume of the additive standard solution: 0.01 mL to 1000.00 mL

Electrode slope: -99.99 mV/dec to +99.99 mV/dec

Sample volume: 1.0 mL to 19999.9 mL

HINT!

For more accurate measurement:

Normally, the amount of the standard solution to be added should be from 0.1% to 10% of the sample solution. It is desirable that when the standard solution is added to the sample solution, the concentration of the ion species under measurement increase by 1 time to 10 times in the sample solution. If the concentration of the added standard solution is too low or if the volume of the added standard volume is larger than that of the sample, a large error may occur in the measurement result.

-
5. Immerse the ion electrode in sample solution and tap .
 - The measurement starts. When the indication stabilizes, the HOLD indicator lights up and the measurement value is determined.
 6. Tap to proceed to the next measurement.

- Immerse the ion electrode in sample solution after the additive standard solution and tap **START**.

The measurement starts.

When the measurement is completed, concentration of the sample and the measuring condition are displayed as measurement results.

Tap **CLOSE** to return to the ION standard addition mode screen.

7.1.6 Known Addition Method (Double) Measurement

This mode is used to obtain the concentration of the ion species under measurement by adding a small amount of the target ions to the sample solution twice, thus increasing the ion concentration of the target component, and then measuring the change in electric potential at that time.

Measurement condition setting

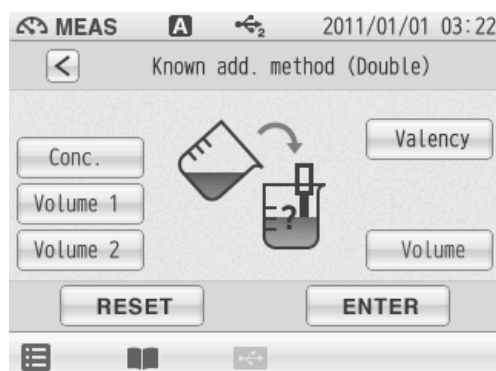

- Tap **>** on the right of the Known addition method item in the ION standard addition mode screen.
- Tap **>** on the right of the Known add. method (Double) item.
- Set the measurement condition in the Known add. method (Double) screen.
Enter sample volume, concentration of the additive standard solution, volume of the 1st and 2nd standard solution and ion valency of measurement ion.
- Tap **ENTER** after complete setting.
The MEAS screen is displayed.

To return the set value to default, tap the **RESET**.

Setting item and range

Concentration of the additive standard solution:	0.1 mg/L to 19000.0 mg/L
Volume of the additive standard solution 1, 2:	0.01 mL to 1000.00 mL
Ion valency:	+2, +1, -1, -2
Sample volume:	1.0 mL to 19999.9 mL

NOTE

Refer to the instruction manual of the ion electrode for the ion valency.

HINT!

For more accurate measurement:

Normally, the amount of the standard solution to be added should be from 0.1% to 10% of the sample solution. It is desirable that when the standard solution is added to the sample solution, the concentration of the ion species under measurement increase by 1 time to 10 times in the sample solution. If the concentration of the added standard solution is too low or if the volume of the added standard volume is larger than that of the sample, a large error may occur in the measurement result.

5. Immerse the ion electrode in sample solution and tap **START** .
The measurement starts. When the indication stabilizes, the HOLD indicator lights up and the measurement value is determined.
6. Tap **STOP** to proceed to the next measurement.
7. Immerse the ion electrode in the 1 standard solution and tap **START** .
The measurement starts.
8. Tap **STOP** to proceed to the next measurement.
9. Immerse the ion electrode in the 2 standard solution and tap **START** .
The measurement starts.
When the measurement is completed, concentration of the sample and the measuring condition are displayed as measurement results.
Tap **CLOSE** to return to the ION standard addition mode screen.

7.1.7 Sample Addition Method (Single) Measurement

This mode is used to obtain the ion concentration of the target ion species by adding a small amount of the sample to the standard solution for the ion species to measure once, thus increasing the ion concentration of the target component, and then measuring the change in electric potential which occurs at that time.

Measurement condition setting

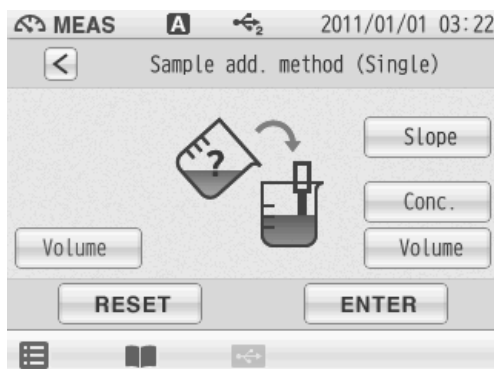

1. Tap **>** on the right of the Sample addition method item in the ION standard addition mode screen.
2. Tap **>** on the right of the Sample add. method (Single) item.

3. Set the measurement condition in the Sample add. method (Single) screen.
Enter sample volume, concentration of the additive standard solution, volume of the additive standard solution and electrode slope.

4. Tap **ENTER** key after complete setting.
The MEAS screen is displayed.

To return the set value to default, tap the **RESET**.

Setting item and range

Volume of the additive sample solution:	0.01 mL to 1000.00 mL
Electrode slope:	-99.99 mV/dec to +99.99 mV/dec
Concentration of the standard solution:	0.1 mg/L to 19000.0 mg/L
Standard solution volume:	1.0 mL to 19999.9 mL

HINT!

For more accurate measurement:

Normally, the amount of the standard solution to be added should be from 0.1% to 10% of the sample solution. It is desirable that when the standard solution is added to the sample solution, the concentration of the ion species under measurement increase by 1 time to 10 times in the sample solution. If the concentration of the added standard solution is too low or if the volume of the added standard volume is larger than that of the sample, a large error may occur in the measurement result.

5. Immerse the ion electrode in standard solution and tap **START**.
The measurement starts.

When the measurement is completed, concentration of the sample and the measuring condition are displayed as measurement results.

Tap **CLOSE** to return to the ION standard addition mode screen.

7.1.8 Sample Addition Method (Double) Measurement

This mode is used to obtain the concentration of the ion species under measurement by adding a small amount of sample to standard solution for the ion species to measure twice, thus increasing the ion concentration of the target component, and then measuring the change in electric potential at that time.

Measurement condition setting

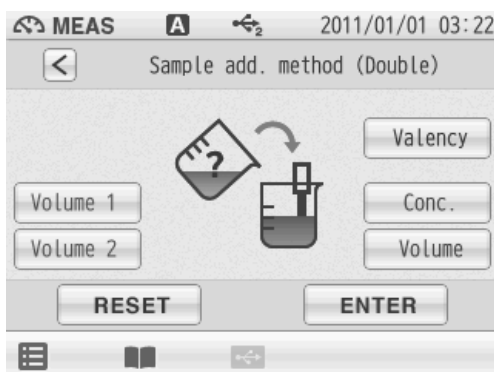

1. Tap **>** on the right of the Sample addition method item in the ION standard addition mode screen.

2. Tap **>** on the right of the Sample add. method (Double) item.

3. Set the measurement condition in the Sample add. method (Double) screen.
Enter the 1 and 2 volume of the additive sample, concentration of the standard solution, volume of the standard solution and ion valency of measurement ion.

4. Tap **ENTER** after complete setting.
The MEAS screen is displayed.

To return the set value to default, tap the **RESET**.

Setting item and range

Volume of the additive sample 1, 2:	0.01 mL to 1000.00 mL
Ion valency:	+2, +1, -1, -2
Concentration of the standard solution:	0.1 mg/L to 19000.0 mg/L
Standard solution volume:	1.0 mL to 19999.9 mL

HINT!

For more accurate measurement:

Normally, the amount of the standard solution to be added should be from 0.1% to 10% of the sample solution. It is desirable that when the standard solution is added to the sample solution, the concentration of the ion species under measurement increase by 1 time to 10 times in the sample solution. If the concentration of the added standard solution is too low or if the volume of the added standard volume is larger than that of the sample, a large error may occur in the measurement result.

5. Immerse the ion electrode in sample solution and tap **START**.

The measurement starts. When the indication stabilizes, the HOLD indicator lights up and the measurement value is determined.

6. Tap **STOP** to proceed to the next measurement.

7. Immerse the ion electrode in the 1 sample solution and tap **START**.

The measurement starts.

8. Tap **STOP** to proceed to the next measurement.

9. Immerse the ion electrode in the 2 sample solution and tap **START**.

The measurement starts.

When the measurement is completed, concentration of the sample and the measuring condition are displayed as measurement results.

Tap **CLOSE** to return to the ION standard addition mode screen.

Chapter 8 Periodic Inspection Mode

This chapter explains about the function to periodically check performance of the instrument and the electrode in pH, ION, and COND measurements using. We recommend that you perform the check once every 3 months. Setting conditions are described individually in each pH, ION, and COND measurement item.

8.1 pH Periodic Inspection Mode Setting

There are three modes for the pH periodical check: JIS mode, Pharmacopoeia mode, or Simulator (X-51) mode.

JIS mode

This mode conforms to the JIS Z8802-1984.

Using the combination of electrode and the instrument, you can check the coincident format of the JIS by standard solutions of pH7, pH4 and pH9 .

Pharmacopoeia mode

This mode conforms to the Japanese Pharmacopoeia 16th edition.

After measurement by standard solutions of pH7 and pH4, the measurement of the solution of pH7 is given five times, and the repeatability is confirmed.

Simulator (X-51) mode





Optional pH simulator (X-51) checks the meter only (electrode check is not included).

NOTE

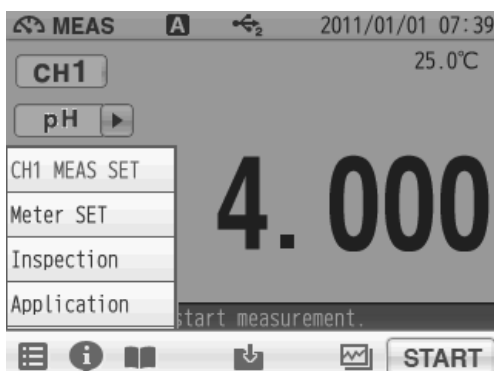
- The JIS and Pharmacopoeia modes are based on the corresponding regulations, but not fully compliant with the regulations. Note that the modes may not follow the regulations if the regulations are revised or amended.
 - Set the indicated resolution to 0.001 pH in "3.6 Indicated Resolution of pH Measurement Values Setting" (P.44).
-

8.1.1 Settings



1. Tap , and tap "Inspection".
2. Tap  when displayed the periodic inspection select screen, and tap "CH1 CAL SET". Display the pH periodic inspection item.
3. Tap  on the right of the pH periodic inspection item, and tap the pH periodic inspection method. The setting applies. The check mark on the current setting item is displayed. To cancel the settings, tap .

The setting of pH periodic inspection mode is completed. Hereinafter, how to set each pH periodical inspection item is described.

8.1.2 JIS Mode

According to JIS regulation, the measurement with a solution of pH9 is given three times after measurement by standard solutions of pH7 and pH4. The result is displayed on the screen. When the periodic inspection mode starts, the operation guide is shown on the screen.

Perform measurement by the standard solutions in the following order.

- (1) pH6.865
- (2) pH4.008
- (3) pH9.180
- (4) pH9.180
- (5) pH9.180

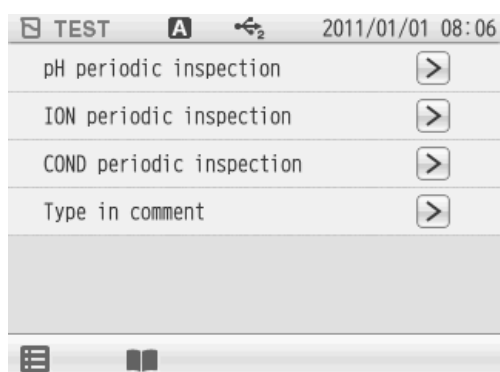

1. Immerse the pH electrode in the standard solution, and tap **START** to start measurement.
2. Perform measurement of each standard solution in accordance with the content displayed on the bottom of the screen.

NOTE

Cautionary points

- Wash the electrode with pure water before each measurement.
 - Keep the temperature gap during the measurement within 0.2°C.
 - The measurement values during the periodical check are displayed according to those when the calibration is cleared.
-

When the measurement and check is completed, the result data is displayed.

Result data output

(1) Judgment

OK: The result data satisfies the regulation

CHECK: The result data does not satisfy the regulation

(2) Calibrated value

Calibrated value for each standard solution of pH7, 4, and 9, potential, and temperature.

(3) Average value for pH9

Average of the three-time measurement with standard solution of pH9.

(4) Asymmetric potential

Within regulated values ± 30 mV

(5) Sensitivity

pH4 to pH7 (90% to 105% of regulated value)

pH7 to pH9 (90% to 105% of regulated value)

(6) Repeatability

The repeatability shows the difference between maximum and minimum of the indication given by three times of measurements using the standard solution of pH9 (see the values (3), (4), and (5) above).

OK (0)	Within ± 0.005 pH	Equivalent to 0 in JIS
OK (1)	Within ± 0.02 pH	Equivalent to I in JIS
OK (2)	Within ± 0.05 pH	Equivalent to II in JIS
NG	Over ± 0.05 pH	-

(7) Linearity

Regulation (Within ± 0.03 pH)

This is equivalent to "0" and "I" in JIS.

The difference between pH9 theoretical value, which was obtained from measurement values of pH7 and pH4, and the average of 3 pH9 measurements, is indicated.

● For accurate measurement

The regulation equivalent to "0" in JIS is quite strict, accordingly it requires strict measurement condition to meet this regulation.

To insure accuracy in the measurement:

- Use Type 1 for the pH standard solution.
- Keep the temperature within $\pm 0.2^\circ\text{C}$ by a temperature controlled bath.
- Set the temperature in the temperature controlled bath to room temperature (25°C) or equivalent.
- Perform light stirring using the electrode stand and a stirrer.
- Press HOLD after the measured values completely stabilizes.

HINT!

Typical time interval for the measurement values to become stabilized is 3 minutes to 10 minutes while the electrode is immersed into the standard solution.

● When electrodes are defective

When the above measurement does not solve the defective conditions, perform the followings.

- Clean the electrode.
- Confirm the right standard solution is used.
- Check if the electrode is deteriorated, and replace it to new one if necessary.

8.1.3 Pharmacopoeia Mode

After measurement with the standard solutions of pH7 and pH4 (or pH9), the measurement using the standard solution of pH7 is repeated 5 times, and the result is displayed. These check procedures conform to the regulation of the Japanese Pharmacopoeia (JP).



1. Immerse the pH electrode in the standard solution, and tap **START** to start measurement.
2. Perform measurement of each standard solution in accordance with the content displayed on the bottom of the screen.

NOTE

Cautionary points

- Wash the electrode with pure water before each measurement.
- Keep the temperature gap during the measurement within 0.2°C.
- The measurement values during the periodical check are displayed according to those when the calibration is cleared. The result values are displayed according to those in the periodic inspection mode.

Perform measurement by the standard solutions in the following order.

- (1) pH6.865
- (2) pH4.008 (or pH9.180)
- (3) pH6.865
- (4) pH6.865
- (5) pH6.865
- (6) pH6.865
- (7) pH6.865

- Wash the electrode with pure water before each measurement.
- The measured values during periodical check are based on the values when the calibration is cleared.

When the calibration range error occurs either at step (1) and/or (2), the screen displays the error and the check procedures automatically stop.

When the measurement and check is completed, the result data is displayed.

Result data output

When all the check is completed, the result is outputted automatically.

- OK/CHECK judge

 - Electrode: OK (satisfies regulation requirements)

 - CHECK (does not satisfy regulation requirements)

- Calibrated value for each standard solution of pH7, 4, or 9, potential, and temperature.

- Asymmetric potential (within regulated value ± 30 mV)

- Sensitivity pH4 to 7 (90% to 105% of regulated value)

 - pH7 to 9 (90% to 105% of regulated value)

- Repeatability (within regulated value ± 0.05 pH)

 - The repeatability shows the difference between maximum and minimum results given by 5 measurements using the standard solution of pH7.

To insure accuracy in the measurement;

- Use Type 1 for the pH standard solution.
- Keep the temperature within $\pm 0.2^\circ\text{C}$ using a temperature controlled bath.
- Set the temperature in the temperature controlled bath to room temperature (25°C) or equivalent.
- Perform light stirring use the electrode stand and a stirrer to stir samples lightly.
- Hold a measured value after it completely stabilizes.

HINT!

It takes 3 minutes to 10 minutes for measurement values to stabilize since the electrode is immersed into the standard solution.

- **When an electrode is defective**

If the check result is wrong even in the above operations, try following countermeasures.

- Clean the electrode.
- Check the used standard solutions are right.
- Check if the electrode is deteriorated, and replace with new one if necessary.

8.1.4 Simulator (X-51) Mode

Input the results given by the optional pH checker, X-51 to the meter, and perform functional check.

For detailed operation, refer to the instruction manual for the pH checker X-51.

1. Set the resolution to 0.001 pH in the pH SETUP screen.
2. Set the temperature compensation to ATC.
3. According to the operation guide, perform functional check as calibration by the standard solutions of pH7, pH4 in the following order.
 - (1) Calibration by standard solutions
 - pH6.865
 - pH4.008

(2) Linearity check

pH0.000
pH4.000
pH7.000
pH10.000
pH14.000

(3) Indication check by inputting high impedance

Input pH0.000
Input pH14.000

(4) Temperature indication check

The displayed pH values at this time have nothing to do with the check result.

0.0°C
30.0°C
60.0°C
100.0°C

When the measurement and check is completed, the result data is displayed.

Result data output

● OK/CHECK

OK (satisfies regulation requirements)

CHECK (does not satisfy regulation requirements)

● Calibration

● Asymmetric potential (within regulated value ± 3 mV)

● Sensitivity (99% to 101% of regulated value)

● Linearity

Indication error at each input (regulated value ± 0.010 pH ± 1 digit)

● High impedance

Indication error at each input (regulated value ± 0.030 pH ± 1 digit)

● Temperature Indication error at each input (regulated value ± 0.4 °C)

When the judgment of "CHECK" is displayed, check the connection and repeat the check.

When the error repeatedly occurs, call the customer service.

8.2 ION Periodic Inspection Mode Setting

In the ION periodical check mode, the instrument operations are checked by inputting the output of the optional checker X-51 into the instrument.

Refer also to the instruction manual of the checker X-51 before the operation.

Set the measurement unit for ion to mol/L before starting the check operation.

After the setting change, the settings apply.

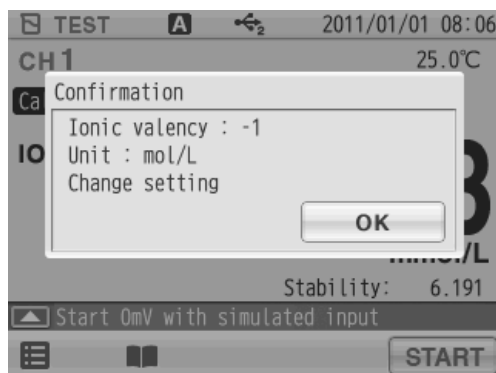

Follow the guidance to calibrate the instrument by simulated input of 0 mV and 120 mV in the order below and check the following operation.

Simulated calibration check

0 mV 1.00 mol/L
120 mV 10.0 mmol/L

Simulated linearity check

240 mV 100 μ mol/L
120 mV 10.0 mmol/L
0 mV 1.00 mol/L
-120 mV 100 mol/L

Simulated temperature check

0.0°C
30.0°C
60.0°C
100.0°C

When all the check is completed, the result is outputted automatically.

8.3 Comment Input

A comment can be entered up to 100 characters. Use this function to record periodical checks, etc.

Tap **INPUT** to use the function.

To delete the content input previously, tap **ALL DEL** .



Chapter 9 Data

The DATA screen allows you to check and delete saved measurement data, check the calibration data, save data into a USB memory, and delete all measurement and calibration data.

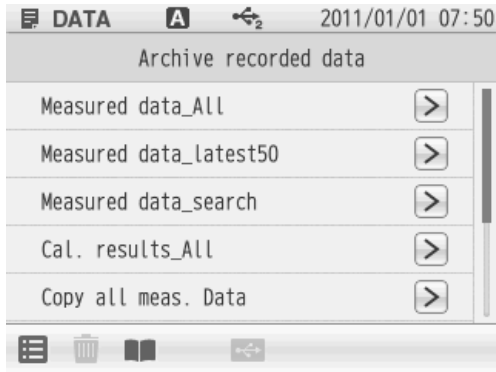



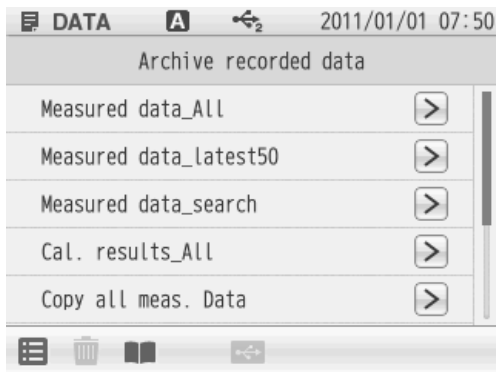

You can search saved data by measurement item, operator, or sample name.

1. Press the DATA key to display the DATA screen.

9.1 Measured data_All





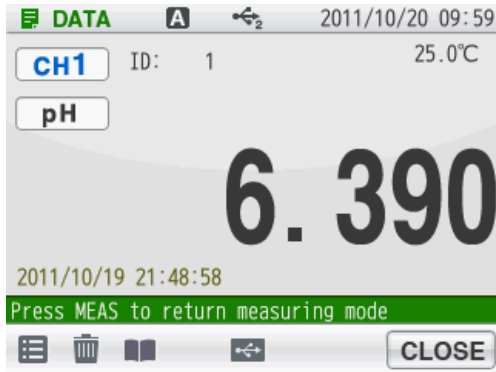

1. Tap  on the right of the Measured data_All item. One item of measured data is displayed in one line. Data can be checked by dragging the item in order. 100 items of data can be viewed on 1 page.
2. Tap   to check other pages. The next 100 items are displayed.
3. Tap  of the each data to check details of the data.
4. Flick on a detailed data screen, and the previous/next detailed data screen is displayed.

9.2 Deleting Saved Data



Data can be deleted selectively.

1. Tap  on a detailed data screen. "DELETE" is displayed under the ID number.
2. Tap  to return the Measured data_All screen. "del" is indicated as the ID of the data to be deleted.
3. After that, tap  to execute deletion. To execute, tap . Not to execute, tap .

9.3 Measured data_latest50

You can check just the latest 50 data.
The data are sorted in descending order of measurement data.

9.4 Measured data_search



You can search saved data by one of measurement item, operator, or sample name. (You cannot use multiple search conditions at a time.)

1. Tap on the right of the Measured data_search item.
 2. Search by measurement date
Enter measurement date in the measurement date search screen, and tap .
 - Search by measurement item
Tap on the right of each measured item.
 - Search by operator name
Enter operator name in input screen, and tap .
 - Search by sample ID
Enter sample name in input screen, and tap .
3. When you select Measured on, enter the measurement date and tap on the next screen.
When you select Measuring mode, tap on a measurement item on the next screen.
When you select User name, enter operator name and tap on the next screen.
When you select Sample ID, enter sample name and tap item on the next screen.
Search is performed and the result is displayed.

9.5 Cal. results_All

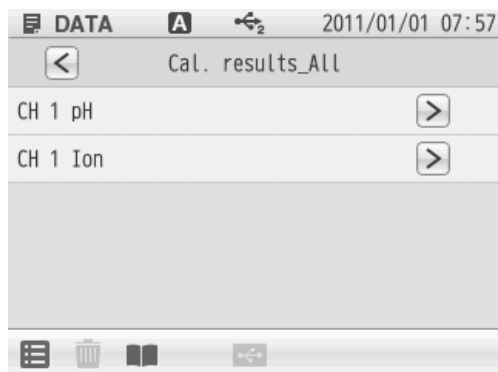

You can check the latest 20 data of pH and ION calibration.

The data are sorted in descending order of calibration data.

1. Tap on the right of the Cal. results_All.
2. Tap on the right of each measured item.
3. Tap on the right of the data to be checked.
4. After the check is completed, tap to return the Cal. Result_All screen.

NOTE

All calibration data, including the ones not used actually because of an error during calibration, are displayed on this screen.

9.6 Copy all meas. Data

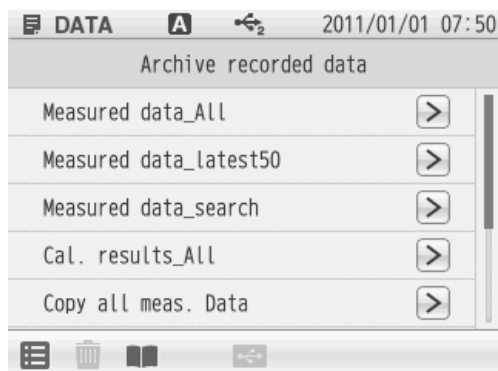

You can save the copy of the measurement data saved in the instrument into a USB memory. To execute the copy, connect a USB memory to the instrument.

1. Tap on the right of the Copy all meas. Data.
2. Tap to copy the all measurement data. To cancel the operation, tap .
3. Tap in the Copy all meas. Data completion screen.

NOTE

Before copying data, make sure that sufficient capacity is available in the USB memory. If the copy stops in the middle, turn OFF the power and reboot the instrument, and then execute the copy again.

9.7 Delete all meas. Data



You can delete all measurement data saved in the instrument.

1. Tap on the right of the Delete all meas. Data
2. Tap to delete the all measurement data. To cancel the operation, tap .
3. Tap in the Delete all meas. DATA screen.

9.8 Delete all cal. data



You can delete all calibration history data saved in the instrument.

If you want to delete the latest calibration data, tap on the calibration screen of each measurement item.

1. Tap on the right of the Delete all cal. data.
2. Tap to delete the all calibration history data. To cancel the operation, tap .
3. Tap on the Delete all cal. data completion screen.

Chapter 10 Specifications

10.1 Model Information

Item	Description
Brand (pet name)	LAQUA
Series name	Benchtop pH/Water Quality Analyzer
Model	F-72G
Model description	pH/ION METER

10.2 Measuring Object

Measuring object	Item	Description
pH	Measuring principle	Glass electrode
	Display range	pH-2.000 to pH20.000
	Measuring range	pH0.000 to pH14.000
	Resolution	0.01 pH, 0.001 pH
	Repeatability	±0.001 pH ±1 digit
Temperature	Measuring principle	Thermistor method
	Display range	-30.0°C to 130.0°C
	Measuring range	0.0°C to 100.0°C
	Resolution	0.1°C
	Repeatability	±0.1°C ±1 digit
mV (ORP)	Measuring range	±1999.9 mV
	Resolution	0.1 mV
	Repeatability	±0.1 mV ±1 digit
ION	Measuring principle	Ion electrode
	Measuring range	0.000 µg/L to 9999 g/L (µg/L, mg/L, g/L, mmol/L, mol/L)
	Resolution	Valid numbers 4 digits
	Repeatability	±0.5% ±1 digit of full scale

10.3 Default Settings

10.3.1 Meter Default Settings

Item		Selection item/Setting range	Default values
Security	Security management function	Enable, Disable	Disable
Hold condition	Hold setting mode	EXACT, NORMAL, BRIEF, TIME, CUSTOM, OFF (Manual)	NORMAL
In selecting "TIME"	Time setting value	2 seconds to 999 seconds	10 seconds
In selecting "CUSTOM"	Time setting value	2 seconds to 60 seconds	10 seconds
	pH variation width	0.001 pH to 0.100 pH	0.005 pH
	mV variation width	0.1 mV to 60.0 mV	0.3 mV
	ORP variation width	0.1 mV to 60.0 mV	0.3 mV
	Ion variation width	0.1 mV to 60.0 mV	0.3 mV
Interval memory	Interval memory function	Enable, Disable	Disable
	Time setting value	1 second to 999 seconds	30 seconds

10.3.2 Measurement Condition Default Settings (Can Be Set per Operator)

Item		Selection item/ Setting range	Default values	
pH measurement condition	Alarm condition	Upper limit value setting	Enable, Disable	Disable
		Lower limit value setting	Enable, Disable	Disable
		Upper limit value	0.000 pH to 14.000 pH	14.000 pH
		Lower limit value	0.000 pH to 14.000 pH	0.000 pH
	Resolution		0.01, 0.001, AUTO	0.001
	Temperature setting	Temperature setting	ATC (Automatic temperature compensation), MTC (Manual temperature compensation)	ATC
		Temperature input value in selecting "MTC"	0.0°C to 100.0°C	25.0°C
	Temperature conversion	Temperature conversion function	Enable, Disable	Disable
		Temperature conversion coefficient	±0.100 pH/°C	0.000 pH/°C
		Standard temperature	0.0°C to 100.0°C	0.0°C
	Electrode data	Model		None
		lot No.		None
	pH calibration condition	Standard solution		NIST, NIST2, USA, China, CUSTOM
Calibration points		1 point to 5 points	2 points	
Calibration interval setting		Enable, Disable	Disable	
Calibration interval		1 day to 999 days	3 days	
Preliminary check		Enable, Disable	Disable	
Periodical check		JIS, Pharmacopeia, X-51 (Digital simulator)	X-51	

Item		Selection item/ Setting range	Default values	
ORP measurement condition	Alarm condition	Upper limit value setting	Enable, Disable	Disable
		Lower limit value setting	Enable, Disable	Disable
		Upper limit value	±1999.9 mV	1999.9 mV
		Lower limit value	±1999.9 mV	-1999.9 mV
	Temperature setting	Temperature setting	ATC (Automatic temperature compensation), MTC (Manual temperature compensation)	ATC
		Temperature input value in selecting "MTC"	0.0°C to 100.0°C	25.0°C
	Electrode data	Model		None
		lot No.		None
mV measurement condition	Alarm condition	Upper limit value setting	Enable, Disable	Disable
		Lower limit value setting	Enable, Disable	Disable
		Upper limit value	±1999.9 mV	1999.9 mV
		Lower limit value	±1999.9 mV	-1999.9 mV
	Temperature setting	Temperature setting	ATC (Automatic temperature compensation), MTC (Manual temperature compensation)	ATC
		Temperature input value in selecting "MTC"	0.0°C to 100.0°C	25.0°C
	Electrode data	Model		None
		lot No.		None

Item		Selection item/ Setting range	Default values	
Ion measurement condition (For ion type)	Alarm condition	Upper limit value setting	Enable, Disable	Disable
		Lower limit value setting	Enable, Disable	Disable
		Upper limit value	0.000 µg/L to 9999 g/L	9999 mg/L
		Lower limit value	0.000 µg/L to 9999 g/L	0.000 mg/L
	Measurement value unit		µg/L, mg/L, g/L, mmol/L, mol/L	mg/L
	Ion valency		+2, +1, -1, -2	+1
	Ion type		+1 Na, K, NH ₄ , Ag, X -1 CN, Cl, I, Br, SCN, F, NO ₃ +2 Cu, Cd, Pb, Ca, X ₂ -2 S ₂ , X ₂	X
	Temperature setting	Temperature setting	ATC (Automatic temperature compensation), MTC (Manual temperature compensation)	ATC
		Temperature input value in selecting "MTC"	0.0°C to 100.0°C	25.0°C
	Electrode data	Model		None
lot No.			None	
Ion calibration condition	Calibration points	1 point to 5 points	2 points	
	Preliminary check	Enable, Disable	Disable	
Sample ID			None	

Item		Selection item/ Setting range	Default values	
Interface condition	Language	Japanese, English, Chinese, Korean, Vietnamese	English	
	Screen setting	Screen theme	STANDARD, COOL, MONOTONE, KYOTO	STANDARD
		Brightness	1 to 10	5
		Power saving mode	Enable, Disable	Disable
		Back light off time	1 minute to 999 minutes	60 minutes
	Sound setting	Volume	0 to 9	5
		Sound theme	STANDARD1, STANDARD2, AQUA, KYOTO	STANDARD1
	Printer setting	Automatic printing	Enable, Disable	Disable
		Printing format	BRIEF, NORMAL, GLP, CUSTOMIZE	NORMAL
	USB memory	Simultaneous memory	Enable, Disable	Disable

10.4 Options

This section lists spare and optional parts for LAQUA series. These parts are possible through our representatives in your region. Place an order specifying their name, model, and part number.

Part name		Part number	Remarks
AC adapter		3200647413	With 6 plug adapters
Plain paper printer	Printer (USA, 120 V)	3014030146	Printer cable sold separately
	Printer (EU, 230 V)	3014030147	
	Printer cable	3014030148	1.5 m
	Roll paper	3014030149	20 rolls/set
	Ink ribbon	3014030150	5 pcs/set
USB cable		3200373941	1 m
Serial cable		3014030151	
Analog (alarm) output cable		3014030152	
Electrode stand (Standard type)		3200382557	
Electrode stand (Long type)		3200382560	
Stand arm		3200373991	
Sensor holder		3200373961	
X-51 Digital Simulator		—	For pH, mV, ION, and DO
X-52 Digital Simulator		—	For COND

HORIBAAdvanced Techno

31, Miyanonishi-cho, Kisshoin Minami-ku, Kyoto 601-8306, Japan

<http://www.horiba-adt.jp>

For any questions regarding this product, please contact your local agency, or inquire from the following website.

http://global.horiba.com/contact_e/index.htm

