



USER MANUAL

BD/TL Series

Index:

1. General description	3
2. Completeness	3
3. Security rules.....	4
4. Technical data	5
5. General view of balance	6
6. Keys and indicators	8
7. Preparation of workplace.....	11
8. Preparation to work	11
9. General rules.....	12
10. Operation rules during work with accumulators (batteries)	13
11. Accumulator exchange	14
12. Start of work	15
13. Pieces counting (PCS)	15
14. Summation of measurements series (Σ)	18
15. Permanent tare memory ($\rightarrow PT$).....	19
16. Products data library ($\leftrightarrow MEM$ key)	20
17. Connecting to computer or printer	23
18. Basic function description.....	25
18.1 Zeroing scale indication.....	25
18.2 Tare	26
19. User menu.....	27
Maintenance and repairs of small defects	32

1. General description

BD/TL series scales are destined for identical pieces counting and can be used in store houses production control and similar tasks.

Counting pieces function is based on calculation individual mass of detail from sample weight or inscribed value using keyboard. Scale avails a "learn algorithm" during calculation to correct inaccuracy conversion.

BD/TL is equipped with summing register. The register allows addition or subtraction of successive measurement and observation of the register current state.

BD/TL is equipped with data library (products base) that enables to save up to 1000 products, wherein 30 products can be saved to handy data library (that enables choosing product by using only one key).

Most effective way to work with products labeled by barcode e.g. EAN13 is to use connection with barcode reader (option). Readout of barcode recalls product from data library (products base).

Scale conforms European Union safety regulations and is marked with CE sign.

PKWiU classification: : 33.20.31.

2. Completeness

Standard set consist of:

1. Scale
2. Support pan
3. Overlay pan
4. Feeder
5. Accumulator – 1 piece (option)
6. User manual
7. Guarantee card

3. Security rules

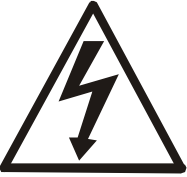
	<p>To avoid electrical shock or damage of the scale or connected peripheral devices, it is necessary to follow the security rules below.</p>
<ul style="list-style-type: none">• All repairs and necessary regulations can be made by authorised personnel only.• To avoid fire risk use a feeder of an appropriate type (supplied with the scale). Pay attention that supply voltage is compatible with specified technical data.• Do not use the scale when its cover is opened.• Do not use the scale in explosive conditions.• Do not use the scale in high humidity.• If the scale seems not to operate properly, unplug it from the mains and do not use until checked by authorised service.	

	<p>According to legal regulations it is forbidden to dispose of wasted electronic equipment in waste containers.</p>
<ul style="list-style-type: none">• Please return the wasted scale to the point of purchase or other company specialised in recycling of wasted electronic components.	

4. Technical data

Scale type	BD1.5TL	BD3TL	BD6TL	BD15TL	BD30TL
Load (Max)	1.5kg	3kg	6kg	15kg	30kg
Readout unit (d)	0,5g *0,05g	1g *0,1g	2g *0,2g	5g *0,5g	10g *1g
Tare range	-1.5kg	-3kg	-6kg	-15kg	-30kg
Pan dimensions	300x210mm				
Working temperature	-10°C ÷ +40°C				
Weighing time	<3s				
Scale dimensions	335x320x110mm				
Scale weight	3,5kg				
Supply	~230V 50Hz 6VA / =12V 1,2A (external feeder)				
Accumulator	EP 4.5 - 6 (4,5Ah 6V)				
Products base: - Handy products quantity - All products quantity Users bank: - Users quantity	2 x 15 products 1000 products 5 users				
Continuous working time on accumulators 2200mAh	about 48 h with display backlighting about 100h without backlighting				
Automatic turn-Off time when with accumulators	> 5 min (AutoOFF function)				
Backlighting automatic turn-off when with accumulators	> 30 s (b_LIGHT function)				

**optional readout units designed not for verification (on demand)*

Scale type	BD3TLY	BD6TLY	BD12TLY	BD30TLY
Load (Max)	3kg	6kg	12kg	30kg
Readout unit (d)	0,5g	1g	2g	5g
Verification unit (e)	0,5g	1g	2g	5g
Tare range	-3kg	-6kg	-12kg	-30kg
Class	III			
Pan dimensions	300x210mm			
Work temperature	-10°C ÷ +40°C			
Weighing time	<3s			
Scale dimensions	335x320x110mm			
Scale weight	3,5kg			
Supply	~230V 50Hz 6VA / =12V 1,2A (zasilacz zewnętrzny)			
Accumulator	EP 4.5 - 6 (4,5Ah 6V)			
Products base: - Handy products quantity - All products quantity Users bank: Users quantity	2 x 15 products 1000 products 5 users			
Continuous working time on accumulators 2200mAh	about 48 h with display backlighting about 100h without backlighting			
Automatic turn-Off time when with accumulators	> 5 min (AutoOFF function)			
Backlighting automatic turn-off when with accumulators	> 30 s (b_LIGHT function)			

5. General view of balance

Front view:

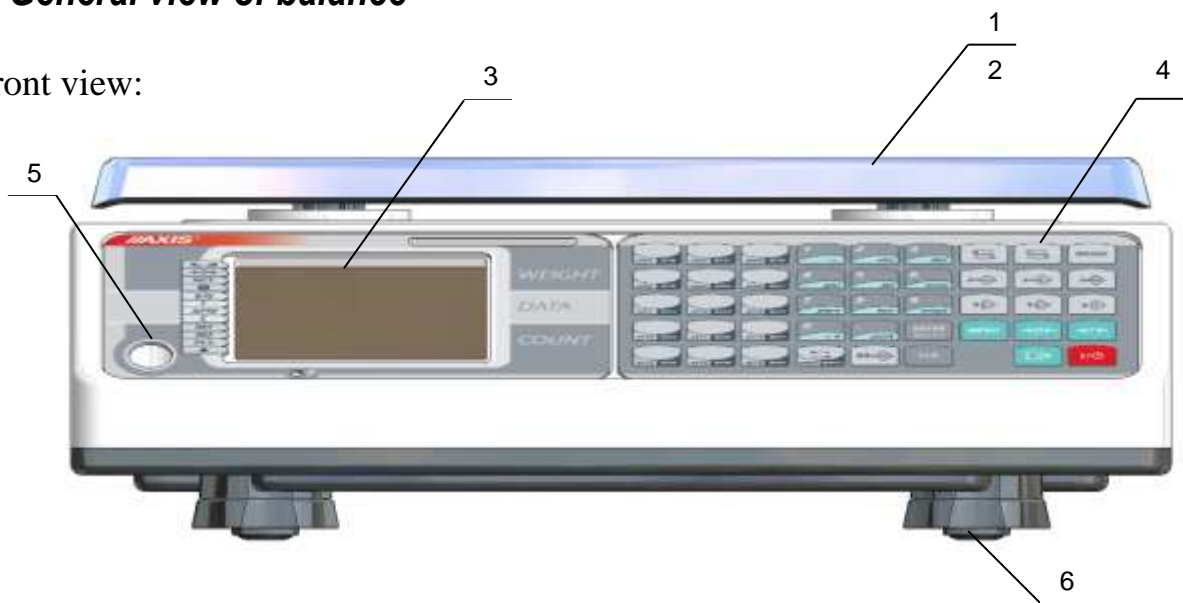

- | | |
|------------------------------------|-----------------|
| 1 – Overlay pan | 4 – keyboard |
| 2 – support pan (under overlay p.) | 5 – level |
| 3 – display | 6 – rotary legs |

Back view:



Back view - option with additional displays:

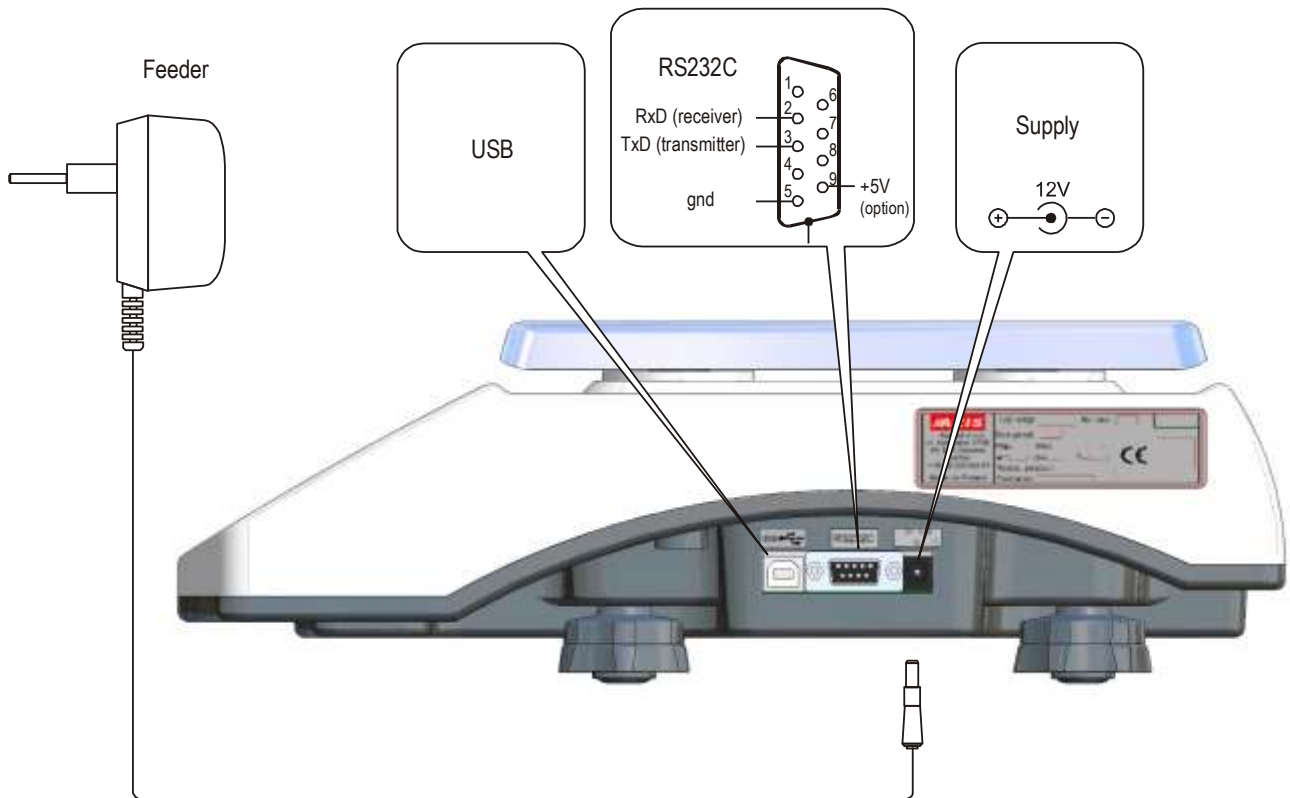

Interfaces view:

**Attention:**

+5V (option) supply in RS232C joint is installed only in scales ordered together with a scanner. In that case the scanner doesn't need feeder.

6. Keys and indicators

Keys placement:



Keys description:



- turn on/off,



- print key (complies with port and print settings),



- scale zeroing key (verified scale),



- scale tare key,



- **short press** – enter user menu,
 - **hold** – enter user identification menu (when option is active ; release key to choose the actual user that is displayed),



- **short press** – permanent tare menu,
 - **hold** – predefined tare menu (release key to choose the actual tare),



- **short press**- adding actual netto weight / details quantity to TOTAL register,
 - **hold** – TOTAL menu access (release key to choose the actually displayed option)



- **short press** – subtraction of actual netto weight / details quantity from TOTAL register,
 - **hold** –TOTAL menu acces (release key to choose actually displayed option)



- **short press** – pieces counting on (putting defined quantity of pieces on pan),
 - **hold** – PCS menu access (release key to choose actually displayed option),



- **short press** – pieces counting on (taking off pieces from pan),
 - **hold** – PCS menu access (release key to choose actually displayed option),



- DATA display working mode change (in cycles: off/gross/tare/ unitary mas/total/thr),



- unit change (in cycles: g/kg/lb),



- changing mode key (nr or id),



- cancel operation key,



- confirm operation key,



- range switch 1÷15 or 16÷30 for record library,



- **short press** – inserting record number or id (MODE key switches) to recall record from memory,

- **hold** – inserting number or code (MODE key switches) of the record to save/edition,



- unitary mass inserting,

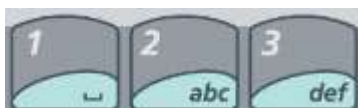

- numerical values keyboard,



- **short press** – fast recalling record 1÷30 from memory (handy products),

- **hold** – save/edition menu of product as 1÷30 record,

Scale indications:

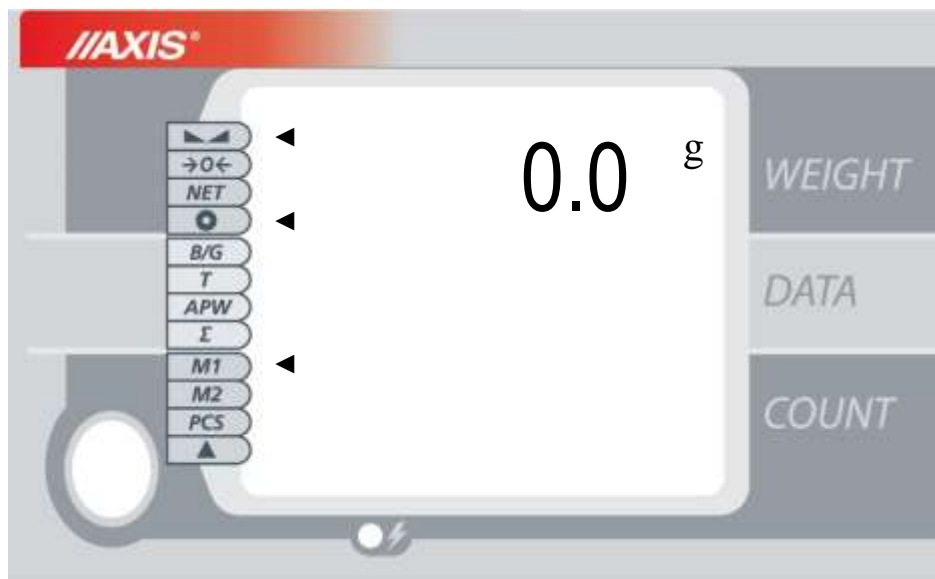

Scale display is divided into three sections: *WEIGHT* - upper, *DATA* - middle and *COUNT* - lower. Each of these sections has its own measurement indication and information indicators that complement main information or describe scale state. Indicator is active when there is a ◀ mark next to it. On above screen ◀, ● and *M1* indicator is active.

In scales with additional displays on the back each display corresponds to proper section (*WEIGHT*, *DATA* i *COUNT*).

Indicators section *WEIGHT*:

- indicator ◀◀ - measurement result stabilization,
- indicator →0← - zeroing indicator (unloaded scale),
- indicator *NET* - netto weight (after using →T← key),
- indicator ● - signalizes active Autotare option (*AutotA*) / in scale's menu indicates if function is on (indicator indicates) or off (without indicator),

Indicators section *DATA*:

- indicator *B/G* - signalizes displaying gross weight,
- indicator *T* - signalizes displaying actual tare,
- indicator *APW* - signalizes displaying average unitary weight,
- indicator Σ - signalizes displaying summing register.

Indicators section *COUNT*:

- indicator *M1* - records baze range 1÷15 active,
- indicator *M2* - records baze range 16÷30 active,
- indicator *PCS* - pieces counting,

- indicator ▲ - signalizes that *APA* option (automatic improving of pieces counting accuracy) is on / in scale's menu indicates if function is on (indicator indicates) or off (without indicator).

7. Preparation of workplace

Workplace of scale should be chosen carefully. This place should be assured a proper temperature and essential area for attendance. Weight should stand on stable table.

Violent movements of air, dust, vibrations, violent changes of temperature or humidity above 90% are inadmissible. Scale should be far off from strong electromagnetically or magnetically fields.

8. Preparation to work

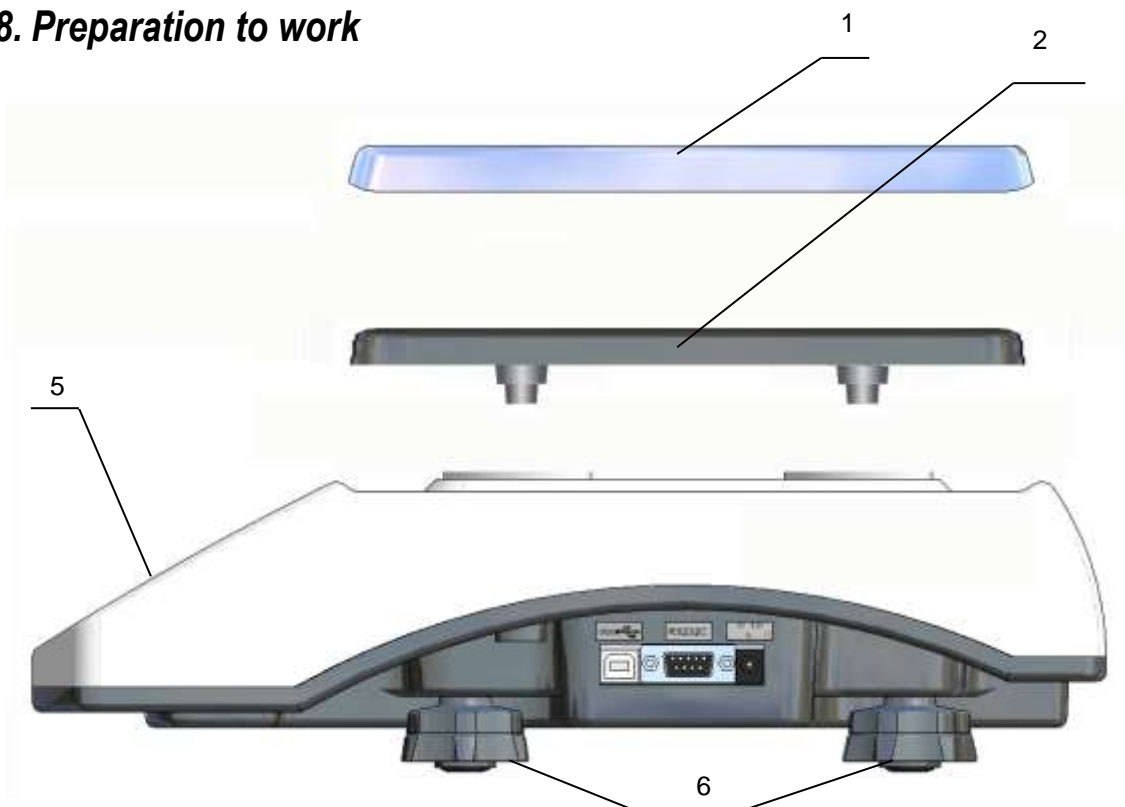

1. Take the scale, pan and feeder out of the package. It is recommended to keep the original scale package in order to transport the balance safely in future.
2. Place the scale on a stable ground not affected by mechanical vibrations and airflows.
3. Put a support pan 2 in wholes.
4. Put the overlay pan 1.
5. Level the scale with the rotating rear legs 6 so that the air bubble in the water-level 5 at the front of the scale is in the middle.



If scale has been moved from places with low temperature to places with high temperature (for example in winter), before connecting the scale to supply leave it for about 4 hours in purpose of acclimatization.

9. General rules

1. It is advised to check scale indication accuracy before and after series of measurement using any load with known weight. To check the scale with legal verification uses a calibration weight with valid calibration certificate. In case permissible error is exceeded it is advised to contact the nearest service to calibrate the scale.
2. Weighed sample should be placed in the centre of the pan.
3. The scale is equipped with a tare equal to its range. To tare the scale press →T← key. Storing a tare value does not extend measuring range, but only subtracts it from a load placed on a pan.
4. Weighing result should be read when the indicator "▾ ▸" lights, which signalizes stabilization of a result.
5. When the scale is not used but it is necessary to be ready to work immediately, it can be switched off by pressing I/⊙ key. The scale reading system is then switched off to "standby" mode. To switch the scale on press I/⊙ key. The scale is immediately ready to operate maximum accuracy (after self tests).
6. Before each measurement make sure that zero indicator is displayed. If zero indicator does not displayed or "----" communicate appears, press →0← key and wait until zero indication and zero indicator appears
7. The mechanism of scale is a precision devices and susceptible on congestions, impacts and mechanical shakes.



Do not overload the scale more then 20% of maximum load (Max).
Do not press a pan by hand.



Scale should be protected during the transport.

10. Operation rules during work with accumulators (batteries)

1. Scale can be powered from ~230V supply through feeder attached with scale. Moreover accumulators, which are placed in container inside the scale, can be used for powering. Ordinary batteries can be used as well.



When using batteries in place of accumulators, charging during work with feeder have to be switched off. *bAttErY* function is used for this purpose (*bAt OFF* option), which is described in further part of manual. Charging batteries can cause their breaking and serious damage of the scale.

2. In order to make accumulators (batteries) discharging time longer, automatic switching off display backlight and later the whole scale further is possible during breaks in weighing. Configuration of these mechanisms is done using *b_LIGHT* and *Auto OFF* functions.

3. Charging accumulators is performed automatically after connecting feeder to the scale, also during weighing. Accumulator power level can be read using *bAttErY* function (*bat LEVEL* option).

11. Accumulator exchange

- 1.Remove the pan carefully.
- 2.Invert the scale.

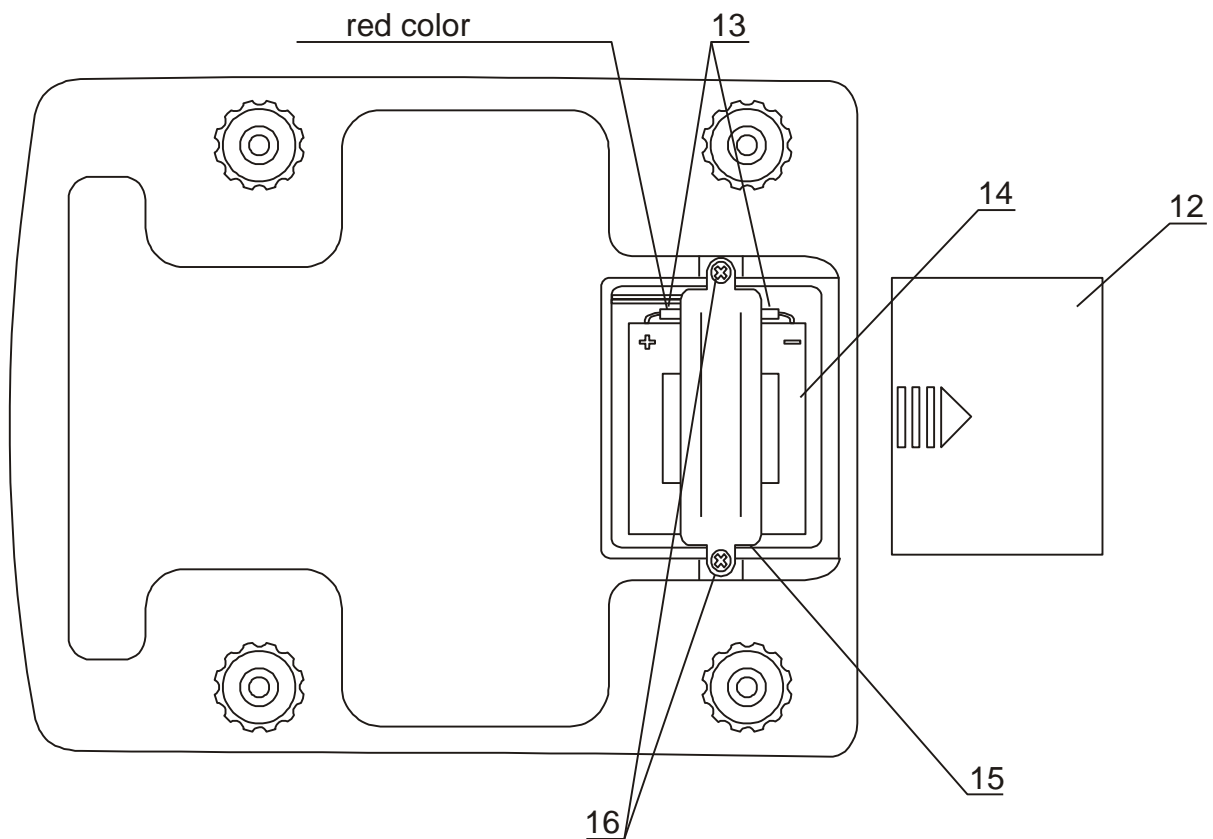

- 3.Remove the cover 12.
- 4.Unscrew tab bolts 16, remove accumulator clamp 15, remove sleeves 13 , remove used accumulator 14.
- 5.Sleeves 13 put on new accumulator 14 , check the polarization (on accumulator + indicated by red color put sleeve with red color).
- 6.Arrange accumulator, put accumulator clamp 15 and screw bolts 16 .
- 7.Put on cover 12.
- 8.Invert the scale.
- 9.Put on pan carefully.

12. Start of work

Leave the pan empty, plug the feeder to the mains (~230V/50Hz) and plug the feeder connector to the 12V power socket at the bottom side of the scale.

Scale will execute following step:

- display type of scale and version of program,
- zeroing the indication.

After displaying an indication on the upper display section scale is ready to work.

13. Pieces counting (PCS)

Scale enables to count identical pieces, e.g. turnbuckles or buttons.

Measurement with unitary weight calculated from given sample:

A measurement is performed in two phases:

- first phase - single piece weight calculation on the basis of defined pieces amount (default is 10 pieces.),
- second phase – pieces counting

1. Put on pan quantified details sample.
2. Turn on pieces counting by pressing →PCS+ key.



3. Place 10 then press Enter communicate will appear. If the quantified sample consists 10 pieces press ENTER. If amount of detail is other write correct value by using numeric keys and press ENTER.
4. Number of details is displayed on lower section of display with PCS indicator. A single piece mass is displayed in middle section with APW indicator.
5. Remove sample form pan and put a portion of pieces to count.
6. Result of calculation is read from lower section display.

Measurement with single pieces removing from pan:

A measurement is performed in two phases:

- first phase - single piece weight calculation on the basic of removed pieces (default is 10 pieces),
- second phase – recalculating pieces in weighting portion.



1. Turn pieces counting by pressing **→PCS-** key.
2. *Place total then* press **Enter** communicate will appear. Put on the pan container with details portion to count and press **ENTER**.

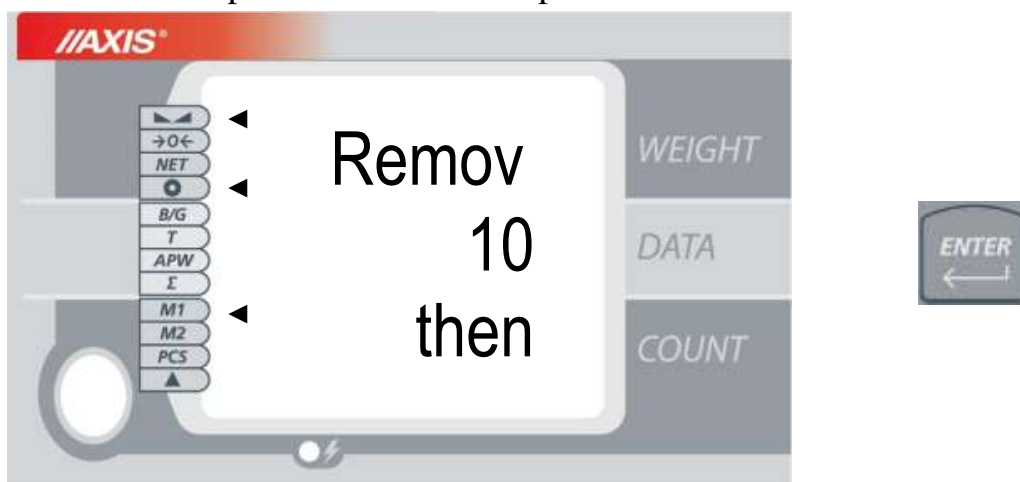

3. *Remove 10 then* press **Enter** communicate will appear. Remove one or more details from the portion.
4. If ten details is removed press **ENTER** key. If amount of removed pieces is other write correct value by using numeric keys and then press **ENTER**.
5. Number of details has been showed on lower section display with **PCS** indicator. A sample mass has been showed in middle section display with **APW** indication.
6. Result of calculation is read from lower section display.

Turning off pieces counting option is possible by holding **→PCS+** or **→PCS-** key and releasing it when **PCSoFF** displays.

Change/write a unitary mass using numeric keys:

During pieces counting (indicator *PCS*) user can change actual sample mass. Writing a sample mass when counting process is turned-off initiates counting process.

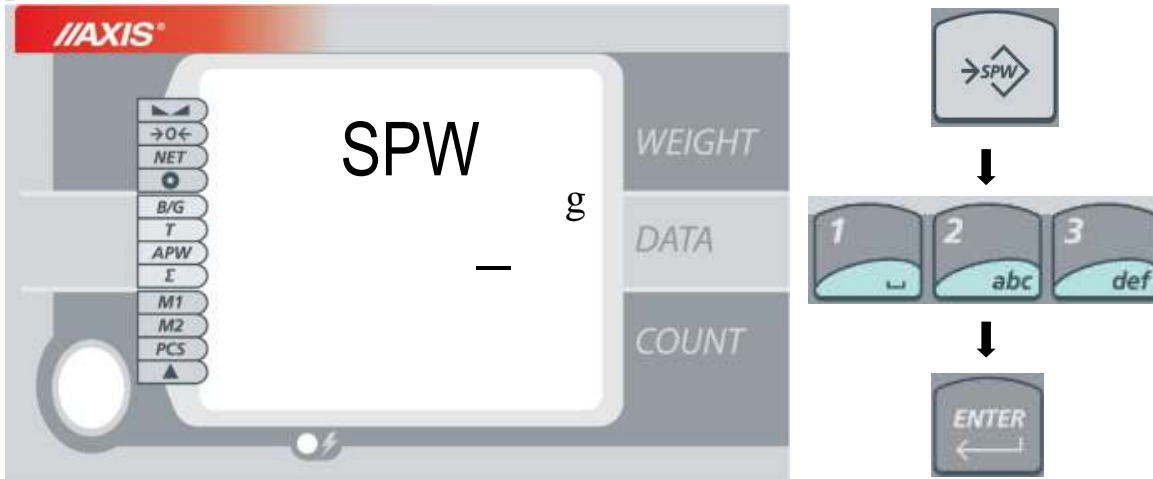

1. Press $\rightarrow SPW$ key.
2. Write sample mass using *numeric keys* and press **ENTER**.
3. Number of details is displayed on lower display section with *PCS* indicator. A unitary mass is displayed in middle display section with *APW* indicator. The upper display section displays sample mass.
4. Result of calculation is read from lower display.

Note:

1. It is advised that single piece weight is not less than one reading unit and sample weight used in first phase is bigger than 100 reading units.
2. If the unit mass (*APW*) is smaller than scale readout unit but bigger than 1/10 of readout unit, a *APW LOW* communicate appears and the counting result blinks. If the unit mass is smaller than 1/10 of readout unit, *APW to LOW* communicate appears and pieces counting is disabled.

14. Summation of measurements series (Σ .)

Scale is equipped with summation register. The register enables adding successive results of measurements.

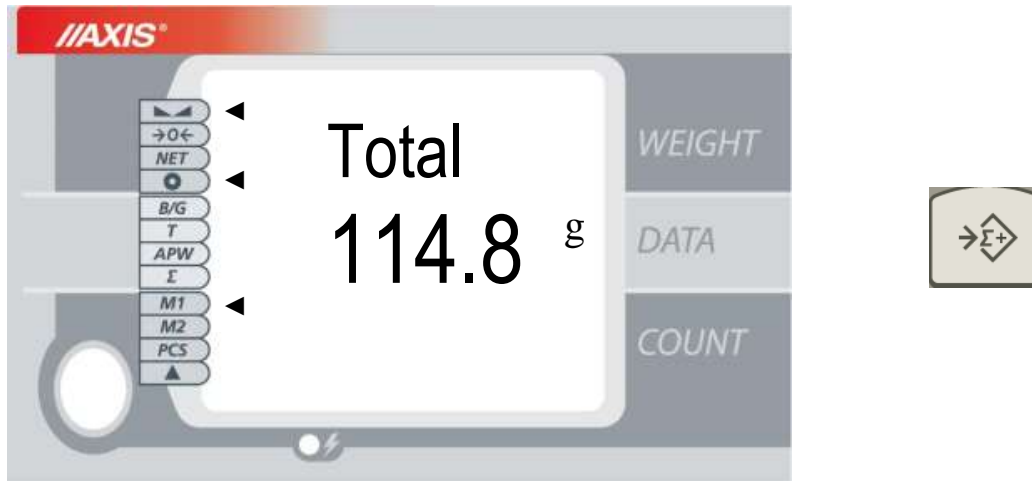

1. Put weighted element on the pan and press $\rightarrow\Sigma+$ button. Contents of this register have been showed temporary in middle section display, the upper section displays *Total* sign.

Note: Using a $\rightarrow\Sigma-$ key causes subtraction of actual measurement from the register.

2. Press several times **DATA** key for continuous displaying of register value – in this case an indicator is turn-on.

Hold $\rightarrow\Sigma+$ or $\rightarrow\Sigma-$ key for more options:

- *View* – viewing summing register value; pressing $\rightarrow\Sigma+$ or $\rightarrow\Sigma-$ key again will cause displaying average value and measurements quantity,
- *Print* – report printout,
- *Reset* – reset summing register,
- *Auto/Manual* – switching working mode to automatic or manual.

We choose option by releasing chosen key ($\rightarrow\Sigma+$ or $\rightarrow\Sigma-$) when proper option is displayed.

15. Permanent tare memory (→PT)

The scale can store up to 10 tare values in memory that can be later recalled. The option enables gross weight measurement (pieces quantity) of product in for eg. container of known weight, and then readout of calculated net weight (pieces quantity).

1. To save permanent tare value into memory put object (eg. empty container) on pan and press →PT. Below screen will be displayed:



2. In lower section display successive tare memory numbers will appear from *tare 1* to *tare 10*. By using **ENTER** key user can select proper tare memory number, where actual weight value is saved.

To recall saved earlier tare value press and hold →PT. Successive tare numbers and their values will display. Releasing →PT key chooses actually displayed tare.

16. Products data library (↔MEM key)

The scale is equipped with data library where user can save 1000 details.

Products base consists of:

- *M no* - record number (M0001÷1000), needed to recall to it,
- *M Id* – product code, inscribed by using keyboard or scanner,
- *APW* – product unit mass, used for pieces counting,
- *SAMPL* – inscribing quantity of products, above which counting results correction algorithm turns on,
- *PtArE* – inscribing constant tare for product (not necessary),
- *thr Lo* – lower threshold value (not necessary),
- *thr Hi* – upper threshold value (not necessary),
- *thr Zr* - zero threshold value (not necessary).

During scale work, barcode reader readout of record number causes searching through scale product library and in case of finding the right record recalling to single piece mass and other product data.

Database can be built in Excel datasheet form, where each product has one row and each column have product data. This way created database, saved in *.csv extension with semicolons can be send to scale using *Scale Database* software and scale's serial interface. *Scale Database* is available on our webpage www.axis.pl/en.

Handy products banks

The scale is equipped with two handy detail banks: M1 and M2, that are related to fast choice keys M01÷M15 and **M16÷M30**. Each key recalls proper number record. Switching between handy detail banks is done by pressing MEM1/**MEM2** key (indicator on lower section display changes position from *M1* to *M2* or vice versa signaling which bank is used at the moment).



fast choice keys



memory switch



indicator on M1 position

Longer pressing one of the fast choice keys causes displaying chosen parameter edition menu.

Short key pressing recalls chosen record.

Products data edition (records)

Products data can be edited by holding chosen fast choice key or by using \leftrightarrow MEM key and inscribing record number.

Longer pressing of \leftrightarrow MEM key causes record number inscribing screen displaying.

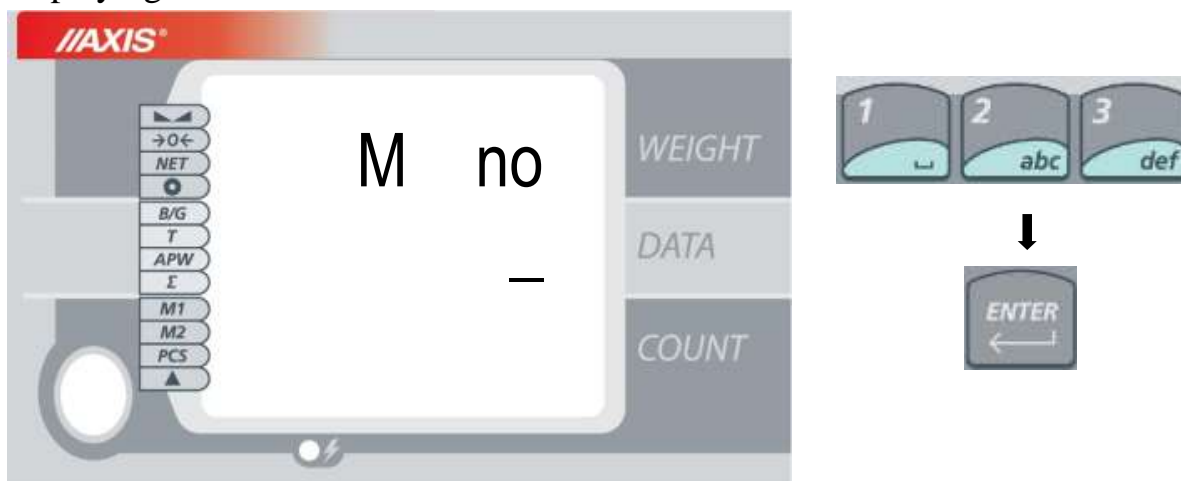

On upper section display *M no* sign shows up and on the middle section a field to inscribe record number (from 1 to 1000). Inscribe the number using numerical keys and confirm by pressing **ENTER**.

Chosen record number will show up on the upper display. On the middle one following options will be successively displayed:

- *M id* – product number inscribing (using balance keyboard or barcode scanner),
- *APW* – single piece mass,
- *SAMPL* – inscribing quantity of products, above which counting results correction algorithm turns on,
- *PtArE* – inserting constant (permanent) tare value for the detail,
- *thr Lo* – lower threshold value ,
- *thr Hi* – upper threshold value,
- *thr Zr* – zero threshold value,
- *SAVE* – saving settings,
- out – exit (user can also use **CLR** key).

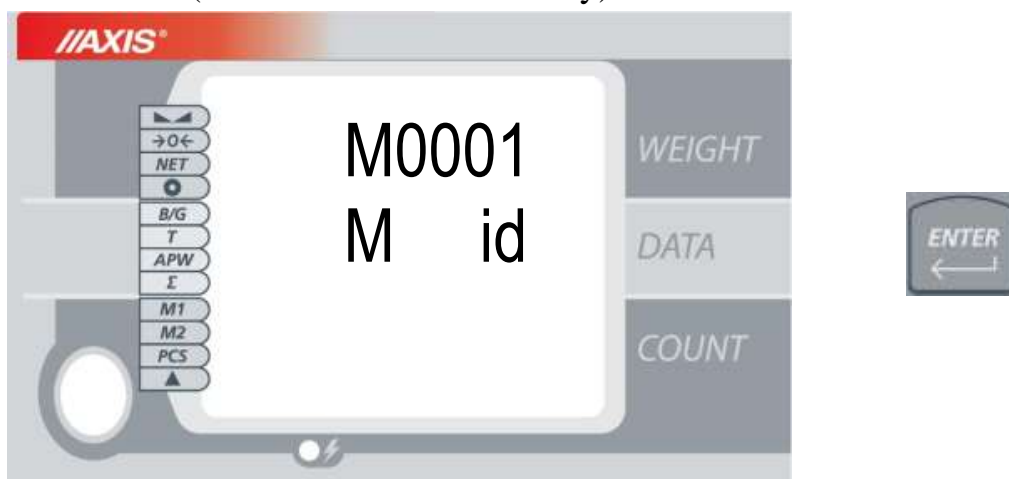

To speed up options displaying user can press $\Sigma+$, $\Sigma-$ or $\rightarrow 0 \leftarrow$ button.

To choose option press **ENTER** key.

After choosing the proper option user can insert numerical value using keyboard and confirm it with **ENTER** key.

Recalling record

Short pressing of \leftrightarrow **MEM** key enables to inscribe record number (earlier edited and saved), which we want to recall.

We inscribe number using numerical keys and confirm using **ENTER** key.

Choosing empty record is signaled by „EMPtY” communicate on middle section screen and a sound signal. To cancel press **CLR** key.

17. Connecting to computer or printer

The scale is equipped with RS232C which can be used to connect external devices such as a computer or a printer

When cooperating with a computer data is send after initiate signal from a computer or after a press  button.

When cooperating with the scale, a computer should be equipped with a program which enables processing data from the scale

The Axis company offers programs to cooperating with scales. These programs are available on site www.axis.pl :

- *Test RS232C*- program to tests serial connections (full version),
- *ProCell* – program enabling cooperation with Microsoft Excel or different Windows applications (demo version).

Information for programmers (transmission protocol describe)

Signal description:

Computer→Scale: initialising signal S I CR LF (53h 49h 0Dh 0Ah),

Scale→Computer: weighing result according to the diagram below

(16Bytes, transmission parameters: 8bits, 1stop, no parity, 4800bps),

Byte description:

Byte 1 -sign „-” or space

" 2 - space

" 3÷4 - digit or space

" 5÷9 - digit, decimal dot or space

" 10 - digit

" 11 - space

" 12 - k, l, c, p or space

" 13 - g, b, t, c or %

" 14 - space

" 15 - CR

" 16 - LF

Connecting cable WK-1 (connect scale with computer / interface 9-pin):

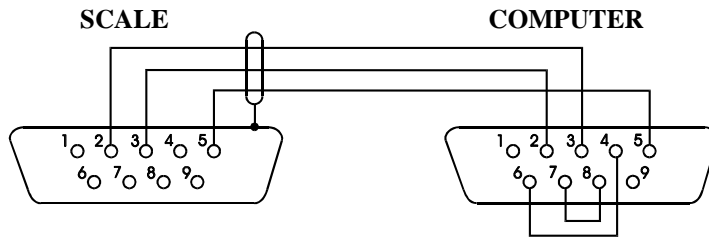

Connecting cable WD-1 (connect scale with printer KAFKA):

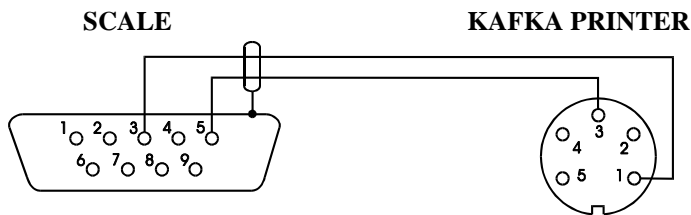

Settings og internal switch printer AXIS:

SW-1	SW-2	SW-3	SW-4	SW-5	SW-6	SW-7	SW-8
on	off	on	off	off	on	off	off

18. Basic function description

18.1 Zeroing scale indication

If the scale pan is unloaded and weight indication is other than zero, press →T← key.

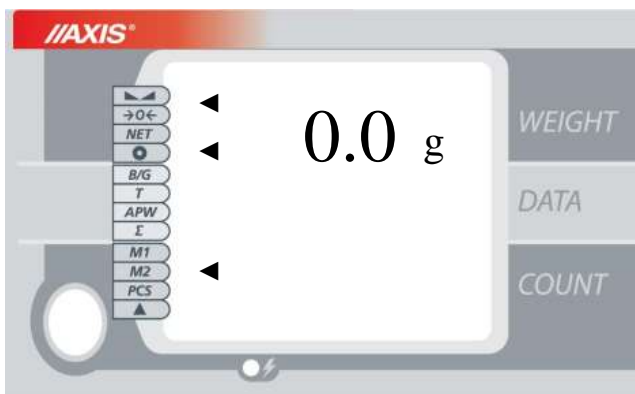
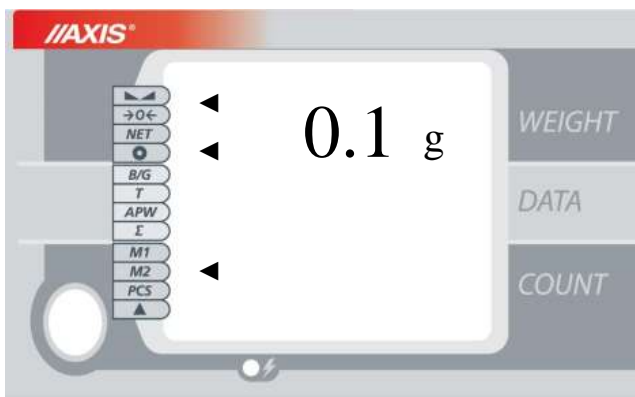

18.2 Tare

Scale enables to tare (zeroing the scale when there is a package on the pan) in whole measurement range. Total tare and net weight value cannot exceed scale's range (Max).

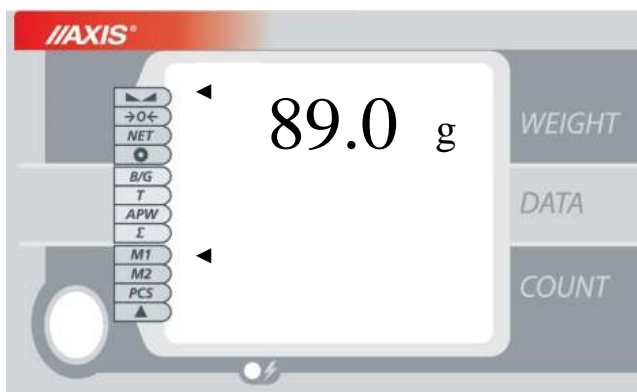
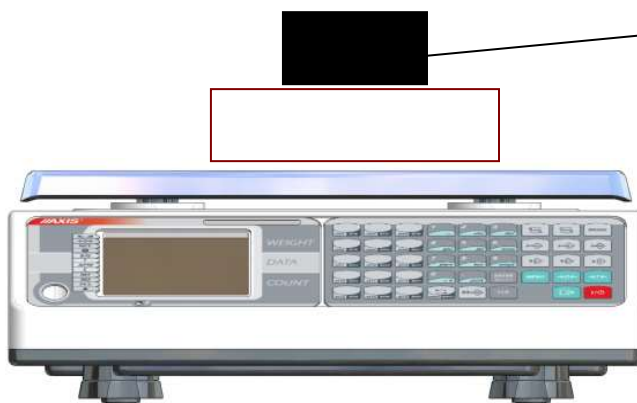
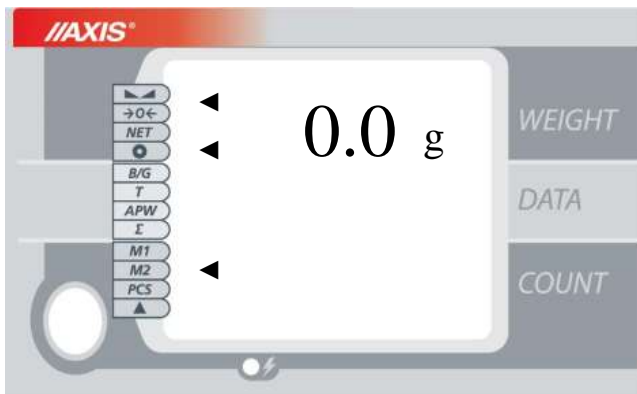
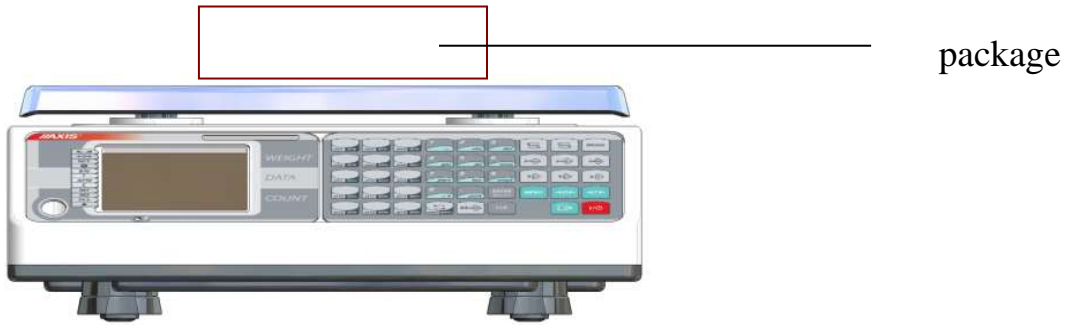

19. User menu

Pressing MENU key enables to use many options, special functions and scale configuration. Option names show up successively in upper section display. To choose displayed option press **ENTER** key.

- PCS

- SAMPL view and edition of default sample quantity; inscribing new value using numerical keys and confirmation by **ENTER** key,
- APA turning on (On) or off (OFF) automatic pieces counting correction function,
- rS SPL Downloading unitary mass using serial port (PORT_1) after earlier inscribing sample quantity; successive operation leads to initiation of pieces counting.

- UnIt

- KGrAM choosing kilogram as default unit after the scale is turned on,
- Pound choosing pound as default unit after the scale is turned on,
- GrAM choosing gram as default unit after the scale is turned on.

Using **UNITS** key changes actually displayed unit.

- PtArE

- tArE 1 view/edition of constant tare nr 1,
- tArE 2 view/edition of constant tare nr 2,
- tArE 3 view/edition of constant tare nr 3,
- tArE 4 view/edition of constant tare nr 4,
- tArE 5 view/edition of constant tare nr 5,
- tArE 6 view/edition of constant tare nr 6,
- tArE 7 view/edition of constant tare nr 7,
- tArE 8 view/edition of constant tare nr 8,
- tArE 9 view/edition of constant tare nr 9,
- tArE 10 view/edition of constant tare nr 10,

After choosing constant tare number a new value can be inscribed using numerical keys and **ENTER** key confirmation.

- totAL

ModE totAL register measurement confirmation mode:
 manual (MAnUA) –after pressing Σ key,
 automatic (Auto) – after indication stabilization,
 PrInt totAL work with (On) printout or without (OFF),
 SAVE totAL summing register saved to non-volatile memory (On) or reset
 after each turning off the scale (OFF).

- thr

Function allows for comparing weighing result with two programmed thresholds values P1 (Lo -lower) and P2 (Hi - upper). Comparing result is signaled by *Lo*, *Ready* or *Hi* marks on display.

oFF threshold function off,
 on threshold function on (run), threshold values edition
 (SEt Lo, SEt HI, SEt Zr),
 PrInt threshold values printout,
 ModE threshold function work mode: net mass (MASS) or pieces quantity
 (PCS),
 outPut transoptors out working mode:
 standard impulse (IMPULS) or signalizator (SIGnAL)

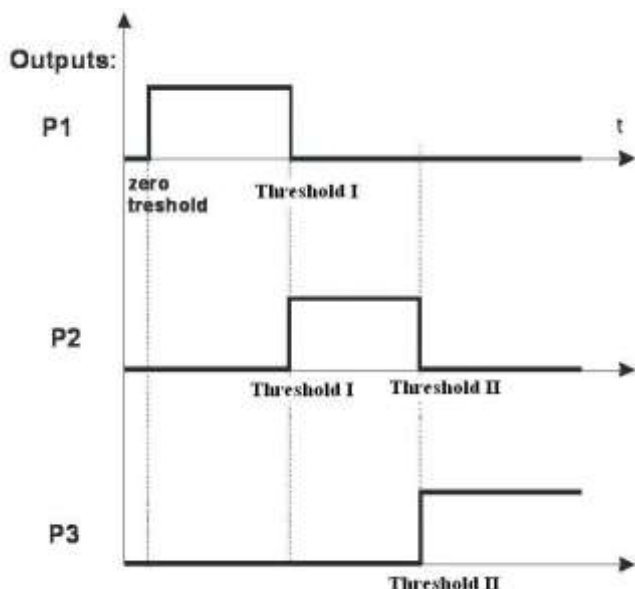
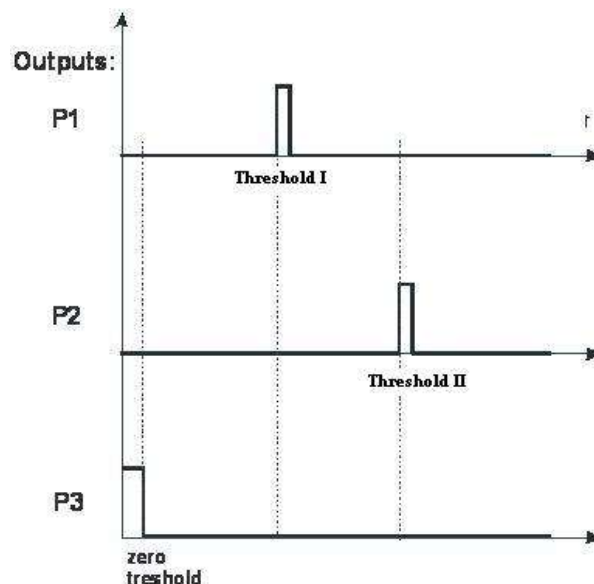
mode *SIGNAL* .:mode *IMPULS*:

If the scale is additionally equipped with *Relays* socket (option) in *IMPULS* mode on outputs P1 (threshold I) and P2 (threshold II) short-circuit impulses appear for about 0,5s. On output P3 (zero) short-circuit state appears with the zero threshold indication.

Relays connection diagram:

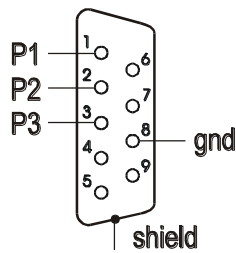

Relays output is the open collector transistor output with load capacity 25mA / 24V.

It is advised to use MS3K/P electronic board (sold separately), consisting of RM96P transmitters, with DC24V input voltage and AC250V, 3A output.

Important notes:

1. After switching the scale on, both thresholds are set to maximum values.
2. When setting upper threshold value, pay attention that its value is not below lower threshold value.
3. Setting lower and upper threshold value is possible after sending appropriate orders from computer, what is described in scale user manual.

- dAtA_b

EdIt inscribing number/code (MODE key switches) of the part to edit,
dELOnE inscribing number/code (MODE key switches) parts to delete,
 confirmation YES/no,
dELALL deleting all parts, confirmation YES/no.

Products edition enables to define:

- PA Id – detail number inscribing,
- APW – unitary mass,
- SAMPL – default sample quantity,
- PtArE – inscribing constant tare to detail,
- thr Lo – low threshold value,
- thr Hi – upper threshold value,
- thr Zr – zero threshold value,
- SAVE – saving settings.

- USErS

Id 1 view/edition user identifier 1,
Id 2 view/edition user identifier 2,
Id 3 view/edition user identifier 3,
Id 4 view/edition user identifier 4,

Id 5 view/edition user identifier 5.

- SEtuP

AutotA turning on (On) or off (OFF) autotare,

CALib scale calibration (available in not veriflicated scales):

Following options will appear:

-CAL on – calibration without successive steps confirmation,

-CAL StP – calibration with successive steps confirmation,

out – exit from calibration.

Press ENTER key when CAL StP is displayed. Inscribe (confirm using ENTER) standard of mass value that will be used for calibration.

Wait until scale zero inscribes (if CAL StP option is chosen press MENU key when PrESS MENU communicate appears).

After LOAD communicate appears put standard of mass (if CAL StP option is chosen press MENU key when PrESS MENU communicate appears).

SErIAL Port-1 and Port-2 serial parameters :

- transmission speed (*bAud*): 1200, 2400 4800, 9600, 19200, 38400, 57600bps,

- quantity of bits in byte (*bitS*): 7, 8,

- parity control (*ParItY*):

none – no control,

Odd – non-parity,

Even - parity,

- continous transmission (*Send*):

oFF – transmission off,

StAb – transmission after pressing  key and indication stabilization,

noStAb – transmission after pressing  without stabilization,

Auto – after putting on and taking off the product without pressing ,

Cont. - about 10 results per second,

ReMOV – transmission after taking off the product from the pan.

- Transmission protocol (*Prot*):

LonG - printer, computer

Eltron – label printer (activates *LAbEL* option),

Pen-01 – pendrive PEN-01 attachment.

- Port-1 and Port-2 printouts configurations (*Print*):

HEAdEr – header: name, model and scale nr,

USEr id – user id (max 6 digits),

Prn no – printout successive number (choosing this options resets the counter),

M id – product number,

dAtE –date (option),

tIME – time (option),

Count – counting result,

-
- APW* – unitary mass,
netto – net weight,
tArE – actual tare value,
brutto – gross weight,
totAL – results sum,
nr LCD – printout nr and measurement result displayed in one line.
- Sound turning on (On) or off (OFF) the sound.
- FILtEr turning on (-10, -20, -30, -40) or off (OFF) additional filters; filter reduces the impact of mechanical vibrations on measurement result.
- b_LIGH backlighting settings:
- *OFF* – backlight off,
- *On* – backlight on,
- *ECO* – turning off after 30s without any actions (no load change or using keys),
- *bAtt* – as above but only when supplied from accumulators.
- rESOLU turning on (LO) or off (HI) scale’s decreasing resolution option.
- bAttEr setting accumulator:
- *OFF* – charging accumulator turned off,
- *On* – charging accumulator on,
- *LEVEL* – charging status readout in %.
- AutoOF scale automatic off function settings:
- *OFF* – scale doesn’t turn off,
- *ON* – scale turns off after 5 minutes without actions (no load change or using keys),
- *bAtt* – as above but only when supplied from accumulators.
- FirMW firmware actualization (service),
dEFAUL default settings

Maintenance and repairs of small defects

1. The scale should be kept clean.
2. Take care that no dirt gets between the platform and the scale base. If found any, remove the pan (lift it up), remove dirt and then replace the pan.
3. In case of improper operation caused by short-lasting power supply decay, unplug the scale from the mains and then plug it again after few seconds.
4. It is forbidden to make any repairs by unauthorised persons.
5. To repair the scale, please contact our nearest service. List of authorized services is shown on site: www.axis.pl.
6. Damaged scales should be sent to repair in original package only. Scale should be protected against pressure.

Error communicates:

Communicate	Possible cause	Remedy
<i>C-1 ... 6</i> (over 1 min.)	self test failed	if displayed more than 1 minute, contact an authorised service
balance doesn't work	protection rod	remove protection rod and cap
<i>L</i>	pan missing	put the pan on
	mechanical damage	contact an authorized service
<i>H</i>	overloading	remove the load from the pan
	mechanical damage	contact an authorized service
<i>Err-b</i>	the scale was switched on with loaded pan	remove the load from the pan
 indicator does not appear	unstable ground vibrations air flows	place the balance on a stable ground not affected by mechanical vibrations and airflows
	balance damage	contact an authorized service
- - - - -	taring is progress	contact an authorized service

Notes