













ATS and BTS series



- high accuracy
- convenient text menu
- displaying drying graph
- storing 20 drying programs
- RS232C and USB interface for printer and computer
- auto and time mode

ATS and BTS series moisture analyzers are used for fast and precise determining of material sample humidity.

 external calibration	 date/time	 unit selection
 GLP compatibility	 printout config.	 drying graph
	 drying programs memory	 drying profiles
	 result in percentage	 drying report
	 multilanguage	 freeware computer program

Options on demand:

- external calibration thermometer
- single use pans set (10 pcs)
- paper filters set (100pcs)
- glass filters set (100pcs)
- dedicated computer software: Promas **freeware**



external calibration thermometer

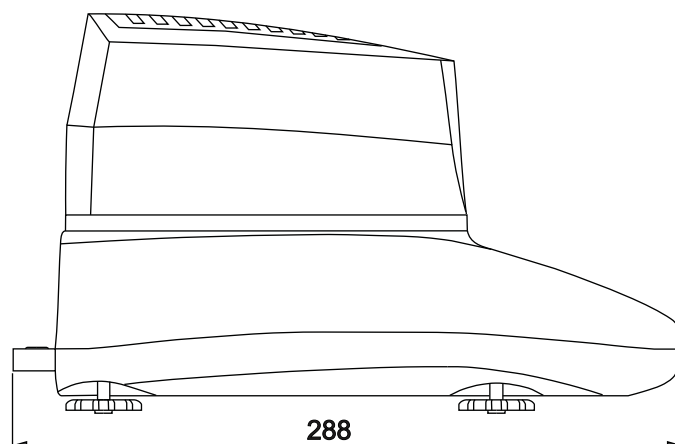
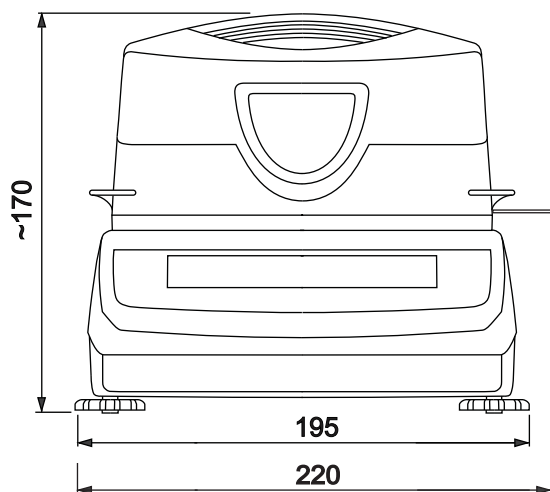

Technical data

Model	ATS60	ATS120	ATS210	BTS110D	BTS110
Range (Max)	60g	120g	210g	110g	110g
Balance readout (d)	1mg	1mg	1mg	5mg	10mg
Recommended sample weight	2÷10g				
Work temperature	+10 ÷ +40°C				
Density readout precision	1% (sample 0,02÷0,5g) 0,1% (sample 0,5÷5g) 0,01% (sample >5g)	1% (sample 0,02÷2,5g) 0,1% (sample 2,5÷25g) 0,01% (sample >25g)		1% (sample 0,02÷5g) 0,1% (sample 5÷50g) 0,01% (sample >50g)	
Humidity measurement repeatability	±0,1% (sample 2g) ±0,04% (sample 5g)	±0,5% (sample 2g) ±0,2% (sample 5g)		±1% (sample 2g) ±0,4% (sample 5g)	
Settings memory	20 drying programs (for 20 different materials)				
Maximal drying temperature	160°C				
Sample time	1 ÷ 180s				
Maximal drying time	10h				
Drying mode	time, short (auto)				
Halogen radiators	2 x 100W 78mm				
Drying chamber heating time up to 100°C	~ 3 min.				
Pan dimensions	90mm				
Drying chamber dimensions	108 x 20mm				
Connections	RS232C (for computer and printer), USB (for computer), PS2 (for computer keyboard)				
Supply	~230V 50/60Hz 230VA				
Dimensions	185 x 290 x 170mm				
Weight	3,9kg			2,8kg	
Recommended calibration weight (OIML)	F2 50g	F2 100g	F2 200g	F2 100g	F2 100g