

# INSTRUCTION MANUAL



## Ozone generator GO 24 / GO 48

**Warning:**

**Read and understand manual before using**



Manufacturer

**POL-EKO-APARATURA**

Manual version 1.2

Date 13.07.2020

## **CONTENTS**

<b>1. ENVIRONMENT PROTECTION AND EQUIPMENT DISPOSAL.....</b>	<b>3</b>
<b>2. SAFETY INSTRUCTIONS.....</b>	<b>3</b>
<b>3. OZONATION PROCESS.....</b>	<b>3</b>
<b>4. PRINCIPLE OF OPERATION.....</b>	<b>4</b>
<b>5. TIMER PROGRAMING MANUAL.....</b>	<b>6</b>
<b>6. NAME PLATE.....</b>	<b>8</b>
<b>7. TECHNICAL DATA .....</b>	<b>9</b>
<b>8. WARRANTY CONDITIONS.....</b>	<b>11</b>
<b>9. DECLARATION OF CONFORMITY .....</b>	<b>11</b>

## 1. ENVIRONMENT PROTECTION AND EQUIPMENT DISPOSAL

The packaging protects the device against damage during transport. The materials from which the device packaging was made are harmless to the environment and are suitable for recycling, therefore they must be disposed of in a manner consistent with the principles of environmental protection. The product you purchased was also made of materials that are suitable for recycling after use.

The product is marked in accordance with the European regulations on waste electrical and electronic equipment (WEEE2).

### **Protect the environment we all live!**

We would like to inform you that we have made every effort to meet your expectations and work reliably for as long as possible. We will be very grateful for any suggestions related to the functioning of the device - they will allow us to further improve their work! Please visit our website [www.pol-eko.com.pl](http://www.pol-eko.com.pl)

## 2. SAFETY INSTRUCTIONS

1. The device is powered by AC 230V / 50Hz - 60Hz. To avoid electric shock, in the event of a device malfunction, connect it to a power outlet equipped with a protective pin (grounding).
2. When the device is not in use, disconnect the power plug from the power socket.
3. The ozonator is designed to work indoors. Do not use it near water or in a high humidity environment.
4. The device should be placed at a minimum distance of 15 cm from a wall or other object, only then is sufficient air flow through the housing guaranteed.
5. Do not place the generator near heat sources.
6. Do not interfere with the airflow by covering the fan's ventilation grille and the opposite outlet grilles.
7. Due to the fact that there is high voltage inside the enclosure, do not open it or allow objects or liquids to enter. It may cause electric shock or fire.
8. The generator cannot be used in rooms with flammable materials, near flammable sprays and open flames.
9. Keep the device out of the reach of children.

## 3. OZONATION PROCESS

1. The surface on which the device is placed should be stable, dry and clean. Do not place it on carpets, rugs etc.
2. The generator should be placed on a platform, the higher it is set, the more efficient its work will be. This is due to the fact that ozone is heavier than air and falls down.
3. The device should be used in a horizontal position with the handle (device handle) facing up.
4. During the ozonation process, devices forcing mechanical airflow must be turned off and the ventilation grilles sealed. There must be no people or animals in the room. It is also recommended to take plants out of the room. Electronic devices and other items made of ozone-sensitive materials (e.g. oil paintings) should be removed or sealed (e.g. with foil).
5. "No entry" sign should be placed on the door of the ozonated room, eg, "NO ENTRY - OZONE DISINFECTION".
6. If it is necessary to enter the room during ozonation, wear protective clothing and an inhalation mask with a suitable cartridge, and stay in the room for as short a time as possible.
7. After the ozonation process, wait 20 minutes, and then enter the room in the inhalation mask and ventilate it well.

**The room can be used 2 hours after the end of ozonation.**

## 4. PRINCIPLE OF OPERATION

The ozonator, also called the ozone generator, is a device for producing ozone. It is extremely useful for cleaning and refreshing the air. The ozone generated by the device fights all sorts of unwanted microorganisms in our environment. Removes impurities, has strong virucidal, bactericidal and fungicidal properties. In addition, the ozone generator effectively removes any unpleasant odors, completely neutralizes them.

Ozonator, through electrical discharges on ceramic tiles, using oxygen contained in the air, it produces ozone. Ozone is an allotropic form of oxygen, consisting of triatomic molecules. Has strong aseptic properties. Unlike oxygen, it is an unstable gas. Its half-life

in the air does not exceed 40 min (depends, among others, on the degree of air pollution and temperature). After about 2 hours, the ozone produced is converted back to diatomic oxygen molecules (O<sub>2</sub>).

**Table 1. Ozonation time selection**

Examples of ozonation times by room volume and generator model				
Time [min]	GO24		GO48	
	Refreshing with removal of unpleasant odors [m3]	Disinfection [m3]	Refreshing with removal of unpleasant odors [m3]	Disinfection [m3]
10	50	25	80	40
20	110	55	220	110
30	170	85	380	190
40	220	110	540	270
50	270	135	700	350
60	330	165	840	420

The values given in the above table have been experimentally determined for an ambient temperature of 20°C. In the case of generator operation in rooms with an ambient temperature exceeding 24°C, it is recommended to extend the ozonation time by 1/3 of the value given in the table above, not exceeding the maximum operating time of 90 minutes. The increase in time is related to the fact that the half-life of ozone decreases with increasing ambient temperature.

In rooms with a cubature of over 80m<sup>3</sup>, it is recommended to use an additional fan forcing air circulation in the ozonated room. Place the fan according to posted drawing.

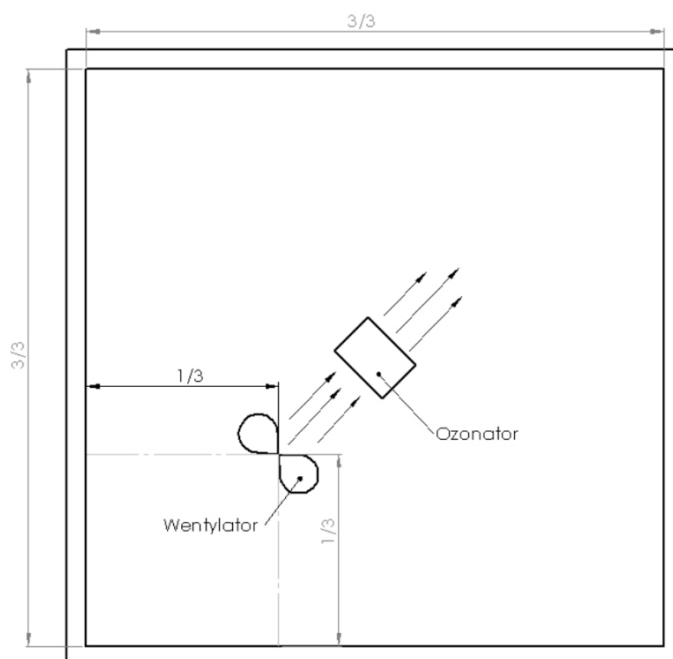

## 5. TIMER PROGRAMING MANUAL

After turning on the device, the last saved settings will appear on the screen. The device is factory set to work for 20 minutes after switching on.

Do not exceed 60 minutes of continuous operation of the device. When using the device for longer than the factory-set 20 minutes of operation, leave the device to rest for a minimum of 20 minutes after the completed cycle.









During the ozone generation process on the time controller display (in case of version 2 of the controller, on the lower display) the time will be counting till end of working cycle.

During operation the ozone generator generate a characteristic sound (buzzing) and the fan can be heard. After the set operating time has elapsed, the ozone generation process is automatically stopped..

To set the desired operation time:







### CONTROLLER VERSION 1



1. Press the button  for 2 seconds, the seconds value will be flashing. Diode  and T1 will start flashing.
2. With the buttons   set the value of seconds and confirm with . The minutes value will start flashing.
3. With the buttons   set the value of minutes and confirm with . The diodes will stop flashing. From this moment the controller will start counting down the time.
4. To cancel the setting, press the button .

## CONTROLLER VERSION 2



1. Press the SET button . The value on the upper display (red) will flash.
2. Set the desired delay time for starting the ozone generator (default 1 minute) by using the arrows   
.
3. Press the SET button . The value on the lower display (blue) will flash. Enter the desired operating time (factory setting is 20 minutes) by using the arrows   
.
4. To confirm, press the SET button again .
5. After counting down the time from the upper display, the device starts generating ozone and the time set on the lower display starts counting down.

If there is no response for a period of 6s, the currently entered settings will be automatically saved.

### Factory settings

To restore the device to the factory settings, press the SET button longer until the program code appears on the upper screen, e.g. P0. Use the SET button to switch the view between the following programs: P0-P9. Arrows adjust the values. The Restart button can be used to exit the settings or switch off the device completely.

P0-1: T1 time in minutes

P1-2: Delay for T1 relay switching time (T1 timer) and then releasing the relay after T2 (T2 timing). Then the device ends.

## 6. NAME PLATE

Name plate is located on the left wall of the device in the upper left corner:

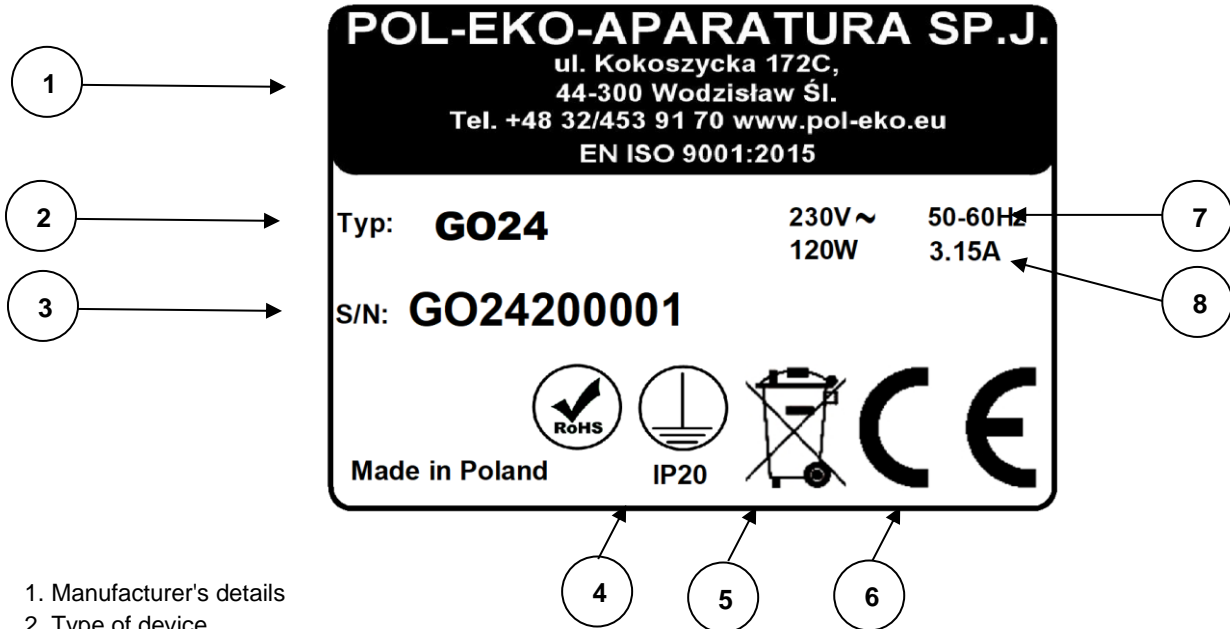

1. Manufacturer's details
2. Type of device
3. Serial number
4. Degree of protection against electric shock (Class I: protection against indirect contact) and degree of protection of IP housing
5. Designation of the device used according to the WEEE2 directive
6. CE marking as confirmation of compliance with regulations
7. Supply voltage and frequency
8. Rated power, fuse value



## 7. TECHNICAL DATA

<b>TECHNICAL DATA GO 24</b>	
ozone generation efficiency [g/h]	24
fan [m <sup>3</sup> /h]	122
controller	microprocessor
display	LED
housing	polished stainless steel, X5CrNi18-10
handle material/materiał uchwytu	plastic
operating temperature	10°C – 40°C
operating humidity	below 80%
declared generator life [h]	1000
<b>DIMENSIONS AND WEIGHT</b>	
width [mm]	201
height with handle [mm]	203
depth [mm]	249

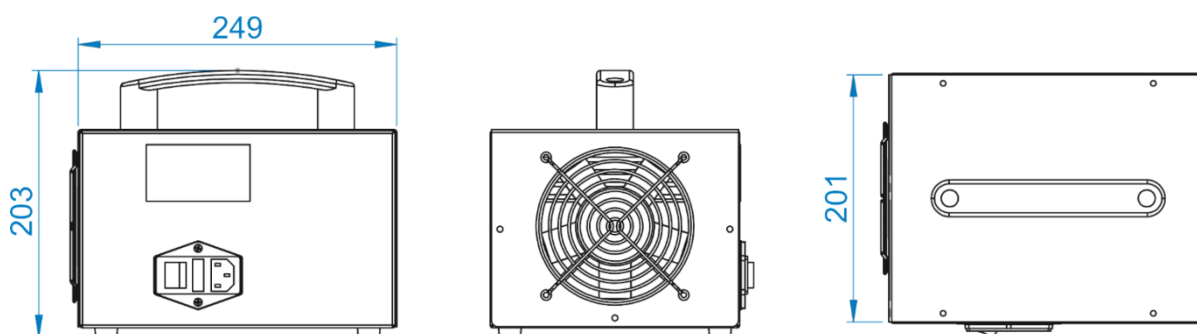

weight [kg]	2
<b>ELECTRICAL PARAMETERS</b>	
power supply	230V 50-60Hz
nominal power [W]	120
cable length [m]	3
warranty	24 months
manufacturer	POL-EKO-APARATURA

**TECHNICAL DATA GO 48**

ozone generation efficiency [g/h]	48
fan [m <sup>3</sup> /h]	344
controller	microprocessor
display	LED
housing	polished stainless steel, X5CrNi18-10
handle materialmateriał uchwytu	plastic
operating temperature	10°C – 40°C
operating humidity	below 80%
declared generator life [h]	1000

**DIMENSIONS AND WEIGHT**

width [mm]	211
height with handle [mm]	223
depth [mm]	313

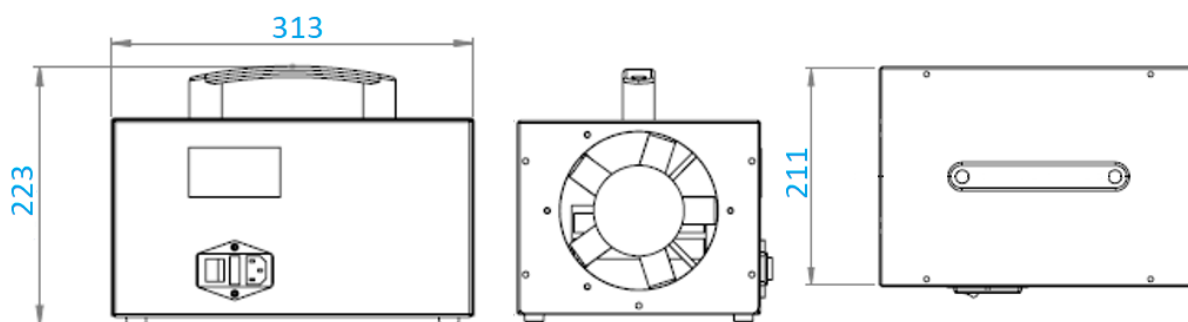

weight [kg]	4
-------------	---

**ELECTRICAL PARAMETERS**

power supply	230V 50-60Hz
nominal power [W]	280
cable length [m]	3
warranty	24 months
manufacturer	POL-EKO-APARATURA

## 8. WARRANTY CONDITIONS

POL-EKO-APARATURA warrants that this product will be free from defects in material and workmanship for a period of two (2) years from date of the invoice. If a defect is present, POL-EKO-APARATURA will, at its option and cost, repair, replace, or refund the purchase price of this product to the customer, provided it is returned during the warranty period. This warranty does not apply if the product has been damaged by accident, abuse, misuse, or misapplication, or from ordinary wear and tear. If the required maintenance and inspection services are not performed according to the manuals and any local regulations, such warranty turns invalid.

The device that is being returned must be secured by the customer in the event of any damage or loss. The warranty will be only limited to the situations listed above. IT IS EXPRESSLY AGREED THAT THIS WARRANTY WILL BE IN LIEU OF ALL WARRANTIES OF FITNESS AND IN LIEU OF THE WARRANTY OF MERCHANTABILITY.

All complaints should be reported to the following address:

**POL-EKO-APARATURA Sp.j.**  
**ul. Kokoszycka 172 C, 44-300 Wodzisław Śl.**  
**Tel: +48 / 32 453 91 96, 32 453 91 70, 32 453 90 30**  
**E-mail: [serwis@pol-eko.com.pl](mailto:serwis@pol-eko.com.pl)**



Support form and warranty conditions are specified on the manufacturer's website:

<http://www.pol-eko.com.pl/en/service>

### **Compliance with local laws and regulations**

The user is responsible for obtaining any approvals or authorizations required to launch and use the product. POL-EKO-APARATURA shall not be liable for any negligence in the above matter except when the refusal to obtain authorization is caused by a product defect.

## 9. DECLARATION OF CONFORMITY

 <b>DEKLARACJA ZGODNOŚCI UE</b> <b>EU DECLARATION OF CONFORMITY</b>		
<b>Produkt:</b>	<b>Product:</b>	
Generator ozonu	Ozone generator	
<b>Model:</b>	<b>Model:</b>	
	GO24 GO48	
<b>w wersjach:</b>	<b>in version:</b>	
	-	
<b>Nazwa i adres producenta:</b>	<b>Name and address of the manufacturer:</b>	
	POL-EKO-APARATURA sp.j. A. Polok-Kowalska, S. Kowalski ul. Kokoszycka 172c 44-300 Wodzisław Śl.	
<b>Niniejsza deklaracja zgodności wydana zostaje na wyłączną odpowiedzialność producenta.</b>	<b>This declaration of conformity is issued under the sole responsibility of the manufacturer.</b>	
<b>Wymieniony powyżej przedmiot niniejszej deklaracji jest zgodny z odnośnymi wymaganiami unijnego prawodawstwa harmonizacyjnego:</b>	<b>The object of the declaration described above is in conformity with the relevant Union harmonisation legislation:</b>	
LVD 2014/35/UE EMC 2014/30/UE WEEE 2012/19/UE	LVD 2014/35/EU EMC 2014/30/EU WEEE 2012/19/EU	
<b>Odniesienia do odnośnych norm zharmonizowanych, które zastosowano, lub do innych specyfikacji technicznych, w stosunku, do których deklarowana jest zgodność:</b>	<b>References to the relevant harmonised standards used or references to the other technical specifications in relation to which conformity is declared:</b>	
	PN-EN 60335-1:2012 PN-EN 61010-1:2011 PN-EN 60529:2003/A2:2014-07	
Wodzisław Śl. 05.05.2020	POL-EKO-APARATURA sp.j. DYREKTOR  Sebastian Kowalski (Director)	



Manufacturer of laboratory equipment  
and authorized distributor of:  
WTW, Thermo Scientific, Knick.



**POL-EKO-APARTATURA sp.j.**  
**A. Polok-Kowalska, S. Kowalski**  
**ul. Kokoszycka 172 c, 44-300 Wodzisław Śląski**  
**tel. 32 453 91 70, fax 32 453 91 85**

e-mail: [info@pol-eko.com.pl](mailto:info@pol-eko.com.pl)  
web: <https://www.pol-eko.com.pl/home-en/> \* <https://smart4lab.eu/smart-en/>

**We produce:**

- thermostatic cabinets
- laboratory refrigerators
- laboratory incubators
- devices with photoperiod and phytotron system
- drying ovens and sterilizers
- drying ovens with nitrogen blow
- laboratory freezers
- ultra-low freezers
- climatic chambers
- Caldera fluid and blanket warmers
- colony counters
- laboratory shakers
- stationary samplers
- Hydromat water dispensers
- Eurodrop stations
- FEKO+ waste water receipt station
- heating ovens
- cooled incubators
- Compact lab designing
- fume hoods

**We offer portable, laboratory and on-line equipment:**

- pH-meters
- ionmeters
- dissolved oxygen meters
- conductivity meters
- photometers and spectrophotometers
- thermo reactors
- turbidity metres
- pH electrodes
- conductivity sensors
- oxygen probes
- heavy metals trace analyzers
- water baths
- autoclaves
- pH buffer solutions
- conductivity standards
- photometric tests
- laboratory accessories
- consumables

**We organize:**

- regional trainings
- individual trainings
- seminars

**We provide:**

- warranty and post-warranty service
- consultancy in the selection, maintenance and operation of laboratory equipment

**POL-EKO LAB is Accredited by the Polish Centre for**

**Accreditation (a member of ILAC) and provides accredited calibration of:**

- thermostatic and climatic chambers (incubators, drying ovens, thermostatic cabinets, climatic chambers, freezers)
- water baths and thermo reactors
- autoclaves
- electric and electronic thermometers
- data loggers
- high temperature laboratory furnaces
- thermohygrometers
- laboratory sieves



AP 115

**Calibration is confirmed with the issue of 'Calibration Certificate'.**

**Services outside the scope of accreditation:**

- checking equipment for physicochemical measurements (meters and probes),
- carrying out IQ, OQ, PQ qualification procedures,
- mapping of temperature and humidity in the rooms