

Instruction manual SMART PRO

Thermostatic cabinets

models: ST 1, ST 2, ST 3, ST 4, ST 5, ST 6,
ST 500, ST 700, ST 1200, ST 1450,
ST 500 M, ST 700 M, ST 1200 M, ST 1450 M

Laboratory refrigerators

models: CHL 1, CHL 2, CHL 3, CHL 4, CHL 5, CHL 6,
CHL 500, CHL 700, CHL 1200, CHL 1450
CHL 500 M, CHL 700 M, CHL 1200 M, CHL 1450 M

Multichamber devices

models: ST 1/1, ST 1/1/1, ST 2/2, ST 2/3
CHL 1/1, CHL 1/1/1, CHL 2/2, CHL 2/3
ST1/CHL1, ST2/CHL2, ST2/CHL3

Laboratory incubators

models: ILW 53, ILW 115, ILW 240, ILW 400, ILW 750

Before using the equipment, please read carefully this instruction manual!

Version 1.36

Issued 3.11.2023



Manufacturer's address:

POL-EKO A.Polok-Kowalska sp.k.
ul. Kokoszycka 172 C
44-300 Wodzisław Śląski
Country of origin: Polska

As a manufacturer, we inform you that we took the necessary measures to ensure that this device fully meets your expectations and is reliable for a long period of use. Due to the continuous improvement of our products, as well as the expansion of our offer, any suggestions regarding additional functions and equipment functioning are welcome. Visit our homepage www.pol-eko.com.pl/home-en/

Equipment disposal



















This equipment is marked with the crossed out wheeled bin symbol to indicate that this equipment must not be disposed of with unsorted waste. Instead it's your responsibility to correctly dispose of your equipment at lifecycle -end by handling it over to an authorized facility for separate collection and recycling. It's also your responsibility to decontaminate the equipment in case of biological, chemical and/or radiological contamination, so as to protect from health hazards the persons involved in the disposal and recycling of the equipment. For more information about where you can drop off your waste of equipment, please contact your local dealer from whom you originally purchased this equipment.

By doing so, you will help to conserve natural and environmental resources and you will ensure that your equipment is recycled in a manner that protects human health.

Thank you!

Contents:

1. INTENDED USE AND IMPORTANT INFORMATION FOR THE USER	6
2. PACKAGE CONTENTS	7
3. BEFORE THE FIRST USE	8
3.1. Installation of shelves	10
3.2. Condensation in the chamber	13
3.3. Remarks on the placement of samples.....	13
3.4. Closing chamber door.....	13
3.5. Anchoring of the equipment.....	14
4. DESCRIPTION OF THE DEVICE	15
4.1. Design of ST / CHL devices.....	15
4.2. Design of ILW devices	18
5. DEVICE EQUIPMENT (standard and optional)	20
5.1. Internal glass door (optionally for ST / CHL, standard for ILW).....	20
5.2. External glass door (optionally for ST/CHL).....	20
5.3. External door with viewing window (optionally for ILW)	20
5.4. Internal socket (optionally for ST, CHL, ILW).....	21
5.5. Door lock (standard for ST, CHL, ILW)	21
5.6. Access port for external sensor (standard for ST, CHL, ILW).....	21
5.7. Open door alarm (standard for ST, CHL, ILW)	22
5.8. Internal LED light (standard for ST, CHL, optionally for ILW)	22
5.9. USB port (standard for ST, CHL, ILW).....	22
5.10. Phytotron FIT (optionally for ST and ILW)	23
5.11. Display battery backup (optionally for ST, CHL, ILW).....	24
6. DEVICE OPERATION	25
6.1. External memory (USB flash drive).....	25
6.2. First boot.....	25
6.3. Using the keypad.....	25
6.4. User logging in.....	26
6.5.  Main screen.....	27
6.5.1. Information panel.....	28
6.5.2. The meaning of icons and symbols	30
6.5.3. Upper expandable and configurable menu.....	32
6.5.4.  Quick Note – user’s message	33
6.5.5. Alarm bar	34
6.6. Quick Program.....	34
6.7.  Programs.....	36
6.7.1. Creating / editing a program	37
6.7.2. Segments edition.....	38
6.7.3. Phytotron FIT (optionally for ST and ILW)*.....	40

6.7.4.	Summary of segments.....	43
6.7.5.	Protection class	44
6.7.6.	Temperature protection	44
6.7.7.	Priority	44
6.7.8.	Loop	45
6.7.9.	Defrosting program (only for CHL 1-6, CHL 500, CHL 700, CHL 1200, CHL 1450) ^{1,2}	45
6.8.	Starting the program	46
6.8.1.	The first way	46
6.8.2.	The second way	47
6.9.	Quick change of parameters.....	48
6.9.1.	Quick change of set temperature	49
6.9.2.	Quick change of set time	49
6.9.3.	Quick change of fan efficiency (only for ILW, ST 1-6, CHL 1-6)	50
6.10.	 Schedules	51
6.10.1.	Creating / editing a schedule	52
6.10.2.	Starting a schedule.....	55
6.11.	 Statistics	57
6.12.	 Data record.....	58
6.12.1.	Graph	59
6.12.2.	Data storage directly on a USB flash drive	60
6.13.	 Event log	61
6.14.	 Info	64
6.15.	 Users	65
6.15.1.	Creating / editing a user	65
6.15.2.	Account types and their limits.....	66
6.16.	 User settings panel.....	68
6.16.1.	Unlocking the touch screen	70
6.17.	 Time	70
6.18.	 Alarms	72
6.18.1.	Alarms when set parameters are exceeded	72
6.18.2.	Open door alarm	74
6.18.3.	STM function	74
6.18.4.	 Mute option	76
6.19.	 Network	77
6.20.	 E-mail reports	78
6.21.	 Automatic defrosting function (optionally for ST 1-6, ST 500-1450, CHL 1-6, CHL 500-1450, ILW, standard for ST 500 M-1450 M i CHL 500 M-1450 M)* ¹	80
6.22.	 Temperature – additional temperature sensor Pt 100 (option).....	81

6.23.	 Corrections.....	82
7.	INTERFACE.....	83
7.1.	MODBUS TCP.....	83
8.	TEMPERATURE PROTECTION.....	83
8.1.	Temperature protection class	84
9.	CONNECTING THE DEVICE TO A COMPUTER.....	84
10.	OPERATION OF THE COOLING SYSTEM.....	84
11.	CLEANING AND MAINTENANCE OF THE DEVICE	85
11.1.	Exterior cleaning	85
11.2.	Interior cleaning	85
11.3.	Cleaning the touch screen	89
11.4.	Consumables.....	90
12.	ADVICE ON HOW TO SAFELY STORE THE DEVICE.....	90
13.	TROUBLESHOOTING.....	90
13.1.	Possible defects.....	91
14.	WARRANTY CONDITIONS	92
15.	RATING PLATE.....	93
16.	TECHNICAL DATA.....	94
16.1.	ST, CHL devices.....	94
16.2.	ST M, CHL M devices with monoblock	95
16.3.	ST, CHL multi-chamber devices	96
16.4.	ILW devices	99
17.	DECLARATIONS OF CONFORMITY.....	100





1. INTENDED USE AND IMPORTANT INFORMATION FOR THE USER

ST thermostatic cabinets, CHL refrigerators and ILW cooled incubators are laboratory devices designed for incubation and storage of samples at following temperature ranges:

- thermostatic cabinets ST: +3°C ... +70°C
- laboratory refrigerators CHL: 0°C ... +15°C
- laboratory incubators ILW: -10°C (option)/0°C... +100°C

Thermostatic cabinets and incubators have both heating and cooling systems and forced air convection. Laboratory refrigerators have only a cooling system. All devices are controlled by a precise SMART PRO controller, thanks to which the set temperature is maintained with good fluctuation and variation. ST thermostatic cabinets and CHL refrigerators are also available in multi-chamber versions, in which each chamber is independently controlled - this manual also applies to devices of this type.

The meaning of information symbols

	This symbol means that failure to follow the instructions could endanger people's health or life, or damage the device. The manufacturer is not liable for damages resulting from non-compliance with the instructions contained in the manual.
	A flammable coolant is used in the cooling system. If the cooling system is damaged, ventilate the room carefully and remove all open flames near the unit.
	Warning for devices equipped with UV fluorescent lamps: take special care during work, avoid exposure of the hands and eyes to ultraviolet radiation. This radiation can cause eye damage (conjunctivitis) and skin changes (redness, cancer lesions, etc.). It is recommended not to open the device chamber if UV light is on. The user should be equipped with personal protective equipment (protective gloves, safety glasses).
	This symbol indicates helpful tips.

To guarantee your security and the longevity of the unit, please comply with the following rules:

1.	<u>The unit cannot be installed:</u> <ul style="list-style-type: none"> • outside, • in damp places or places which can be easily flooded, • near flammable or volatile substances, • near acids or in corrosive environments.
2.	<u>It is forbidden to:</u> <ul style="list-style-type: none"> • store inflammable or volatile substances inside the unit, • touch live parts of the unit, • operate the unit with wet hands, • put water vessels on the unit, • climb on the unit, • overload the shelves (the maximum load is described in technical data), • place objects on the bottom of the chamber.
3.	<u>You should:</u> <ul style="list-style-type: none"> • place samples in such a way to provide proper air circulation in the chamber, • open the door for the shortest period of time to reduce temperature fluctuations, • secure samples from being blown out by the chamber fan e.g powdery samples, • always check that the doors are closed correctly, • use only mains with earth to avoid electric shocks,

Instruction manual ST, CHL, ILW SMART PRO

- unplug the power cable holding the protective cover and not the cable itself,
- disconnect the unit from the mains before undertaking any repairs or maintenance work (in order to not lose the warranty during its duration, all repairs should be carried out by an authorized service),
- protect the power cable and the plug from any damage,
- disconnect the power plug before moving the unit,
- disconnect the power plug if the device will not be used for a long period of time,
- disconnect the unit and protect it from reconnecting if it has any visual fault.

Failure to comply with the above recommendations may result in damage to the device or deterioration of technical parameters, as well as loss of warranty.

2. PACKAGE CONTENTS

Thermostatic cabinets (ST) and laboratory refrigerators (CHL) in SMART PRO version are delivered with:

Device	ST/CHL										
	Capacity	1	2	3	4	5	6	500	700	1200	1450
Shelves [pcs.]	2	2	2	3	3	3	3	3	3	6	6
Slides [pcs.]	4	4	4	6	6	6	6	6	6	12	12
Bottom shelves [pcs.]	x	1	1	1	1	1	1	x	x	x	x
Slides for bottom shelves [pcs.]	x	2	2	2	2	2	2	x	x	x	x
Power cord [pcs.]	1	1	1	1	1	1	1	1	1	1	1
Rubber cap [pcs.]	1	1	1	1	1	1	1	1	1	1	1
Key for door lock [pcs.]	2	2	2	2	2	2	2	2	2	4	4
Ethernet cable [pcs.]	1	1	1	1	1	1	1	1	1	1	1
Lab Desk program (in the internal memory of the equipment)	1	1	1	1	1	1	1	1	1	1	1
Wrench (13mm) for wheels adjustment [pcs.]	x	x	x	x	x	x	x	x	x	1	1
Quality Control Certificate [pcs.]	1	1	1	1	1	1	1	1	1	1	1

Cooled incubators (ILW) in SMART PRO version are delivered with:

Device	ILW					
	Capacity	53	115	240	400	750
Shelves [pcs.]	2	2	2	3	3	5
Slides [pcs.]	4	4	4	6	6	10
Power cord [pcs.]	1	1	1	1	1	1
Rubber cap [pcs.]	1	1	1	1	1	1
Key for door lock [pcs.]	2	2	2	2	2	2
Ethernet cable [pcs.]	1	1	1	1	1	1
Lab Desk program (in the internal memory of the equipment)	1	1	1	1	1	1
Wrench (13mm) for wheels adjustment [pcs.]	x	x	x	x	1	1
Quality Control Certificate [pcs.]	1	1	1	1	1	1

3. BEFORE THE FIRST USE

The manufacturer sends the device protected by cardboard profiles and foil. The device **should be transported in an upright position** and the package should be secured against sliding during transport.



After receiving the device, visually assess its condition and equipment in the presence of the person delivering the goods. A courier company is responsible for any damage caused during transport.



While carrying the unit, do not tilt it to one side more than 45° from the upright position, as there is a high probability of damaging the compressor. If it is necessary to tilt it to one side more than 45°, then after placing it, please wait about 3 hours before connecting the unit to the mains.



After transporting the device at a temperature below 10°C, wait at least 2 hours before connecting it to the mains.

On the surface of unit's components made of stainless steel, slight discoloration may occur. It is a result of the technologies used in the production of metal sheet in accordance with the requirements of PN-EN 10088-2 standard and it is not a defect of the unit.

The place of installation of the unit should meet the following conditions:

- ambient temperature +10°C...+28°C, for models with glass door +10°C...+25°C,
- recommended relative humidity of the ambient air up to 60%,
- the unit has not been designed to work in highly dusty environments,
- ensure proper ventilation in the room,
- the device should be placed on a hard and stable surface,
- the unit should be placed at least 100mm away from the walls,
- the height of the room must be at least 300mm greater than the height of the unit,
- the unit is not designed to be built-in,
- the place of installation of the device should be equipped with a socket with parameters suitable for the device.

If you don't comply with the above recommendations, the unit may get broken or it may worsen the technical parameters such as:

- **temperature fluctuation,**
- **temperature variation,**
- **power consumption,**
- **icing of evaporator**

and may result in loss of warranty.

Wheels / leveling feet



The device has been equipped with wheels or leveling feet. After placing the unit at its destination, secure the device against movement by locking the wheels. In the case of feet, after placing the device in the destination, they should be leveled.

If the device is equipped with wheels, they must be locked and leveled (wheels in ST 1200 M, ST 1450 M, CHL 1200 M, CHL 1450 M, ILW 750 cannot be leveled). For this purpose use the red knob mounted in the wheel housing. At the beginning, the knob can be turned by hand, if it encounters resistance, use a 13 size wrench.

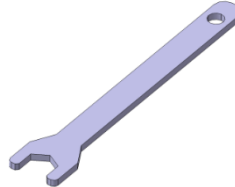

Leveling wheels are **ONLY** for positioning the device at its destination. They can not be used to transport the device!

If the device is to be placed on a table (option) or frame (option) which is equipped with the wheels with a lock, the wheels **MUST** be locked after placing the table / frame in its final destination.

Electric installation



Power supply of the equipment is indicated on a rating plate on the unit. Connect the device to a socket with ground in order to avoid electric shocks in case of the unit's failure.

The installation should be protected by a 16A slow-blow fuse and equipped with a residual current device.

3.1. Installation of shelves

In the ST 1-6, CHL 1-6 models

To install the shelf or to change its position, follow these steps:

Install the shelf slide at the selected height by inserting it into proper slots on the wall of the device. Do the same with the slide on the opposite wall.

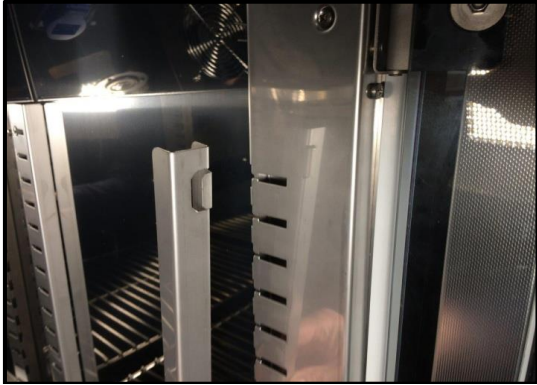

Slide the shelf into the installed shelf slides. Now, the shelf is correctly installed!

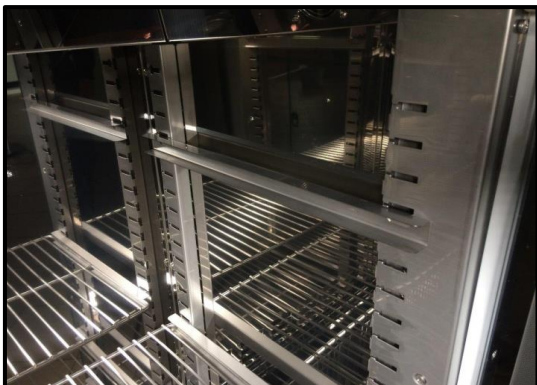

To remove a shelf, perform the above steps in reverse order. To remove the shelf slide from the slots, lift it up and slide it towards the rear of the chamber.

Instruction manual ST, CHL, ILW SMART PRO

In the ST 500 - 1450, ST 500 M - 1450 M, CHL 500 – 1450, CHL 500 M - 1450 M models

To install the shelf or to change its position, follow these steps:

Install the shelf slide at the selected height by inserting it into proper slots on the wall of the device. Do the same with the slide on the opposite wall.

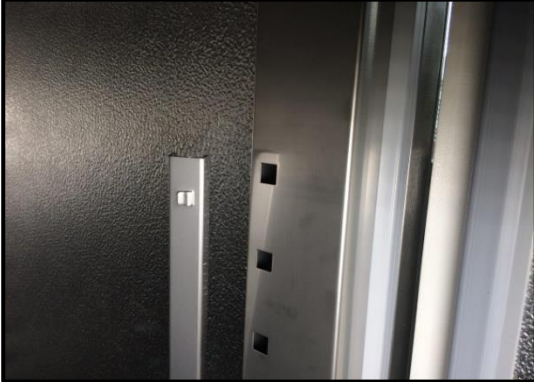

Slide the shelf into the installed shelf slides. Now, the shelf is correctly installed!



To remove a shelf, perform the above steps in reverse order.

In the ILW models

To install the shelf or to change its position, follow these steps:

Install the shelf slide at the selected height by inserting it into perforations on the wall of the device. Do the same with the slide on the opposite wall.



Slide the shelf into the installed shelf slides. Now, the shelf is correctly installed!





To remove a shelf, perform the above steps in reverse order.

3.2. Condensation in the chamber

If the set temperature is much lower than the ambient temperature, condensation may occur, which will cause accumulation of the water at the bottom of the chamber. The amount of accumulated water depends on the following factors:

- the difference between the ambient temperature and the temperature in the chamber,
- frequency of door openings,
- temperature of the samples.

	If water accumulates at the bottom of the chamber, wipe the bottom of the chamber with a dry cloth.
---	---

	Too high relative humidity in the chamber can cause icing of the cooling element, and thus reduce the cooling efficiency and increase power consumption.
---	--

Cartons, sponges and other hygroscopic materials should not be used to store samples, as they may increase the humidity in the chamber.

3.3. Remarks on the placement of samples

To provide proper air circulation and stable conditions in which the samples are stored in the chamber, it is necessary to keep the following rules:

- the max height of the samples should not exceed 1/3 of the space between the shelves,
- approx. 1/3 of the width and depth of the shelf should remain empty, while the distances between the samples, as well as between the samples and the wall should be approximately equal.

The picture below is an example of the placement of samples in the chamber.

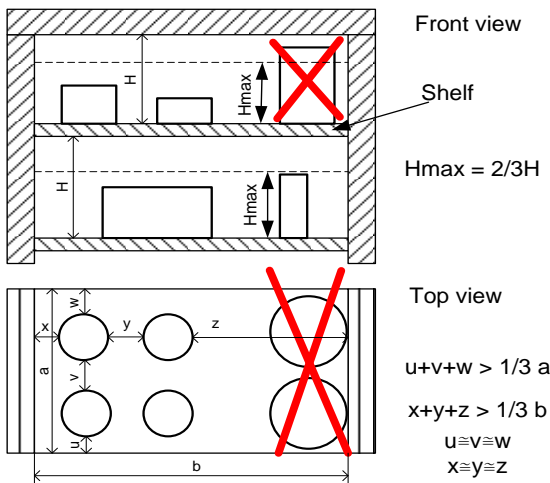

Following the above rules will provide best optimal parameters of temperature fluctuation and variation.

3.4. Closing chamber door

All units have been equipped with a gasket and open door sensor. If the door has not been closed properly, an audible and visual alarm will start. You can set delay door alarm by: 30s, 1 min, 2 min, 5 min or 10 min ([see Section 6.18](#)).

3.5. Anchoring of the equipment



In the case of high equipment (ST 500, ST 500 M, CHL 500, CHL 500 M, ST 700, ST 700 M, CHL 700, CHL 700 M, ST 1200, ST 1200 M, CHL 1200, CHL 1200 M, ST 1450, ST 1450 M, CHL 1450, CHL 1450 M) and multi-chamber units they must be anchored to the wall with suitable fixings (the anchoring kit is supplied with the device). This prevents the unit from falling over. **Lack of anchoring may result in damage to the device and in extreme cases may endanger the health or life of the person who using the device.**

Rear view

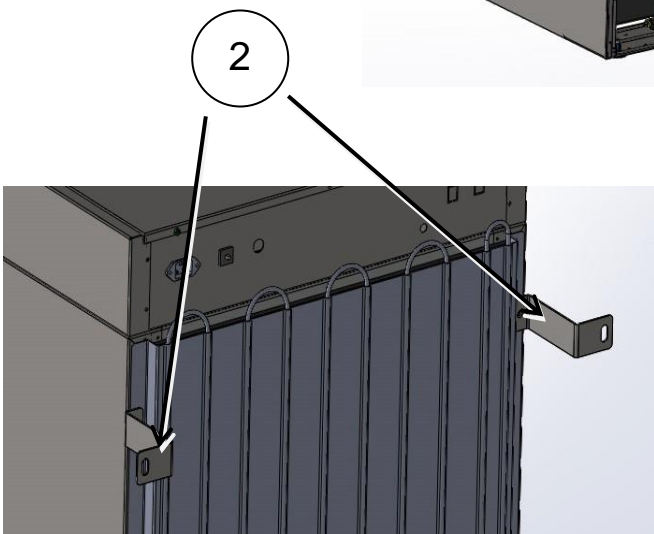
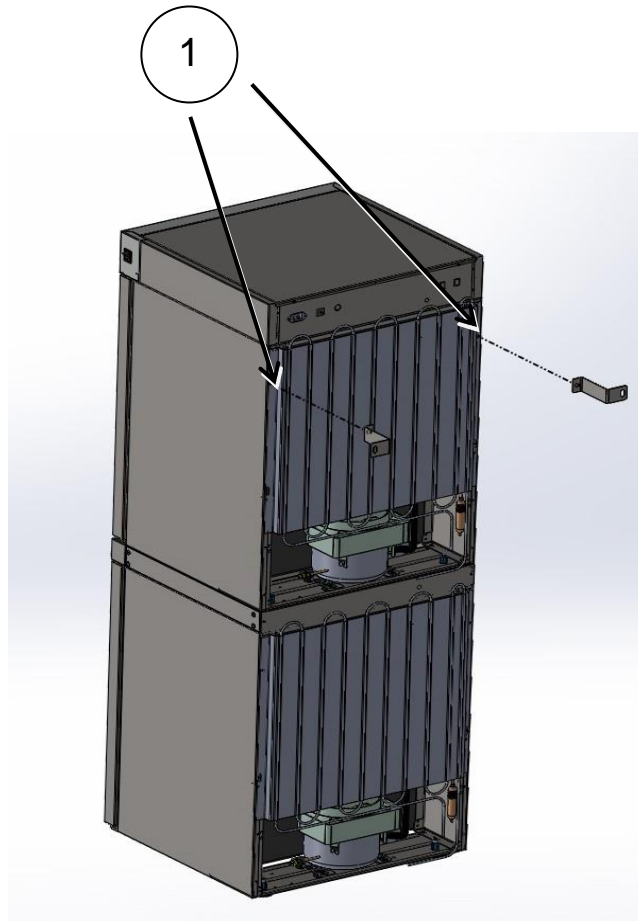

1. Install the mounting brackets (2) to the holes marked (1) on the back of the device using the supplied screws and nuts. Handles can be set up or sideways.
2. Place the equipment at the destination.
3. Use the $\varnothing 6$ mm wall plugs adapted to the anchoring point to attach the holders. Elongated mounting hole in the bracket 10x10.

4. DESCRIPTION OF THE DEVICE

SMART PRO models are equipped with a PID microprocessor temperature controller and a 7 inch colour touch screen with a resolution of 800x480.

4.1. Design of ST / CHL devices

Below there's a picture of ST model (exemplary photo) with a description of the important components of the device. CHL model looks identical.

Front view

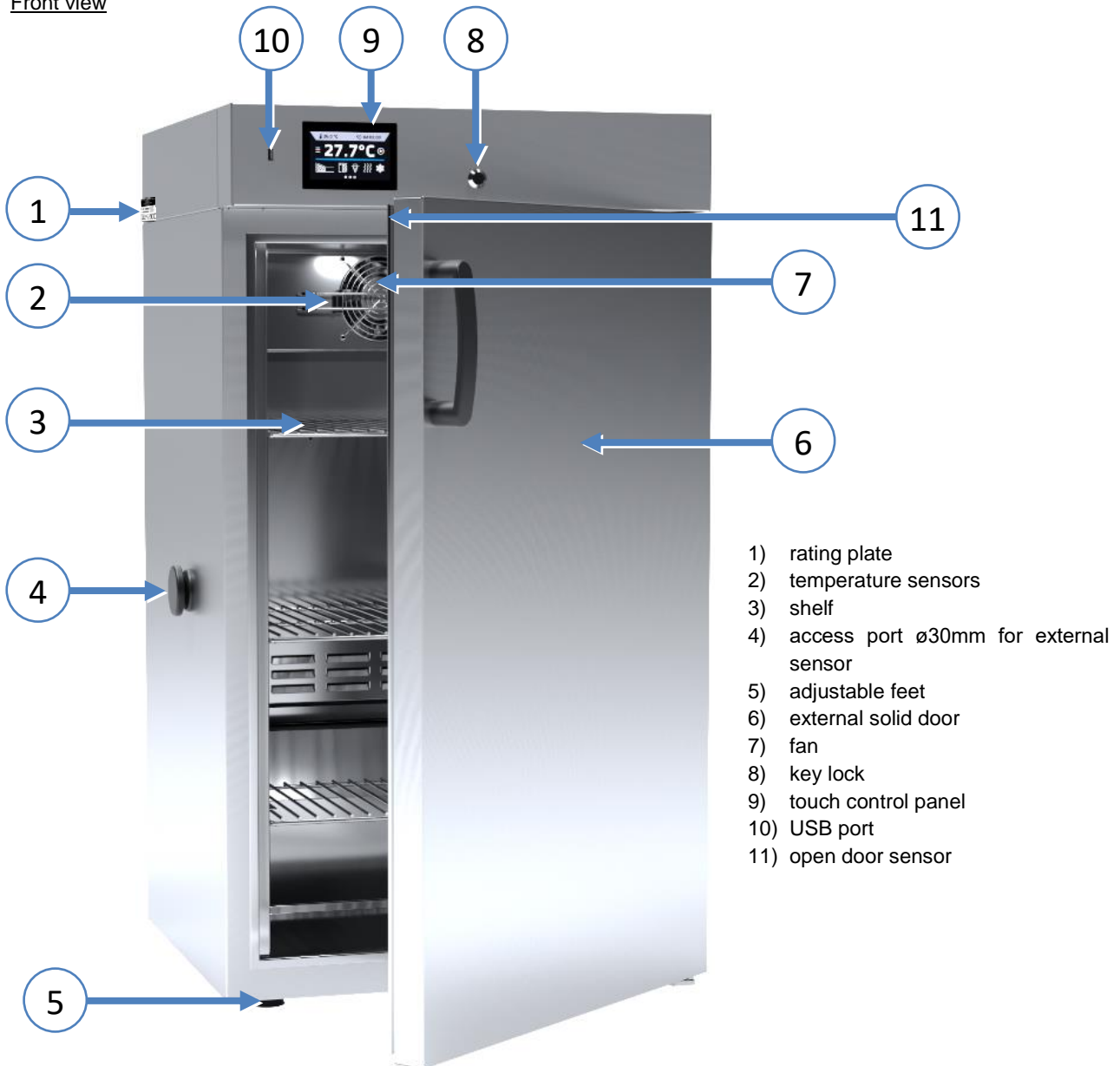

Rear view

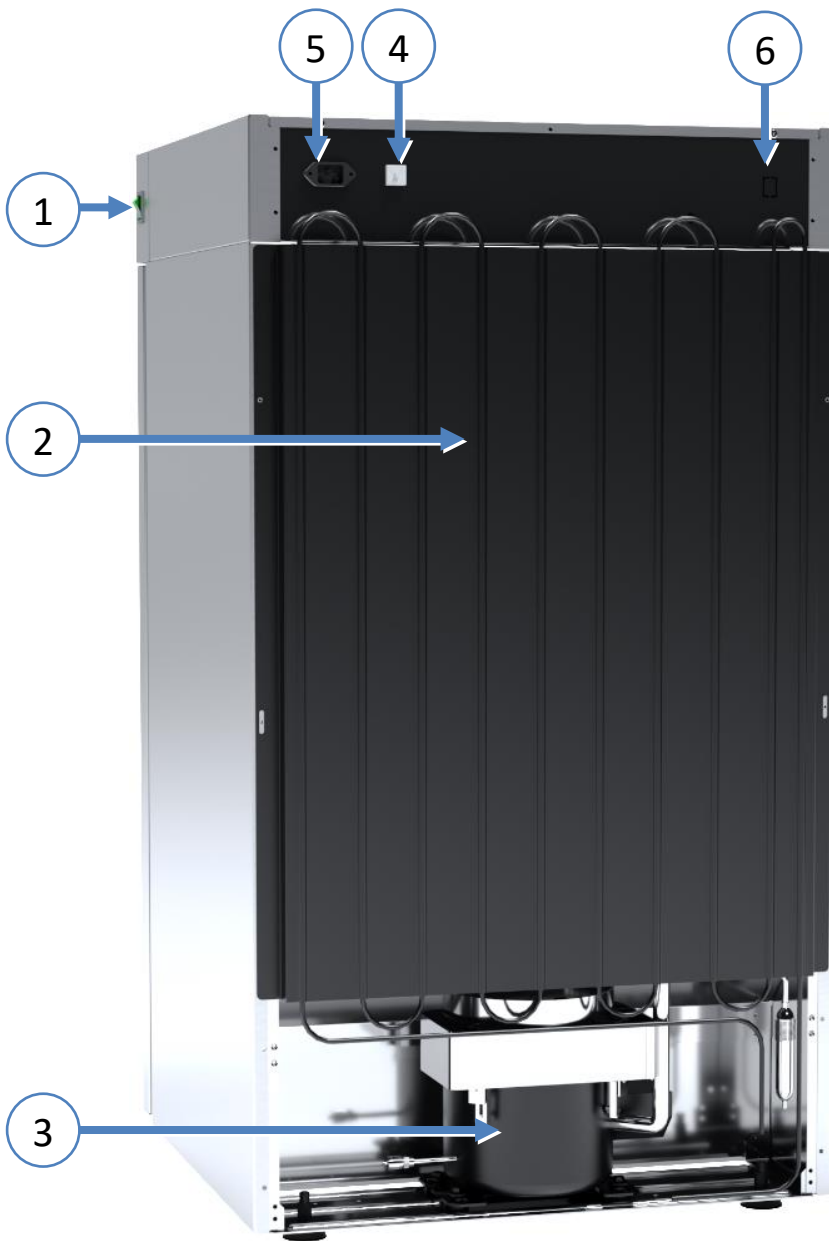

- 1) main switch
- 2) condenser
- 3) cooling system
- 4) fuse
- 5) main power socket C14
- 6) LAN port

Rear view (ST/CHL 500 M - 1450 M models)

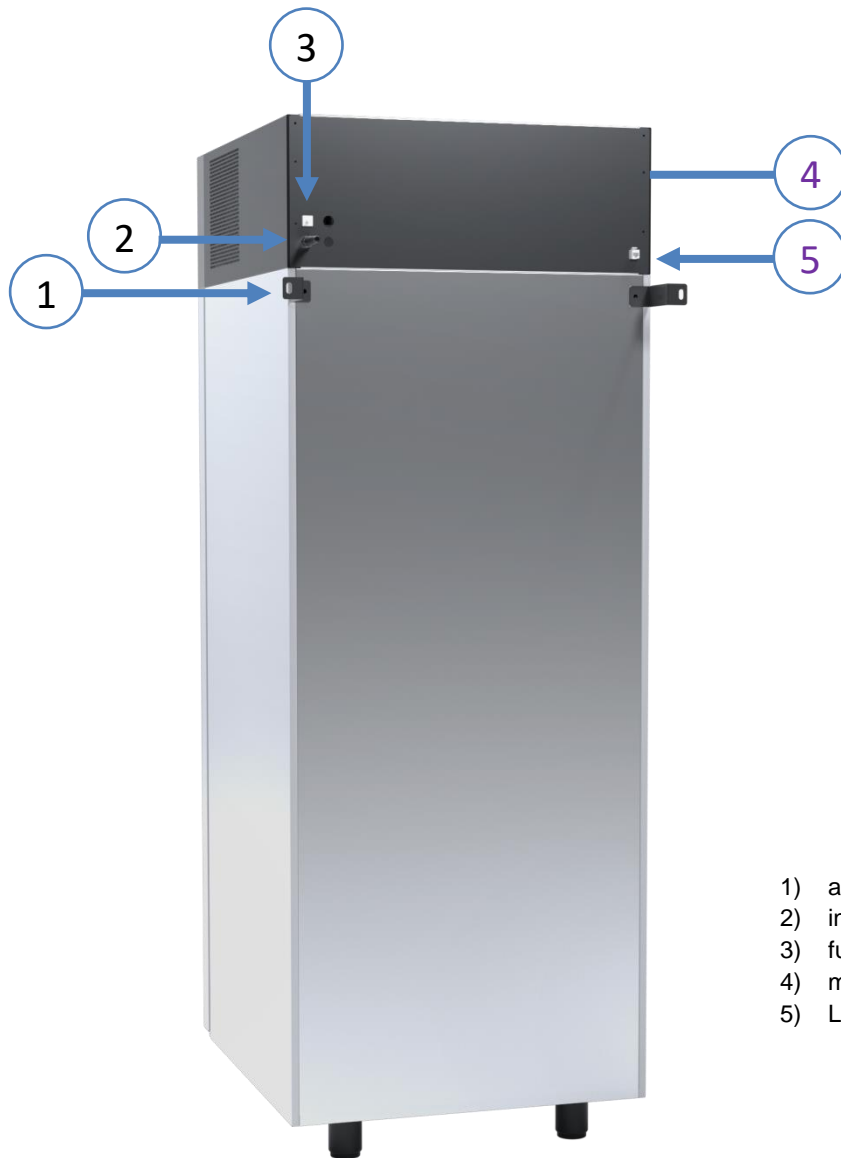

- 1) anchoring handle
- 2) integrated power cable
- 3) fuse
- 4) main switch
- 5) LAN port

4.2. Design of ILW devices

Below there's a picture of ILW 115 model (exemplary photo) with a description of the important components of the device.

Front view

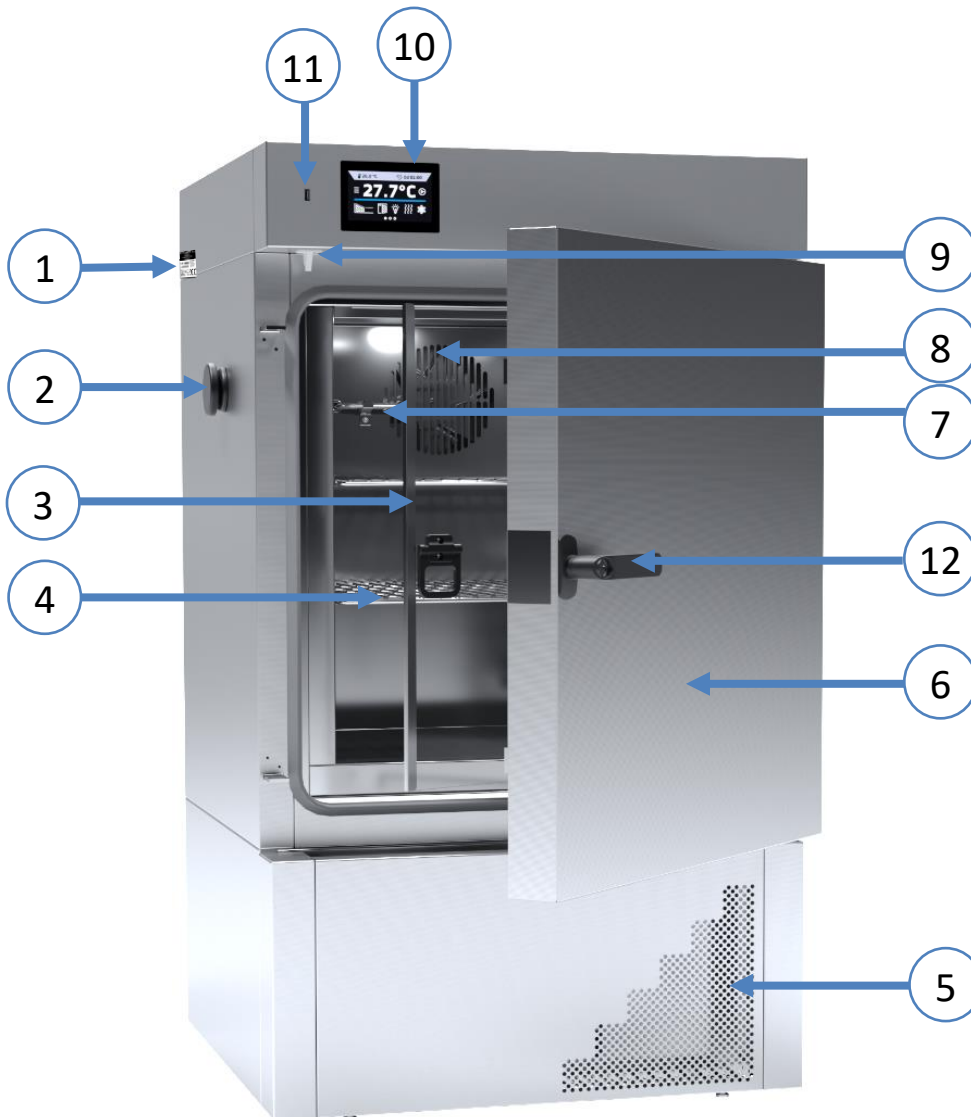

- 1) rating plate
- 2) access port \varnothing 30mm for external sensor
- 3) internal glass door
- 4) shelf
- 5) condenser housing
- 6) external solid door
- 7) temperature sensor
- 8) fan
- 9) open door sensor
- 10) touch control panel
- 11) USB port
- 12) handle door with key

Rear view



- 1) main switch
- 2) adjustable feet
- 3) LAN port
- 4) fuse
- 5) main power socket C20

5. DEVICE EQUIPMENT (STANDARD AND OPTIONAL)

5.1. Internal glass door (optionally for ST / CHL, standard for ILW)

Internal glass door is an optional equipment in ST thermostatic cabinets and CHL laboratory refrigerators. For ILW cooled incubators it's a standard equipment. To open and close the door use the plastic handle attached to the glass.



During operation, when the temperature inside the chamber is high, do not touch the internal components and glass doors, as there is a risk of burns. Use protective gloves to protect yourself against the effects of burns from hot components.



We do not recommend installing and removing internal glass door. Incorrect assembly or disassembly may result in damage to the glass and injury to the user.

5.2. External glass door (optionally for ST/CHL)

External glass door is an optional equipment in ST thermostatic cabinets and CHL laboratory refrigerators.



Due to external glass door the temperature range in ST thermostatic cabinets in SMART PRO version is reduced from 70°C to 40°C.

5.3. External door with viewing window (optionally for ILW)

The external door with a viewing window is an optional equipment for ILW cooled incubators.





During operation, when the temperature inside the chamber is high, do not touch the internal components and glass doors, as there is a risk of burns. Use protective gloves to protect yourself against the effects of burns from hot components.

5.4. Internal socket (optionally for ST, CHL, ILW)

An internal socket with grounding and IP44 protection is an optional equipment for ST thermostatic cabinets, CHL laboratory refrigerators and ILW incubators. The internal socket (depending on the model: 230V 50Hz / 230V 60Hz / 115V 60Hz) is intended for EU plugs or plugs type B. The socket can be used to connect electrical devices inside the device.



The maximum permissible load of all sockets inside the device (max. 3 pcs.) is 200 [W]. In the case of ILW incubators in the SMART PRO version with an internal socket, the operating temperature range is lowered to + 70 ° C.



Always make sure that the safety rules for working with electrical devices are followed!

5.5. Door lock (standard for ST, CHL, ILW)

All devices have a key lock. The key lock is situated above the door. Two or four keys are supplied with the device (depending on the model).



5.6. Access port for external sensor (standard for ST, CHL, ILW)

A Ø30 mm access port can be used to insert an external temperature sensor for independent temperature control inside the device. The access port has been secured with a rubber plug. The plug should cover the access port while the unit is operating. If multiple cables have been inserted through the access port and it is not possible to use the plug, secure the access port with adhesive tape. If you leave the access port open, it may affect temperature fluctuation and variation inside the chamber.





5.7. Open door alarm (standard for ST, CHL, ILW)

All units have been equipped with an open door sensor. If you open the door, the icon:  will appear (the number above the icon presents open door counter. Press the icon to cancel the counter. The counter is also cancelled by turning of the device). If the door remains open longer than the time set by the user (30s, 1 min, 2 min, 5 min, 10 min, see [Section 6.18.](#)) an acoustic signal, red pulsating alarm bar and „open door” alarm with active status will appear.







5.8. Internal LED light (standard for ST, CHL, optionally for ILW)

All ST thermostatic cabinets and CHL laboratory refrigerators are equipped with LED interior lighting integrated with an open door sensor (Philips Corepro LEDspot 3.5-35W GU10 827 36D). When the light switches on, the icon  will appear on the display. For devices with external glass door (ST, CHL) or with door with viewing window (ILW), additionally pressing the icon  allows you to turn on/off the LED lighting at any time.



5.9. USB port (standard for ST, CHL, ILW)

The USB port on the front panel is used only to transfer data from the device's internal memory to the flash drive. To do this insert the flash drive into the USB port on the front panel and then:

- go to the main menu ,
- go to the data record ,
- press  and choose type of the file: *.csv, or *.plx.
- press . Data has been copied.



After copying the data to the USB flash drive, before removing it from the USB socket, it should be unmounted by pressing the icon  in the top drop-down list (Figure 1). If the pendrive is not unmounted after connecting to the computer, a message about pendrive damage may be displayed with a repair proposal, when actually the pendrive is not damaged



Figure 1 Unmounting USB flash drive

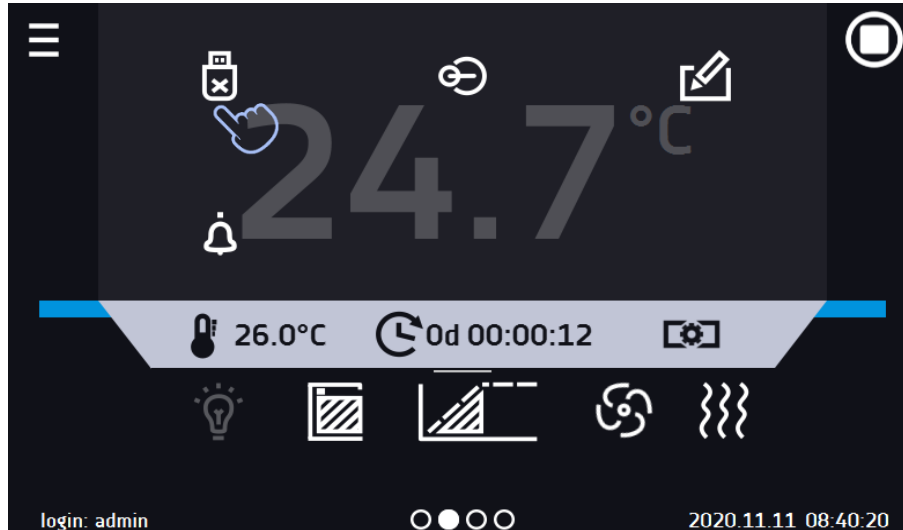

Data saved in the *.csv file can be opened in a spreadsheet. Data saved as *.plx can be opened in the Lab Desk program (standard equipment). This program allows, among others, for data preview in the form of a table or a graph. It also allows you to prepare a statistic report for a selected range of data, see Section 6.12.

5.10. Phytotron FIT (optionally for ST and ILW)

* The phytotron option is not available for thermostatic cabinets with a monoblock, i.e. ST 500 M, ST 700 M, ST 1200 M and ST 1450 M.

ST thermostatic cabinets and ILW laboratory incubators can be equipped with phytotron (FIT). Phytotron allows you to program the duration and intensity of light for each segment. Thanks to the phytotron (FIT) function it is possible to simulate day, parts of the day (e.g. dawn, noon, dusk), night, etc. If a phytotron is installed in the device, instead of the icon  in the main screen there is an icon  (internal LED light is not installed in devices with a phytotron) (Figure 2).

Programming options for the FIT version, see Section 6.7.3.:

- day and night simulation – it is possible to program temperature, time and intensity of the light for each segment,
- temperature range for „night“: +3...+60°C,
- temperature range for „day“: +10...+50°C,



For devices with a temperature range above +60°C, the range will be factory reduced to +60°C.

- standard fluorescent lamps, type 840, can be mounted in: side walls of the device, door, side walls and door, ceiling or as over-shelf illumination panel,
- operation with priority time.

Figure 2 Main screen for devices with phytotron

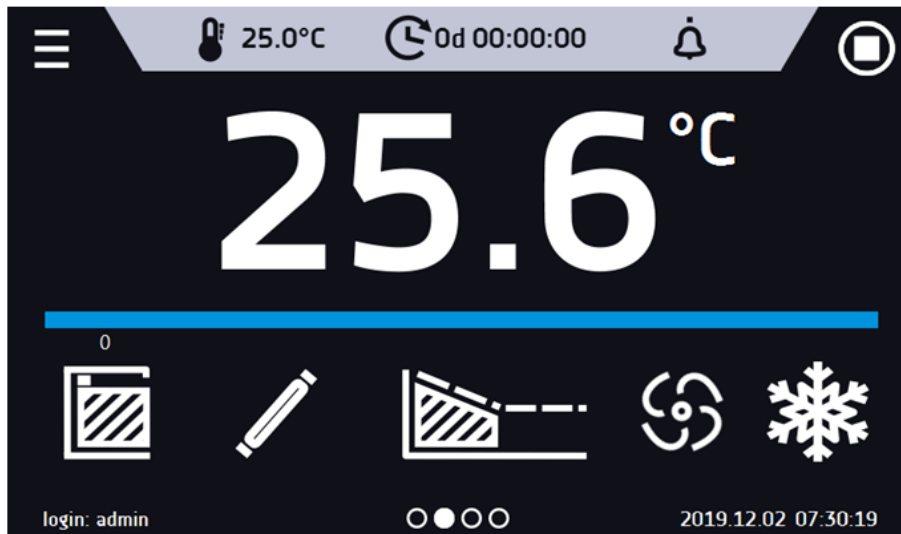

If a phytotron is not switched on, the icon  is inactive. To program a phytotron, see the [Section 6.7.3](#).

5.11. Display battery backup (optionally for ST, CHL, ILW)

Units in the SMART PRO version can be optionally equipped with a battery backup of the display. The power loss and switching to the battery backup display mode is signaled by a pulsating red frame around the display and a sound signal (if it is turned on). In the battery backup display mode, all parameters are displayed, ie temperature. Other alarms, e.g. exceeding the temperature range, are also signaled.

In order to extend the battery life, the display is dimmed all the time. Batteries are automatically charged in AC mode.

	Batteries should be replaced every 12 months. When it is time to replace the battery, a message will appear on the display, see Figure 3 . During the warranty period, the replacement should be performed by an authorized service. Otherwise, you will lose your warranty.
---	--

Figure 3 Message about the need to replace the battery.



6. DEVICE OPERATION

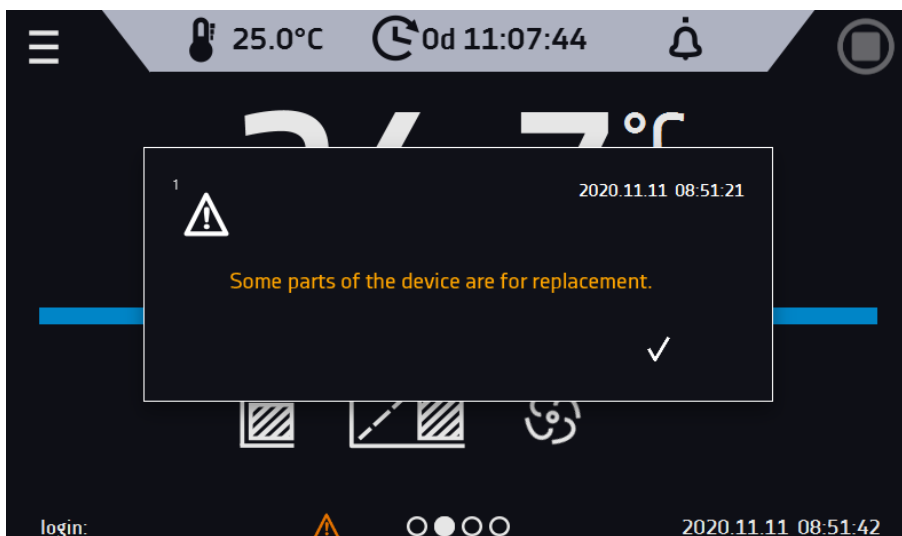

This symbol means that a given window can be moved in the direction shown in the picture.

6.1. External memory (USB flash drive)

The external memory (USB flash drive) allows to copy: instruction manual, data record, event log and service log from the device memory. Before first use the USB flash drive should be formatted in the FAT 32 file system. Insert the device in the USB slot on the front of the device next to the display. Wait a few seconds, the correct reading is indicated by the message „USB flashdrive connected” at the bottom of the screen.



USB slot is used to connect **only** a flash memory – a pendrive or a card reader with a memory card. Connecting any other device (e.g. external hard drive) without consultation is not authorized by the manufacturer and may damage the USB slot.



After copying the data to the USB flash drive, before removing it from the USB socket, it should be unmounted (see [Section 5.8.](#)).

6.2. First boot

During the first boot, the screen ([Figure 4](#)) will display information about saving the "Download" folder (with instruction manual) on the USB flash drive in pdf format. In order to do it, insert the USB flash drive and wait a second to detect the hardware, then press .

If you press you quit downloading the folder. The window will appear again during the next boot. You can tick „Don't show again” so that the window will not be displayed after switching on the device. You can always download the „Download” folder in the Info submenu. More information [Section 6.14.](#)

[Figure 4](#) Downloading files

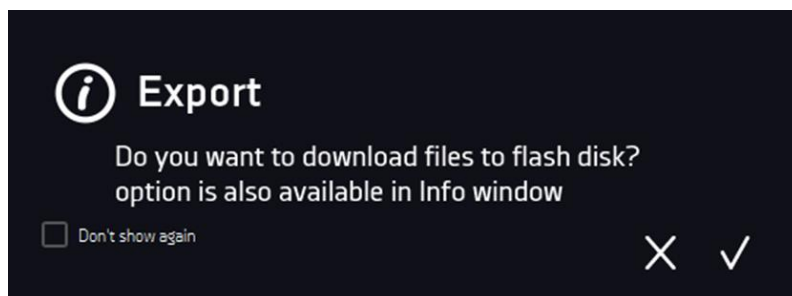

6.3. Using the keypad

When operating the device, sometimes it is necessary to enter alphanumeric characters (e.g. when logging into the system, entering the user name, etc.). In such cases, a keyboard appears on the display screen ([Figure 5](#)). In addition to the standard letters, it contains symbols that correspond to the computer keyboard.

Figure 5 Keypad

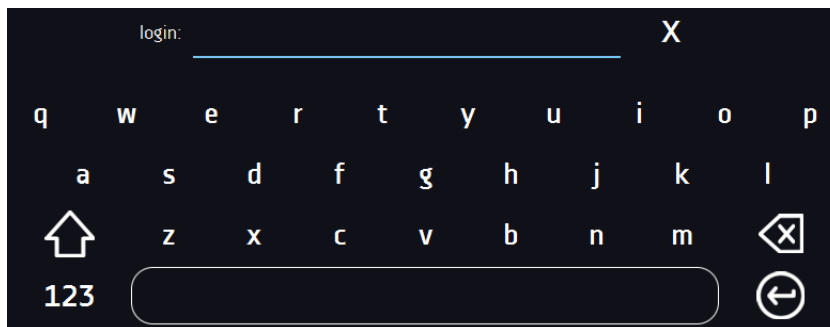

Deleting the entire text



Changing to capital letters (it's matters when entering login and password).



Changing to numbers and special characters.



Changing to letters.



Deleting the entered character.



Confirming the entered text / closing the keypad.



Sometimes entered characters can be hidden (then they are replaced with „*“). This happens when classified information is entered (e.g. when a user enters a password).

6.4. User logging in

Setting device parameters is only possible by the logged in user. To log in, press  in the main screen. The login window will appear (Figure.6):

login: from 1 to 10 characters

password: from 1 to 10 characters

Factory default login parameters:

login: admin

password: leave the password field blank

Figure 6 Login panel

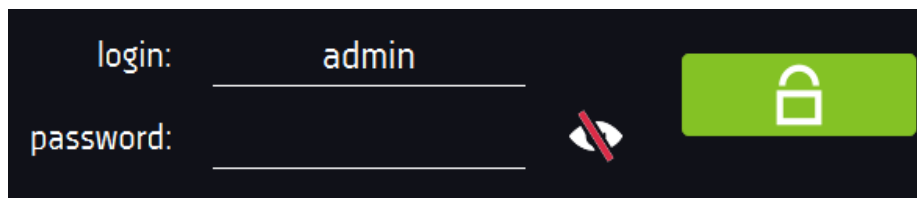

It is recommended during the first boot to set the password of the Admin account and write it down in a safe place to avoid tampering with the device settings by unauthorized persons.



The password should be remembered or noted down because it is not possible to delete the password of the admin account. If you lose your password, please contact the manufacturer's service. Deleting the password is not covered by the warranty.

For information on user account types, see [Section 6.15.2](#).

Logging out: press  in the main menu. For automatic logout, go to the [Section 6.16](#).

6.5. Main screen

After turning on the device, the main screen ([Figure 7](#)) appears. It contains the information about the device status. After starting the program, additional information appears on the screen ([Figure 8](#)).

Figure 7 Main screen (program is switched off, no user is logged in)

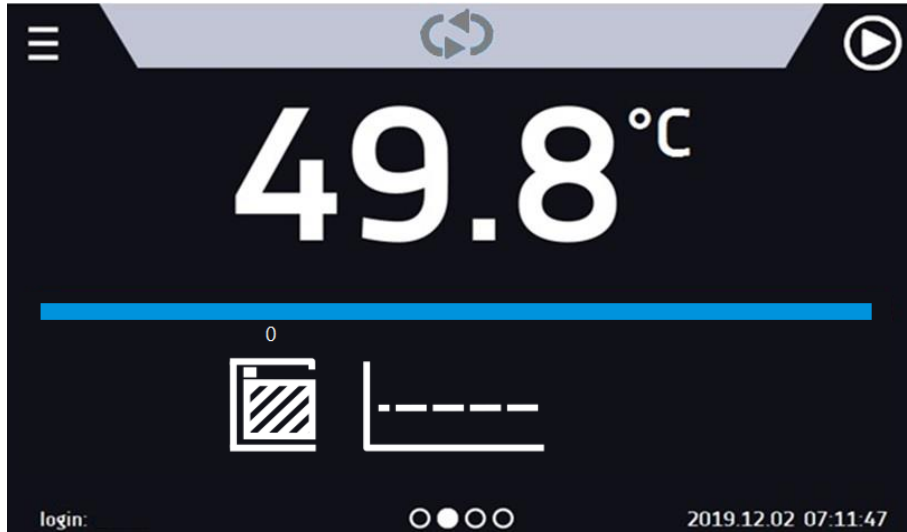

From this point, any action requires logging in.

Figure 8 Main screen – running program in ST, CHL, ILW

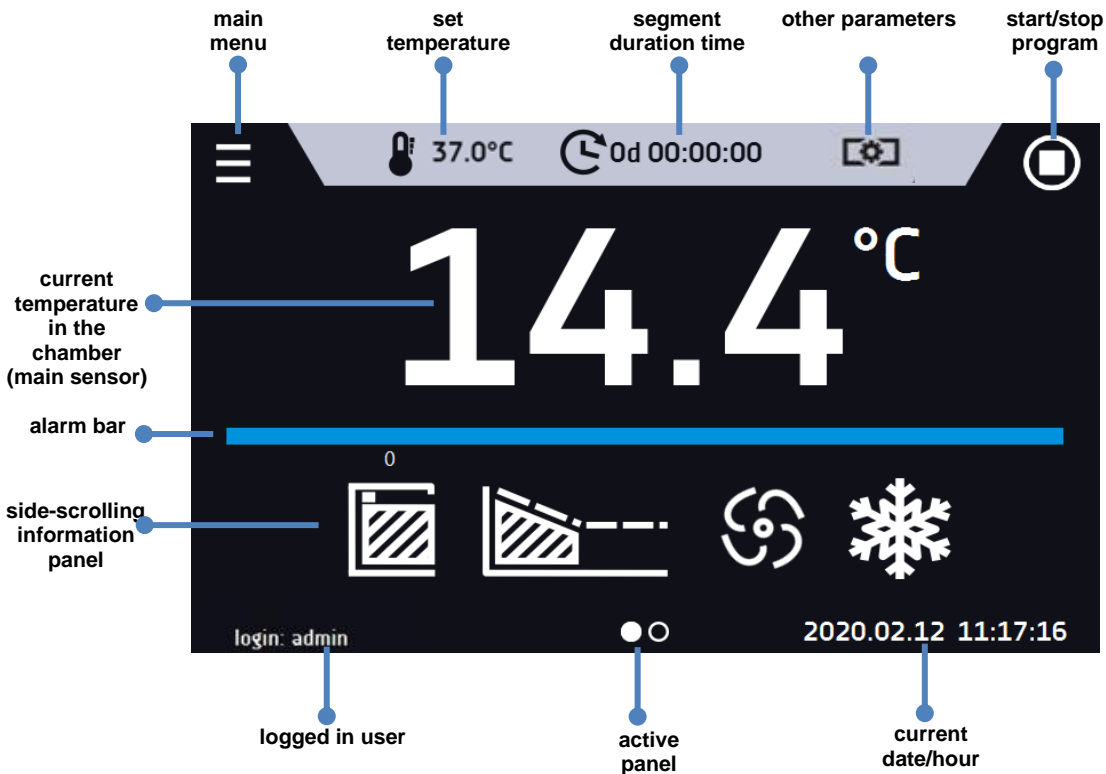

6.5.1. Information panel

There are four different windows in the information panel. Switching between them is done by swiping the finger left or right.



Figure 9 Information panel

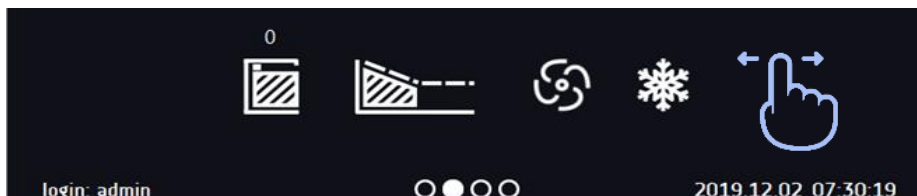

The icon  indicates information about which window is active.

6.5.1.1. Alarms panel

On the first page of the information panel there's alarms panel (Figure 10).

Figure 10 Icon: Alarms panel



In the alarms panel there's a list with active alarms or the alarms that have occurred but have not been confirmed. When the alarm is active, the alarm bar is red and the alarm event is displayed in the list with the status "active". When the alarm event stops, the state changes to "inactive".

- "delete" button – confirms and removes the alarm from the list (only inactive alarms can be deleted),
- "confirm" button – confirms an alarm,
- "details" button – displays a preview of all instances of selected alarm (Figure 11).

Figure 11 Alarm details

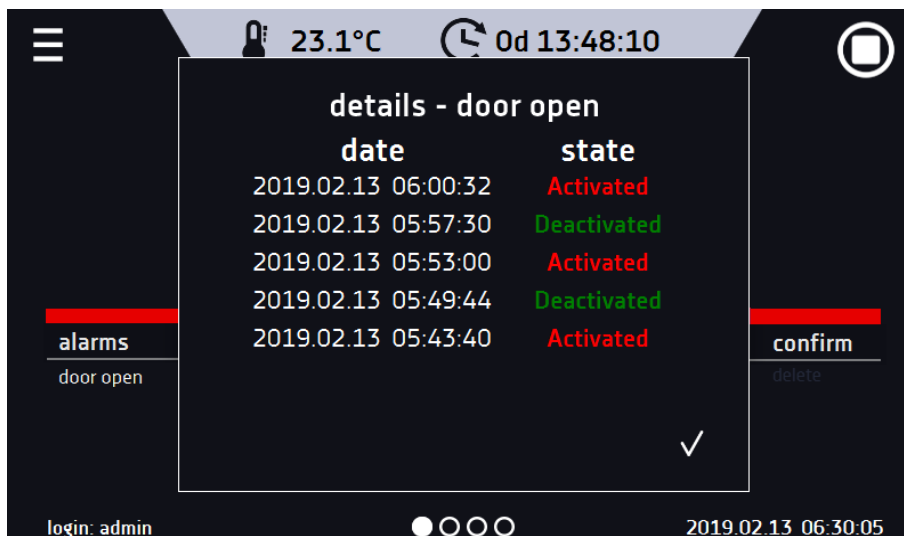

With more alarms, a button  appears on the right side of the list and allows you to enlarge the view to full screen.

6.5.1.2. Status panel

The status of the device is displayed descriptively on the third page of the information panel (Figure 12).

Figure 12 Status - description

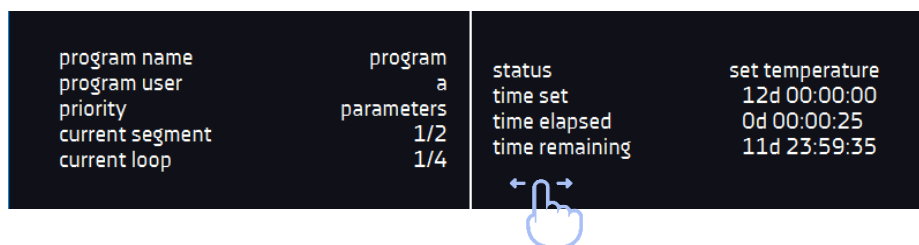

program name	the name of running program
user	name of the user to whom the program is assigned
priority	of time or parameters
current segment	currently running segment / total number of segments in the program
current loop	currently performing cycle/ total number of cycles to perform
status	stage of device operation, e.g. reaching or maintaining of set temp.
time set	set time of running segment
time elapsed	elapsed time since the segment has started
time remaining	remaining time until the end of the segment

6.5.1.3. Status panel – protection and alarms













On the fourth page of the information panel there is an information about the protection class along with the set protection temperatures as well as an alarm for the upper and lower temperatures. This information is associated with a running or finished program. For information on protection classes, see Section 6.7.5.

The second part of the panel (on the right side) displays information about set upper and lower alarms. To set alarms, see Section 6.18. Value „-“ means the alarm is off.

Figure 13 Status – protection and alarms

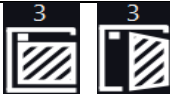





6.5.2. The meaning of icons and symbols

	The icon allows you to go to the main screen.
	Automatic return to the home screen. Factory setting: disabled.
	The icon allows you to go to the main menu.
	Automatic logout. Factory setting: disabled.
	Automatic screen lock. Factory setting: disabled.
	Internal light is switched on. It's automatically turned on when the door is opened and turned off when it is closed. By clicking the icon  on the status panel you can manually turn on / off the light (applies to devices with external glass door or door with viewing window). The icon does not appear in the models with phytron where the interior LED light in the ceiling is not installed.
	The FIT light icon (optionally for ST and ILW) symbolizes the turned on lighting of the chamber, controlled from the program. Does not apply to equipment with a monoblock (ST 500 M, ST 700 M, ST 1200 M, ST 1450 M).
	Unmounting the USB flash drive before removing it from the USB socket.
	Closed door, open door. The number above the icon presents open door counter. Press the icon to cancel the counter. The counter is also cancelled by turning of the device.
	Fan icon. Rotating icon shows that the fan is running. Quick Change function - clicking the icon allows you to change the fan efficiency (without editing the program) in the range of 10% ... 100% (it's a standard equipment for ILW), in the range 50%...100% (for ST 1-6, CHL 1-6). In the models with monoblock (ST 500 M – 1450 M, CHL 500 M – 1450 M) it's not possible to control fan efficiency.
	Ramp status: Chamber is currently heating up or cooling down.
	Set temperature is reached.
	The program will start on the given date / time. Schedule or start delay activated.

Instruction manual ST, CHL, ILW SMART PRO

	<p>Schedule activated - the program will run from-to the given date / time</p>
	<p>Icon is visible only when the chamber is cooling down.</p>
	<p>Icon is visible only when the chamber is heating up.</p>
	<p>Icon is visible only when the automatic defrosting function or defrosting program is running.</p>
	<p>Available when the program is running Clicking the icon allows you to quickly change the set temperature (Quick Change function).</p>
	<p>When the program is running, click the icon to quickly change the time of program duration (Quick Change function). Indicates the time that has elapsed from the program start.</p>
	<p>Countdown of the time remaining to the end of the program.</p>
	<p>The arrow icon allows navigation between: segments, program parameters and summary.</p>
	<p>Starting the selected program. In the list of programs - the program is running.</p>
	<p>Stopping the program.</p>
	<p>Adding a new program to the program list. The limit is 40 programs.</p>
	<p>Editing the selected program from the list. In the program list, a new program has been created but not approved yet.</p>
	<p>Removing selected program from the list.</p>
	<p>Going to the menu to create, edit, delete and start programs.</p>
	<p>Canceling adding or editing of the program. Cancelling changes.</p>
	<p>Editing individual program segments (the program can have max. 100 segments).</p>
	<p>Immediate start of the program selected from the program list.</p>
	<p>Delayed start of the program from the list of programs. The program starts according to the set date and time.</p>
	<p>Going to the SMART program (Quick Program function).</p>

	Turning off of the alarm sound (open door alarm, exceeding temperature range). Critical alarms (i.e. damage to the temperature sensor, temperature protection, etc.) continue emitting a sound.
	When the program is running, click the icon to quickly change the fan speed in ST 1-6, CHL 1-6 and ILW (Quick Change function).
	User message. Clicking on the icon allows you to enter a message.
	The icon appears in the event log and symbolizes entered user message.
	Active STM function (Smart Temperature Monitor) informs the user about the problem of reaching or maintaining the set temperature. <ul style="list-style-type: none"> • white color - option enabled, the program is stopped • blue color - option enabled, the program is running red color - warning about problems with reaching / maintaining the temperature

6.5.3. Upper expandable and configurable menu

In the upper part of the main screen there's a bar menu with parameter icons (unmounting USB flash drive, temperature, time, mute function and fan speed for ILW). These parameters can be quickly changed (Quick Change).

After swiping your finger down (Figure 14, 15) you will see icons for all parameters which can be quickly changed (Quick Change, see Section 6.9) and the USB flash drive unmounting icon (see Section 5.8). Among the options available in the bar you will find the following icons:







-  USB flash drive unmounting – more information [Section 5.8](#).
-  Quick Note – more information [Section 6.5.4](#).
-  mute option. Critical alarms (i.e. damage to the temperature sensor, temperature protection, etc.) continue emitting a sound, see [Section 6.18.1](#).
- Quick Change (more information [Section 6.9](#)) of:
 -  program duration time,
 -  set temperature,
 -  fan efficiency (for ST 1-6, CHL 1-6, ILW).

Figure 14 Upper expandable menu when the program is running

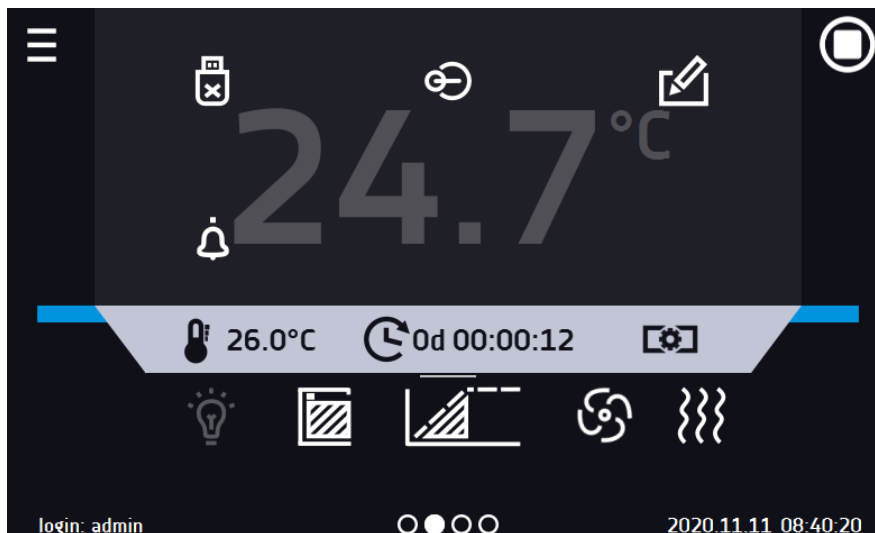
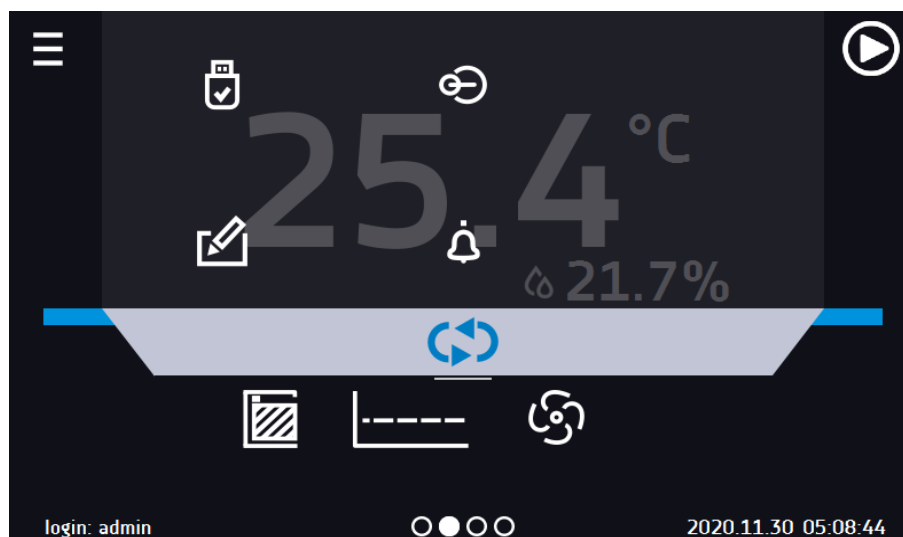
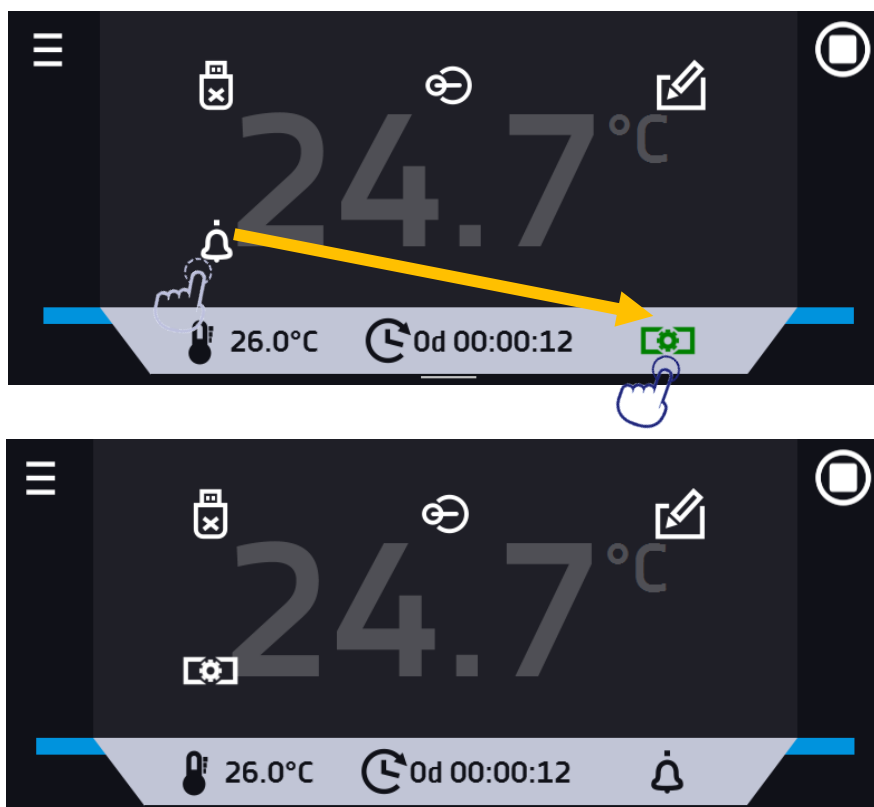

Figure 15 Upper expandable menu when the program is stopped



Positions available on the upper bar can be personalized. Just drag the selected icon to a new location (Figure 16).

Figure 16 Changing icon's position



6.5.4. Quick Note – user's message

During equipment's operation, the user can save messages in unit's memory with information about: the date of inserting a new sample, observed changes in the samples, the place of sampling, etc. To enter a message you must first log in and then press the icon  in the main screen in upper menu. Click on „Write a message” (Figure 17).

Using the keypad, enter the message and confirm it with the button . Once entered, a message cannot be



changed. Entered notes can be seen in the event log, they are symbolized by the icon . More information [Section 6.13](#).

Figure 17 User's message



6.5.5. Alarm bar

The Alarm Bar is a quick visual information about the device status. The colour of the bar indicates the status of the device:

-  – blue - the device is working properly
-  – red bar and pulsating frame – active alarm

6.6. Quick Program

Quick program allows you to quickly start the program from the main screen position without having to enter to the menu .



Quick program has several features that guarantee its uninterrupted operation:

- you can not set the duration of the program - time is always set to infinity,
- if the display fails, the program continues,
- after the power supply is resumed (after its failure), the program continues,
- to prevent the program from stopping accidentally, the STOP button was removed from the main window (Figure 18).

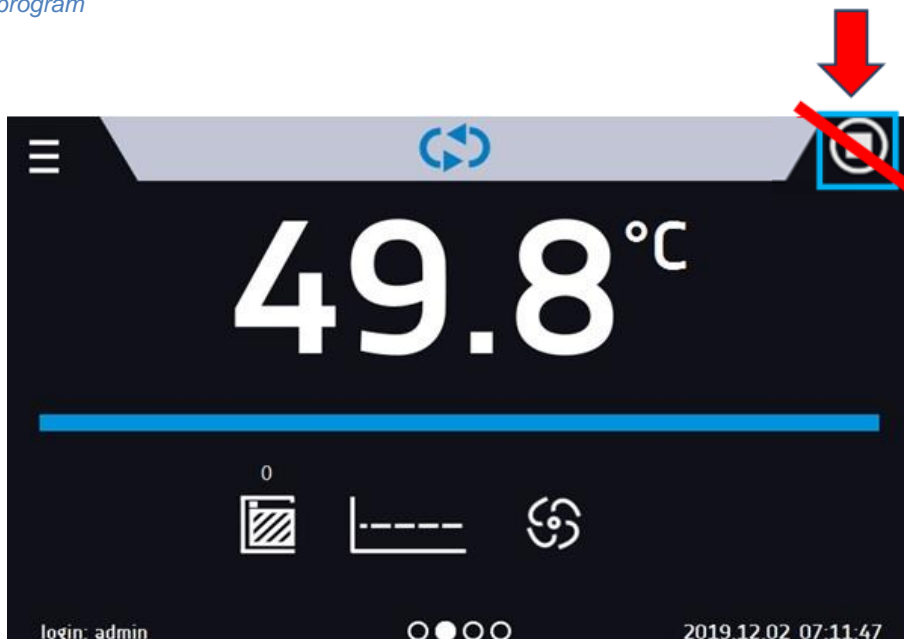
Figure 18 Quick program



In order to go to Quick program, first you have to log in (if none of the users is logged in, the icon of Quick program will be inactive - grayed out). Then click the icon  in the main screen. By clicking the appropriate icon you can set (Figure 19):

-  temperature,
-  fan (for ST 1-6, CHL 1-6, ILW).

Clicking the icon  starts the program in continuous mode (time set to infinity).

Figure 19 Starting the Quick Program



Stopping a Quick program has been made difficult on purpose (this prevents the program from being stopped accidentally) – to stop a program, you have to:

1. go to the menu ,
2. click the program window ,
3. keep pressing STOP button  for 5 seconds.

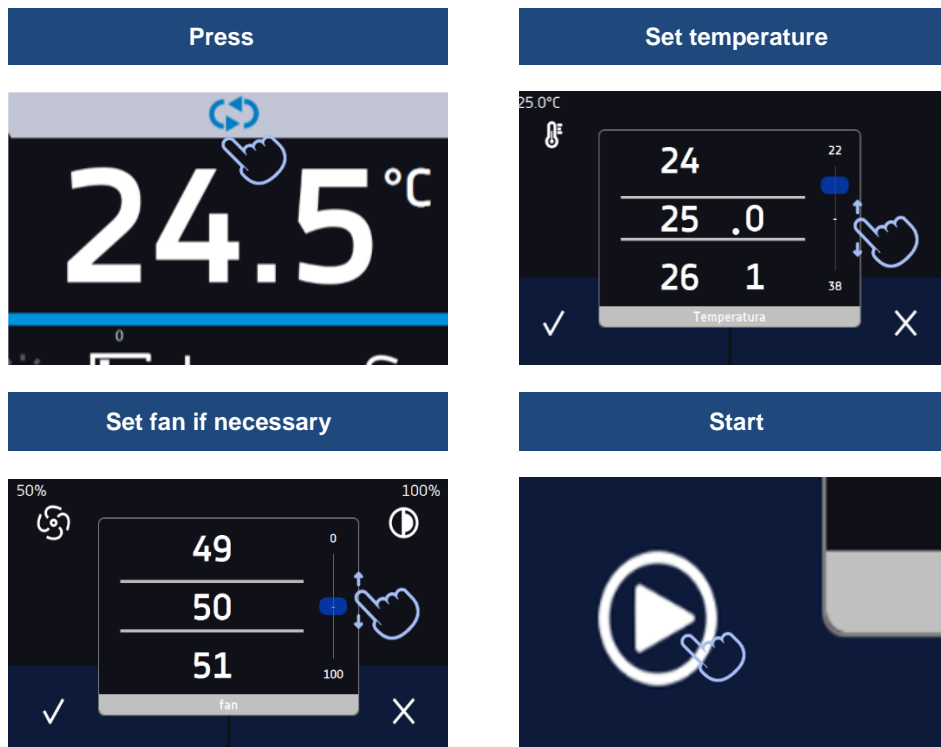
After configuration of the Quick Program, it appears in the programs list (Figure 20). Quick Program is displayed at the top of the list by default. Moreover, it cannot be deleted and cannot be assigned to a user of the User type.

Figure 20 Quick program on programs list

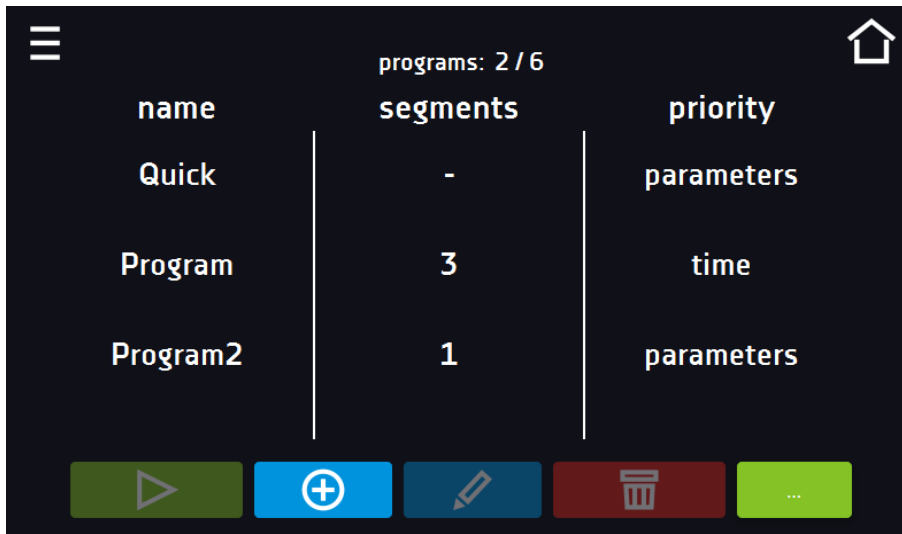

In Quick program editing mode, you can change:

- settings of the data recording interval,
- settings of the protection class.

Temperature protection

The highest protection class available for the device is set. The protection values depend on the set temperature:



- set temperature $\leq 15^{\circ}\text{C}$: lower protection = set temperature $- 2^{\circ}\text{C}$, upper protection = 30°C
- set temperature $> 15^{\circ}\text{C}$: lower protection = set temperature $- 5^{\circ}\text{C}$ (max 20°C), upper protection = set temperature $+ 5^{\circ}\text{C}$ (min. 30°)

When the program is running you can change the parameters (temperature and fan if available) by pressing the icon



or . During next launch of the Quick program, your previous settings will be remembered.

6.7. Programs

Press the icon of main menu , and then press . In this panel (Figure 21) you can run the selected program, add a new one, edit the program, delete it or share it with another user and download the program from a USB flash drive. The number of programs that can be created depends on the limit assigned by the **Super Admin** user. More information on the rights and configuration of account types (Super Admin, Admin, User) see [Section 6.15.2](#).









-  Start the selected program.
-  Stop the program.
-  Add a new program.
-  Edit the selected program.
-  Delete the selected program.
-  Download program from USB flash drive.
-  Share the selected program with the user type account.

Figure 21 List of programs

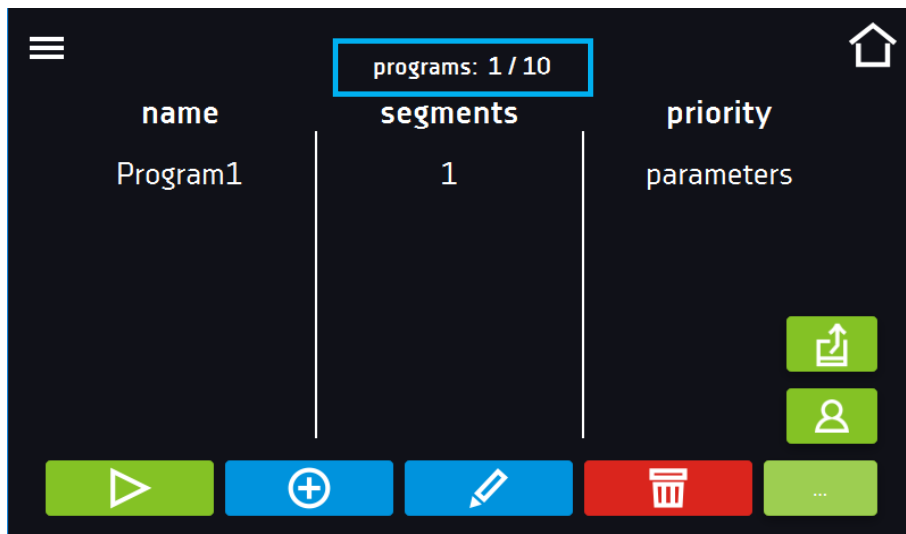

Information on the number of created programs / the maximum number of programs that the user can create is at the top of the screen (programs: 1/10).

6.7.1. Creating / editing a program

Press the button  or  and a panel with program parameters will appear (Figure 22).

In this panel you can set:

- **Program name** – after clicking, the keypad will appear and you will be able to enter the program name,
- **Segments number** – max. 100 segments
- **Interval** – frequency of saving the data in the data record (1 min, 2 min, 5 min, 10 min, 15 min, 30 min, 1 h), more information
- **Protection class** – more information [Section 6.7.5](#).
- **Temperature protection** – temperature range for the protection class, more information [Section 6.7.6](#).
- **Priority** – the priority of time or parameters, more information [Section 6.7.7](#).
- **Loop** – the number of program repetitions, more information [Section 6.7.8](#).

Figure 22 Program parameters

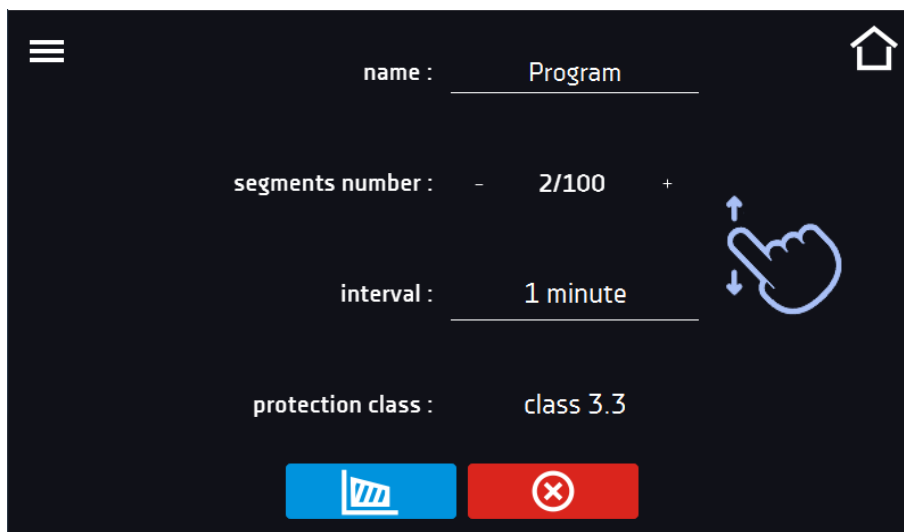

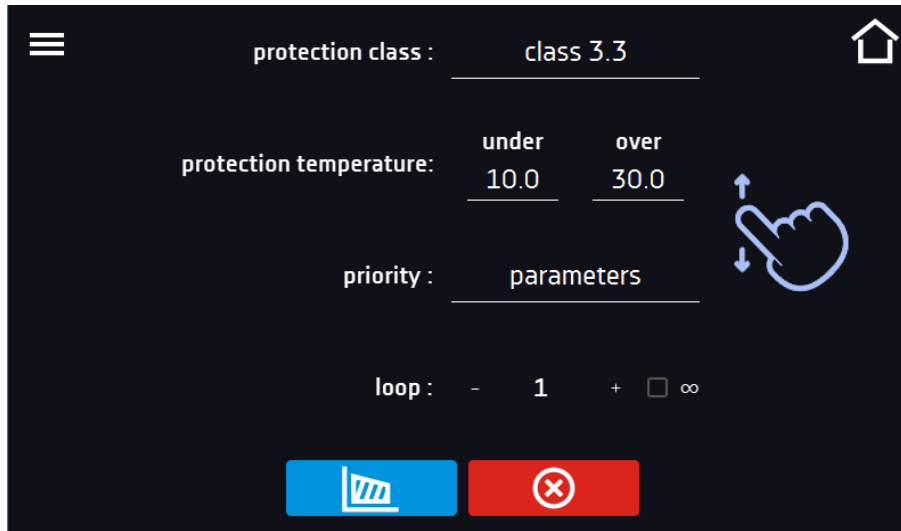

Cancels adding or editing of the program.



Going to the edition of program segments.



With more parameters, the window can be scrolled up and down.

6.7.2. Segments edition

For each program, you can set maximum 100-segment time-temperature profiles that allow you to gradually increase or decrease the incubation temperature of the samples. This can e.g. protect the sample from so-called thermal shock. Example of program operation with programmed segments (parameters priority):

Program 1

- segment1: temp. 30°C, time 2 hours (after reaching the temperature 30°C, it is maintained for 2 hours)
- segment2: temp. 40°C, time 3 hours (after reaching the temperature 40°C, it is maintained for 3 hours)
- segment3: temp. 50°C, time 3 hours (after reaching the temperature 50°C, it is maintained for 3 hours)
- segment4: temp. 40°C, time 2 hours (after reaching the temperature 40°C, it is maintained for 2 hours)
- segment5:
- segment6:

Press the button  and the first program segment will appear (Figure 23).

In this window you can set:

- **temperature** – target temperature which the device is to achieve in this segment (needs to be minimum 2°C below the value for over temperature protection and minimum 2°C above the value for under temperature protection),
- **time** – the time of maintaining the set temperature ([d hh:mm]) in days, hours and minutes. It is possible to select continuous work ∞ in the last segment,
- **ramp time** – the time of reaching the set temperature ([d hh:mm]) in days, hours, minutes.

The following parameters are available in selected models or as additional paid options:

- **fan** - fan efficiency in percent (for ST 1-6, CHL 1-6, ILW),
- **fan ramp** – fan efficiency when reaching the set temperature (for ST 1-6, CHL 1-6, ILW),
- **light (phytotron)** – setting the FIT light in the segment (for ST and ILW as option).

Instruction manual ST, CHL, ILW SMART PRO

The active value is highlighted in blue. The item highlighted in red means that the value is out of range and you should enter another one, e.g. the temperature is above / below the operating range of the device or the protection temperature.



The fan efficiency set to 100% is the default value. Reducing the fan efficiency may cause improper operation of the device, e.g. chamber icing, worse fluctuation and variation of temperature, excessive condensation of water.



Ramp time - setting a short time will not accelerate reaching the ramp, but the ramp will be reached in the shortest possible time depending on the set temperature, ambient conditions and the possibilities of the cooling or heating system in the device.

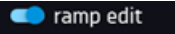

The ramp parameters are factory set in accordance with the manufacturer's instructions. If it is necessary to set individual parameters when reaching the segment temperature, activate the edit ramp field  and set your own values.



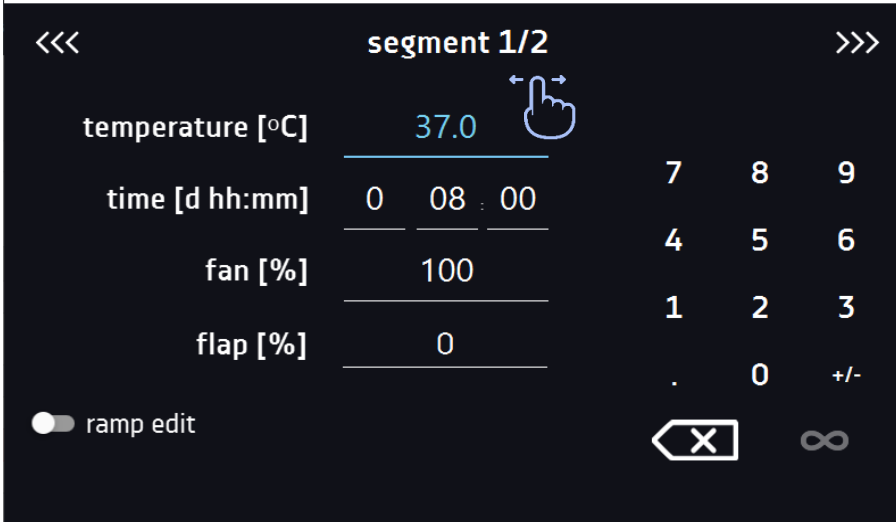

With more parameters, the window can be scrolled up and down.

Figure 23 Program segment edition



<<<	segment 1/2	>>>
temperature [°C]	37.0	
time [d hh:mm]	0 08 : 00	7 8 9
fan [%]	100	4 5 6
flap [%]	0	1 2 3
		. 0 +/-
<input type="checkbox"/> ramp edit		 

The navigation between: segments, program parameters and summary is done by touching the icon  .



If, when editing a program, you automatically return to the home screen or you are automatically logged out, the edited program will not be lost, but saved as a draft (see below).

After configuring all segments, a window with the security class is displayed (Figure 24). For class 3.1 (standard) you can set the protection temperature.

(Figure 24). Security class 3.3.

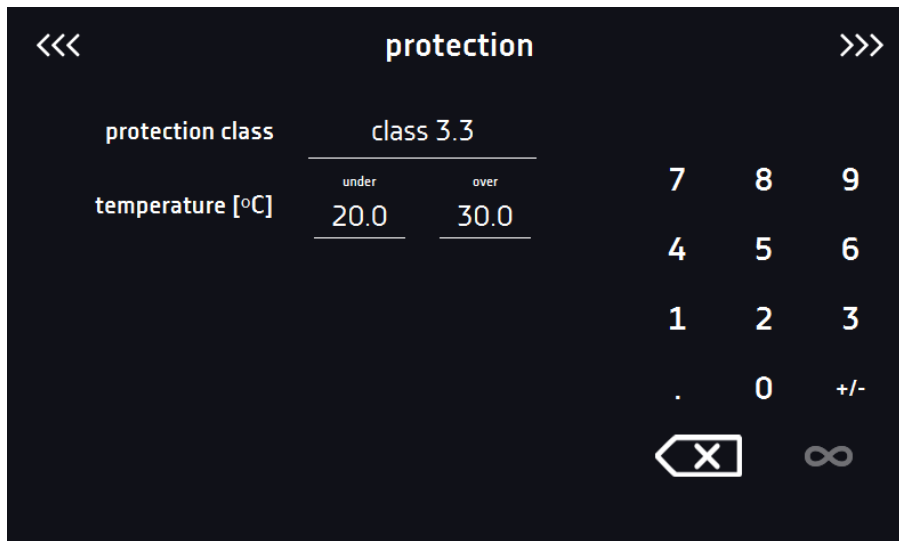

After switching to program editing again, information appears about the possibility of continuing changes to the program settings (Figure 25).

Figure 25

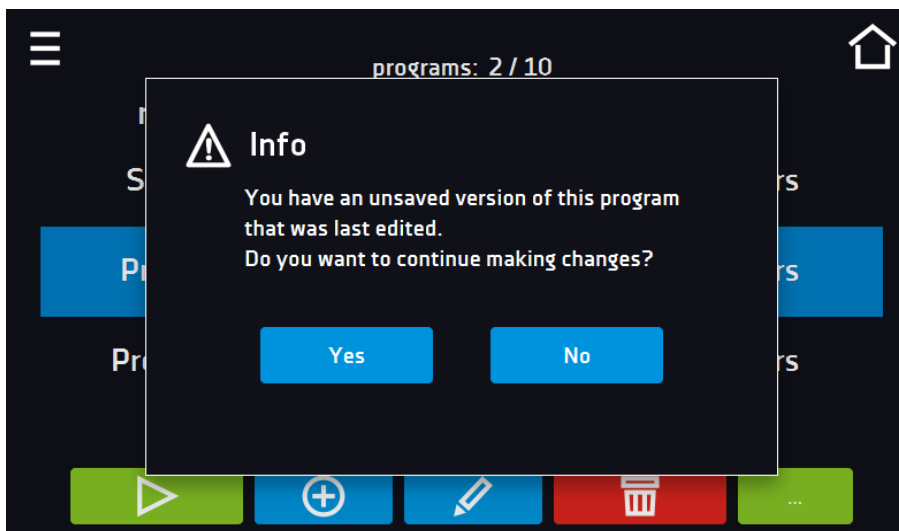

6.7.3. Phytotron FIT (optionally for ST and ILW)*

* The phytotron option is not available for thermostatic cabinets with a monoblock, i.e. ST 500 M, ST 700 M, ST 1200 M and ST 1450 M.

The phytotron (FIT) function enables the simulation of day and night: duration and smooth regulation of light intensity.

Phytotron version with illumination panels

Before you start configuration of light parameters, turn on the illumination panel that will be used and configured (applies to devices with the FIT version in the form of lighting panels). Press icon of the main menu ,

and then the light icon  (Figure 26).

Figure 26 Switching on / off the illumination panels



Depending on the capacity of the equipment, 1, 2 or 3 illumination panels can be installed. With several lighting panels, it is not necessary to use them all at the same time. To avoid alarms related to illumination panels which will be removed, select only those that will be used (Figure 26). For example, when the lighting panel will not be used and has been removed from the device, it must be turned off (uncheck the box next to the shelf number). When the illumination panel will be used and inserted into the device, turn it on (mark the box next to the shelf number).

Figure 27 Turning on/off the illumination panel

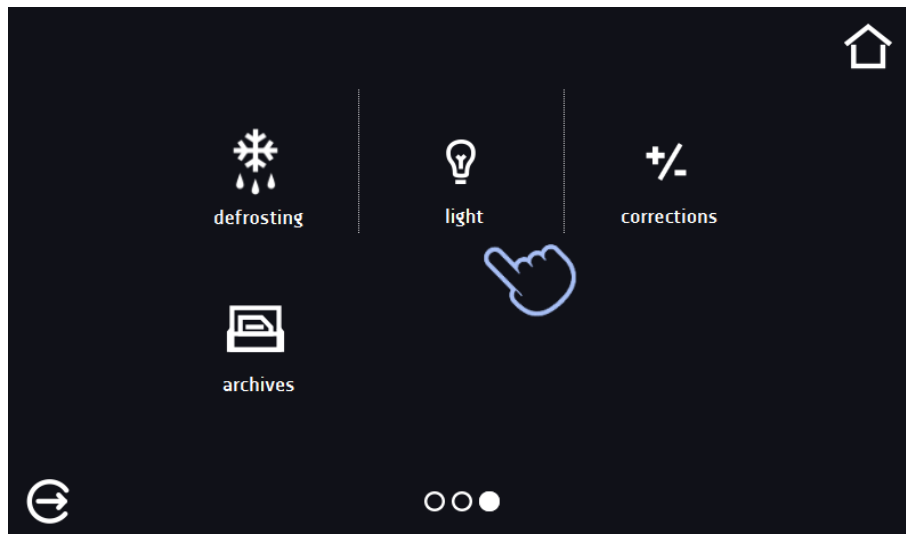

Confirms changes



Cancel the entered changes

6.7.3.1. Equipment with one illumination zone

Equipment with one illumination zone can have fluorescent lamps mounted in: side walls/ doors/ walls and doors/ lighting panel(s). The device with lighting panels has the option of controlling each panel individually, see Section 6.7.3.2. The light intensity can be set every 1%. To set the light intensity, check the "light" box and then enter the value (Figure 28).

Figure 28 Setting the light intensity value for one illumination zone



6.7.3.2. Equipment with few independently controlled illumination zones (optionally)

The phytotron version with illumination panels can be equipped with an option (additionally paid) allowing independent control of each lighting panel. To set the light intensity in each panel separately:

1. Click the light bulb icon to set the light for each lighting panel in a separate window.
2. To turn on the light in the segment, select the check box (Figure 29) and then set the intensity value for each turned on panel (Figure 30).

Figure 29 Turning on the light

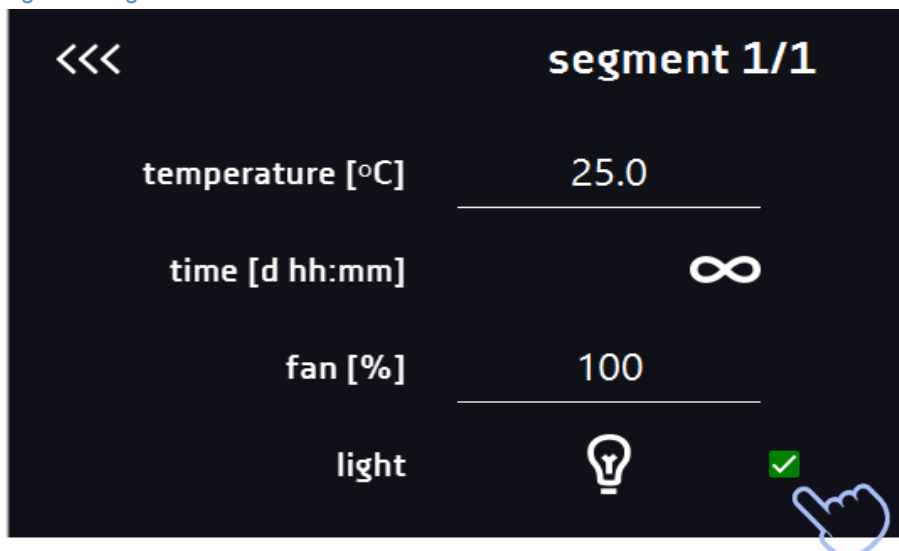

Figure 30 Setting the light intensity in active panels



Confirms and saves the changes



Cancels the entered changes in the segments and goes to program parameters

6.7.4. Summary of segments

In the segments summary (Figure 31) all segments can be seen along with introduced parameters:

- number of segments,
- temperature, duration time, target time of reaching temperature of a given segment,
- fan efficiency (for ST 1-6, CHL 1-6, ILW).

Figure 31 The summary of the segment

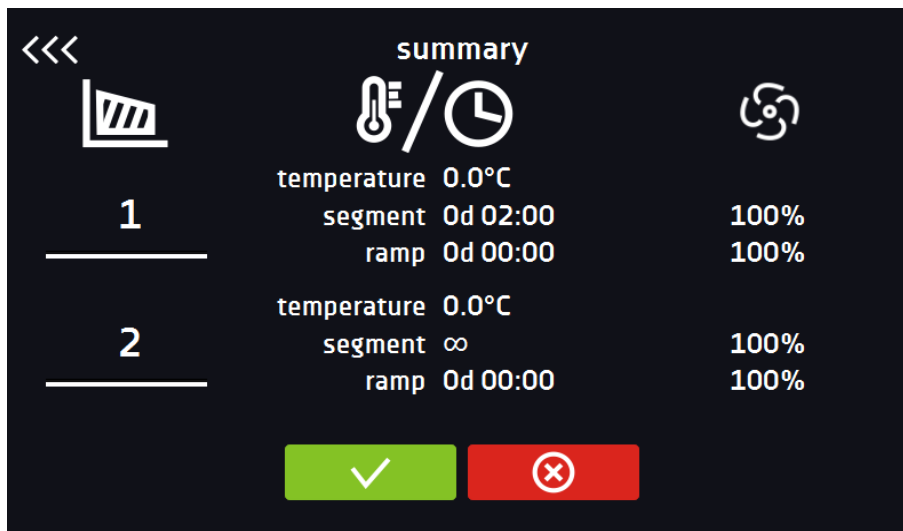

Confirms and saves the changes



Cancels the entered changes in the segments and goes to program parameters



With more parameters, the window can be scrolled up and down.

6.7.5. Protection class

The device is equipped with sample protection – temperature protection which is carried out on the basis of the temperature value measured by an independent temperature sensor, the so-called security sensor. The main aim of sample protection is the protection against uncontrolled rise or fall of temperature. When activated, the relay disconnects the heating / cooling circuit.

Figure 32 Confirmation of protection alarm

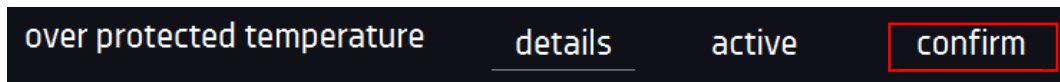

Class 3.2 according to DIN 12880 – the user programs the protection temperature and once it's exceeded, the compressor is cut off. When the temperature returns to the allowed range, the device resumes operation (in ST and CHL).

Class 3.3 according to DIN 12880 – over and under temperature protection – combination of classes 3.1 and 3.2. - the user programs the protection temperature (over and under) and once it's exceeded, the heaters or compressor will be cut off. When the temperature returns to the allowed range, the device resumes operation (in ILW).

The set temperature in the segment cannot be higher than the over temperature protection minus 2°C, e.g. the over temperature protection is 50°C, therefore the maximum set temperature in the segment that can be set is 48°C.

6.7.6. Temperature protection

The temperature protection value for protection class 3.1 and higher is:

- bottom protection temperature: maximum +20°C
- upper protection temperature: minimum + 30°C

6.7.7. Priority

Can be set in terms of:

Parameters:

In the program without ramp – the device starts the countdown of the segment time when the set temperature is reached.

In the program with ramp – first, the device counts down the time of the ramp and then proceeds to the segment countdown when the set temperature is reached. Regardless of whether the time of ramp elapsed.



It may happen that the device failed to reach the set temperature within the set time because the reaching time was too short. In such situation the reaching time will be prolonged and the segment's time countdown will start when the set temperature will be reached.

Time:

In the program without ramp – the device starts counting down the segment time when the program is started. Regardless of whether the temperature has been reached.

In the program with ramp – first, the device counts down the ramp time and after its expiry it proceeds to the countdown of the segment time. Regardless of whether the temperature has been reached.



It may happen that the time of reaching was too short and the device failed to reach the set temperature within the set time. Then the countdown of the segment time will start before reaching the set temperature. Thus, the actual time of device operating in the set temperature will be shortened.

6.7.8. Loop

The option is available if the number of segments is equal to 2 or more (maximum 100). When the program finishes the last segment, the device starts the program again from the first segment. You can define if the program should be carried out once (loop: 1) or multiple times (loop: 2 to 255). In order to set the program to be carried out continuously, tick the „∞“ option. If the time of the last segment is set to infinity, it will be treated as infinite only in the last cycle. In other cycles it will be treated as 0.

Example:

Loop:3

segment1: temp. 10°C, time 2 h

segment2: temp. 30°C, time 2 h,

segment3: temp. 40°C, time „∞“

The device will run segment1 and segment2 three times and then will go to segment3 which will last indefinitely.

6.7.9. Defrosting program (only for CHL 1-6, CHL 500, CHL 700, CHL 1200, CHL 1450)^{1,2}

¹ does not apply to refrigerators with monoblock: CHL 500 M, CHL 700 M, CHL 1200 M, CHL 1450 M

² does not apply to refrigerators with automatic defrosting function (PLUS function)

CHL laboratory refrigerators (without PLUS - automatic defrosting function) have a special defrosting program ([Figure 32](#)). It appears on the programs list available in the main screen after pressing the button . Defrosting is the temporary activation of heaters, which are intended to defrost a coating of ice or frost accumulated on the walls of the chamber during normal use. During defrosting inside the chamber, the temperature rises to around + 30°C and the process lasts 30 minutes.

If the defrosting function is active, you will see the icon  on the main screen. You can stop defrosting at any time by pressing the button .

In ST thermostatic cabinets and ILW cooled incubators in which the sample is stored at a temperature of $\leq 5^{\circ}\text{C}$, ice or frost on the evaporator can be thawed by raising the temperature in the chamber to approx. + 30°C and keeping it for 30 min (you can create a program with the given parameters, which will be visible on the program list and run it if necessary to defrost).



When the defrosting has finished, you need to wipe out the chamber. This will reduce the risk of quick frosting of the chamber.

Figure 33 Defrosting program

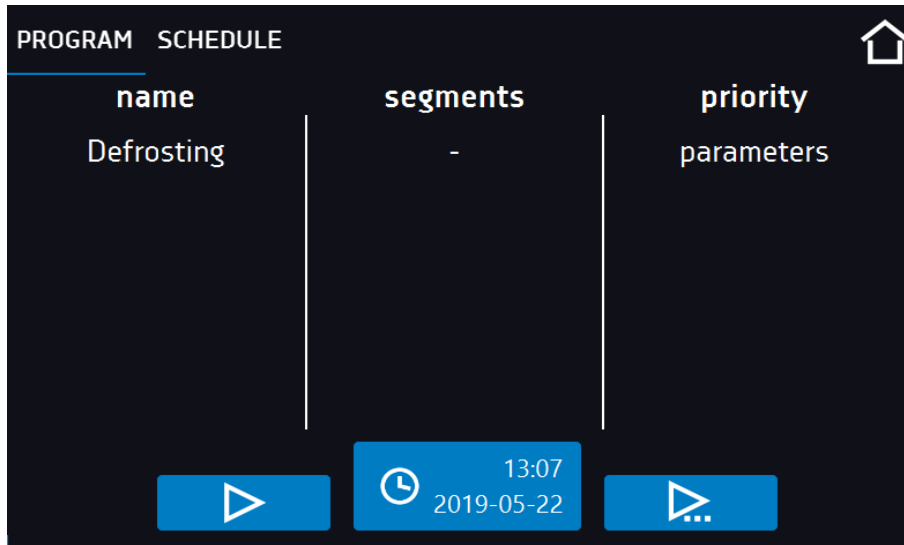

6.8. Starting the program

The created program can be started in two ways:

6.8.1. The first way



- Go to the main menu  and press the icon „programs”  (Figure 34).
- Then select the program you want to activate and press „start” button  (Figure 35).

Figure 34 Main menu

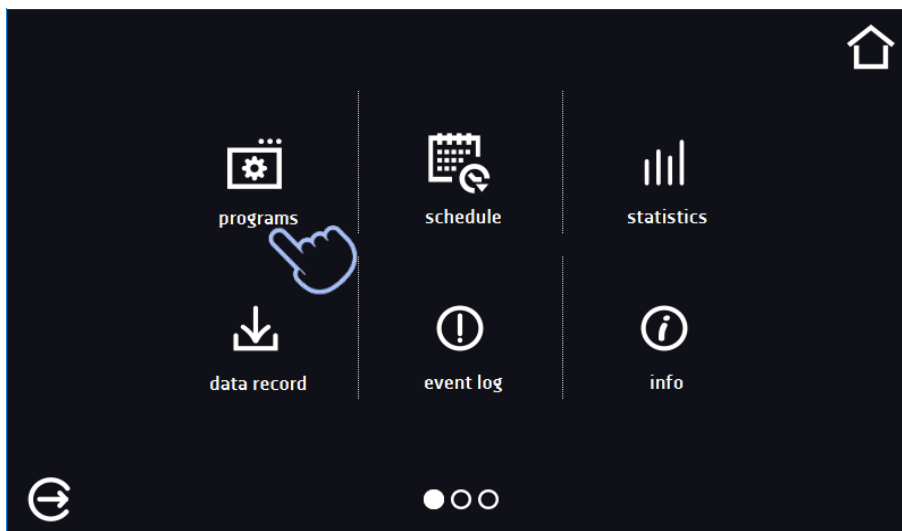
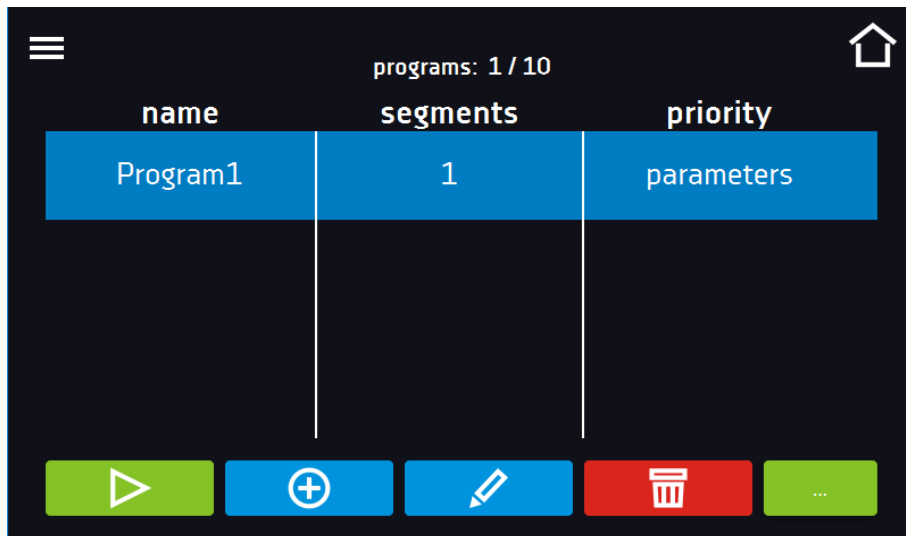

Figure 35 Program management menu







If the program is running, the symbol  appears next to the program name on the list. The symbol  means that the program has been edited, but the changes have not been confirmed (Figure 36).

Figure 36 List of programs with the selected status

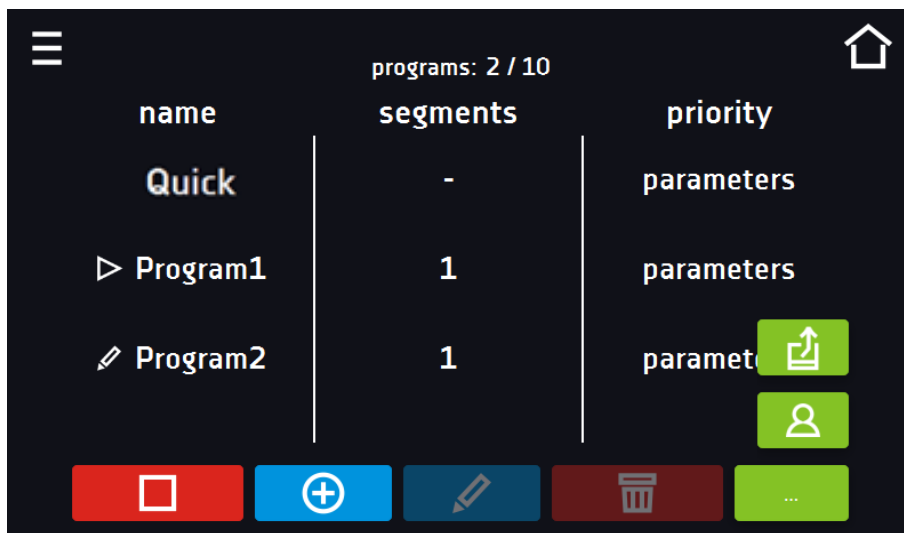

6.8.2. The second way

- In the main screen press the icon in the upper right corner  (Figure 37).
- In the upper left corner press „PROGRAM“
- Select the program you want to start (Figure 38). You have two additional options to start the program:



Immediate start of the program.



Scheduled program start according to the set date and time.

Figure 37 Main screen

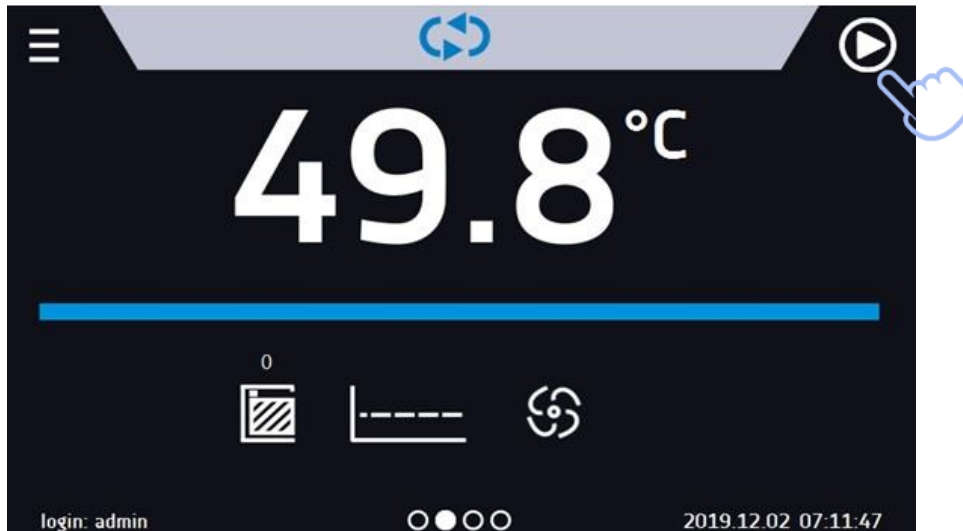
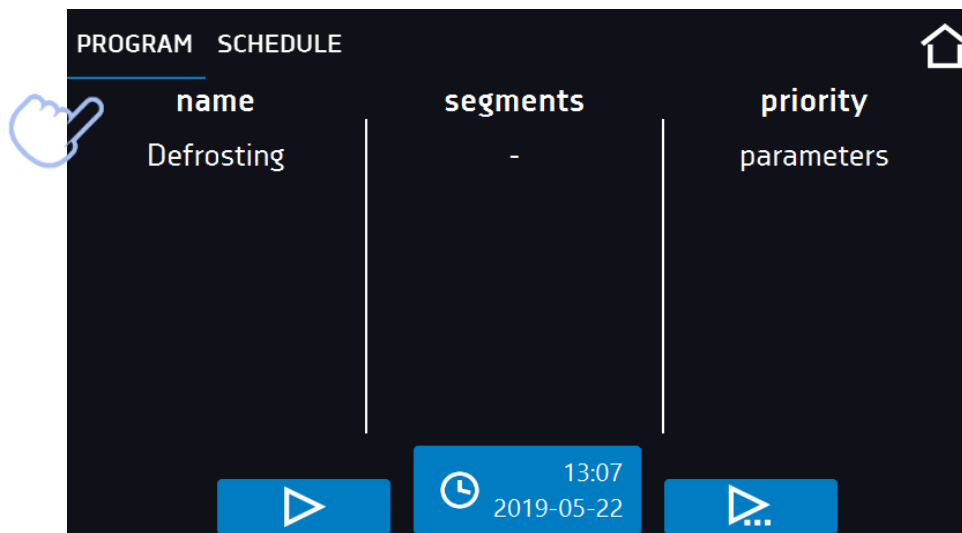



Figure 38 Selection and launch of the program



 A delayed start of backdated program is possible (up to 7 days back). This is possible for the programs with time priority. Program segments that would last from the back date to the current date will be skipped.



If the program is running, the symbol  appears next to the program name on the list.

6.9. Quick change of parameters

 You cannot make a quick change (of time / temperature) in a running program that belongs to another user. Information about the program owner can be found in the information panel (lower left corner).

 Although the ramp time has been included in the program, the Quick Change of parameters will take place immediately while the temperature is being reached.

6.9.1. Quick change of set temperature

In order to quickly change the value of set temperature of a running program, press the icon  in the main screen (Figure 39). The value of the temperature should be selected by scrolling the list up or down (Figure 40). Click  to confirm the change.

The temperature can't be higher than the over temperature protection -2°C and lower than the under temperature protection +2°C.



Figure 39 Quick change of set temperature

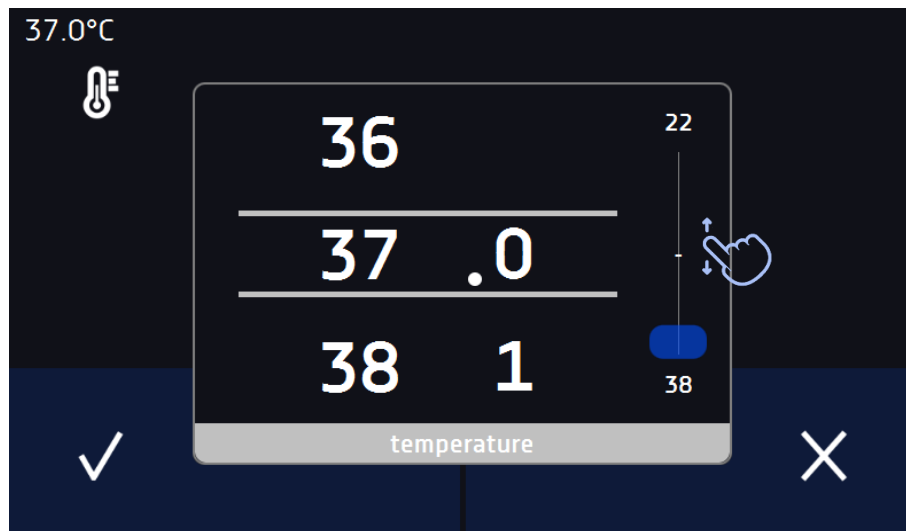

Figure 40 Quick temperature change - setting the value



6.9.2. Quick change of set time

In order to quickly change the duration time of a running program, press the icon  in the main screen (Figure 41). Select the number of days, hours and minutes by scrolling the list up or down (Figure 42). Click  to confirm the change. To set the continuous work press .

To change the way of displaying the time, press::



– to display the elapsed time



– to display the remaining time

To change only the way of displaying, you do not have to confirm it by .

Figure 41 Quick change of set time

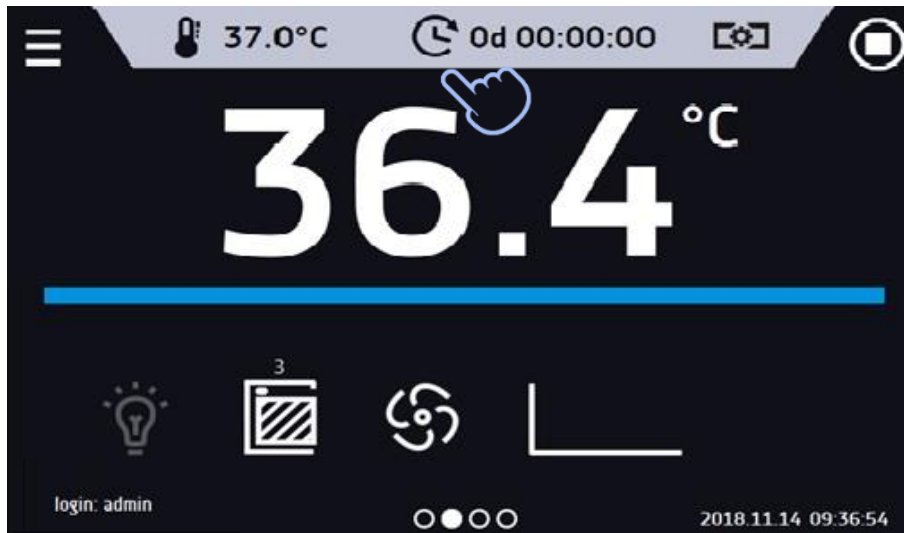
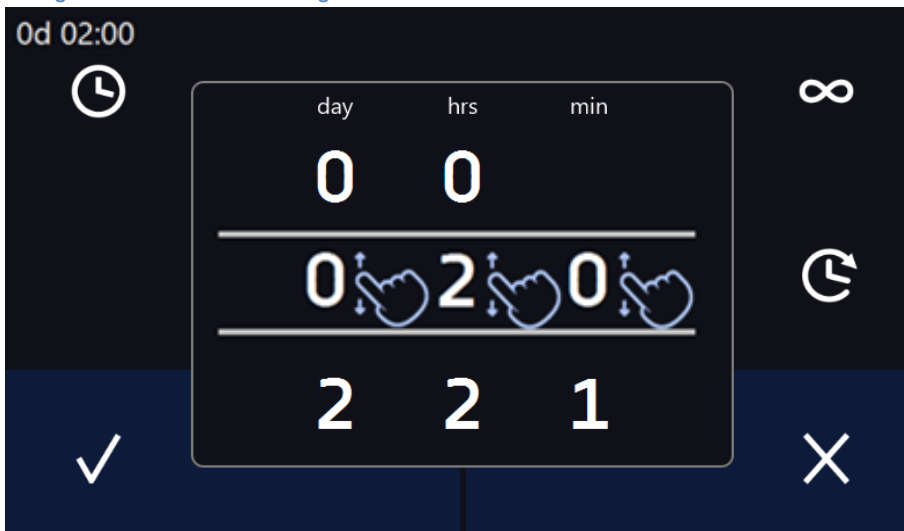

Figure 42 Quick change of the set time - setting the value



6.9.3. Quick change of fan efficiency (only for ILW, ST 1-6, CHL 1-6)



In order to quickly change the fan efficiency, press the icon  in the main screen (*Figure 43*). The value should be selected by scrolling the list up or down (*Figure 44*). Press  to confirm the change.

Figure 43 Quick change of fan performance - selection

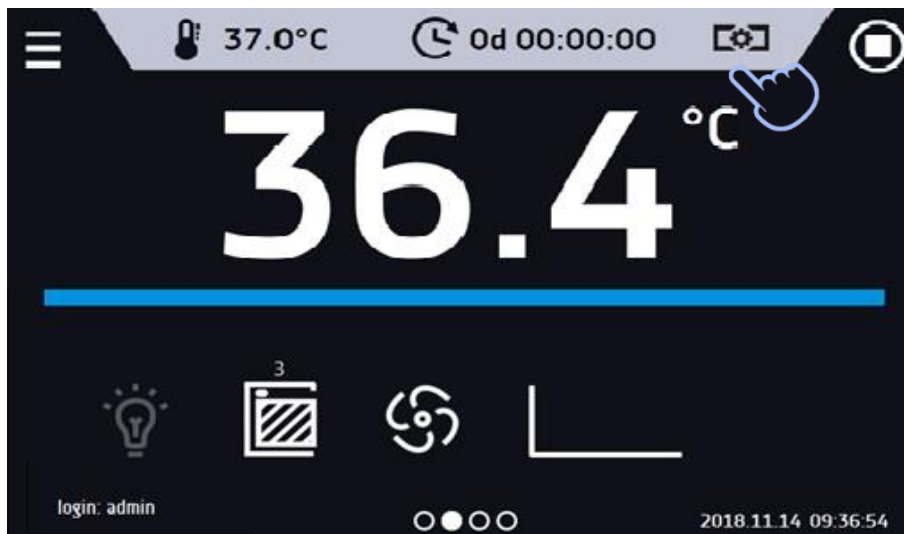
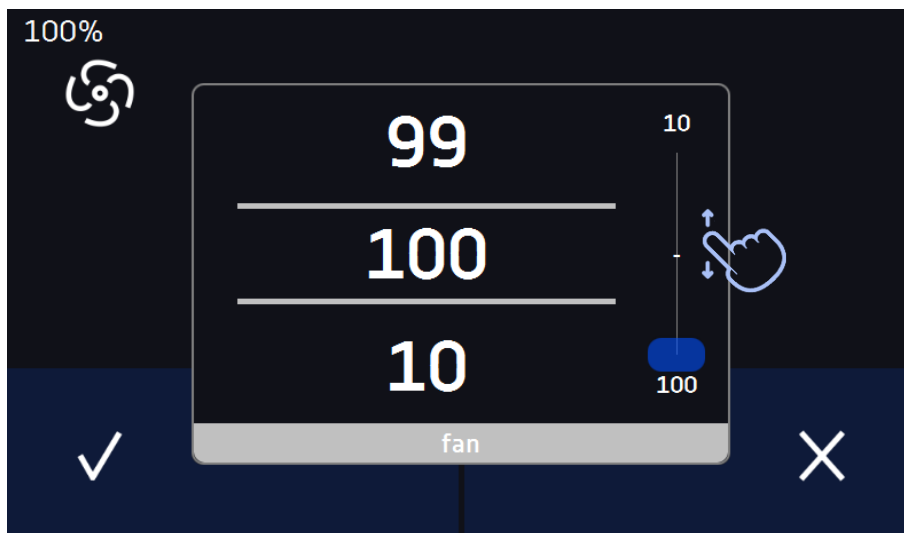



Figure 44 Quick change of fan performance - setting values



6.10. Schedules

The option allows creating a list of programs to be implemented in a given time. You can create several independent schedules. The schedules window contains a list of all created schedules of the logged-in user (Figure 45).

	Before you start creating a schedule, you must create programs that you want to include in it.
---	--

On the upper part of the screen there is information about the number of created schedules / the maximum number of schedules to be created (1/10).

Figure 45 List of schedules

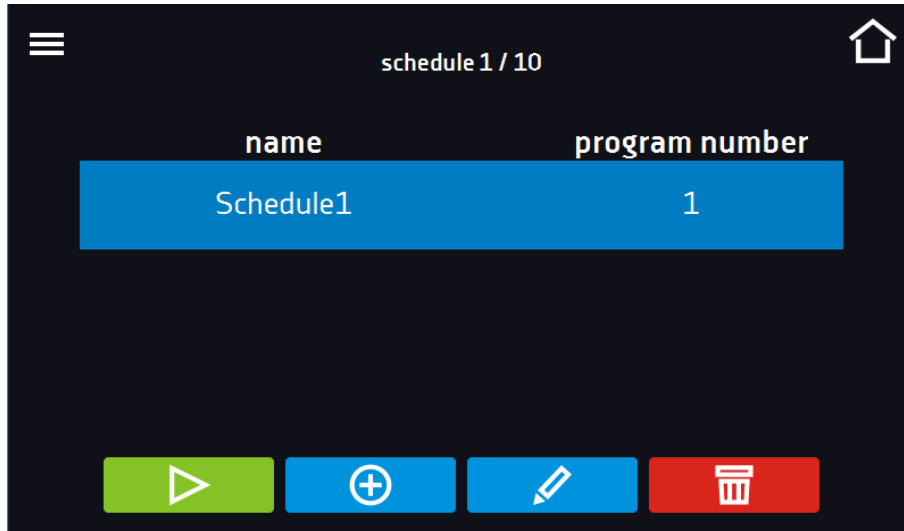

Start the schedule



Stop the schedule



Add the schedule



Edit the schedule



Delete the schedule

6.10.1. **Creating / editing a schedule**









To create / edit a schedule, press the button  or . The panel with schedule parameters will appear on the screen (Figure 46). Press "Schedule" and use the keypad to enter the schedule name. The schedule may consist of up to 10 programs.

Figure 46 Creating / editing a schedule

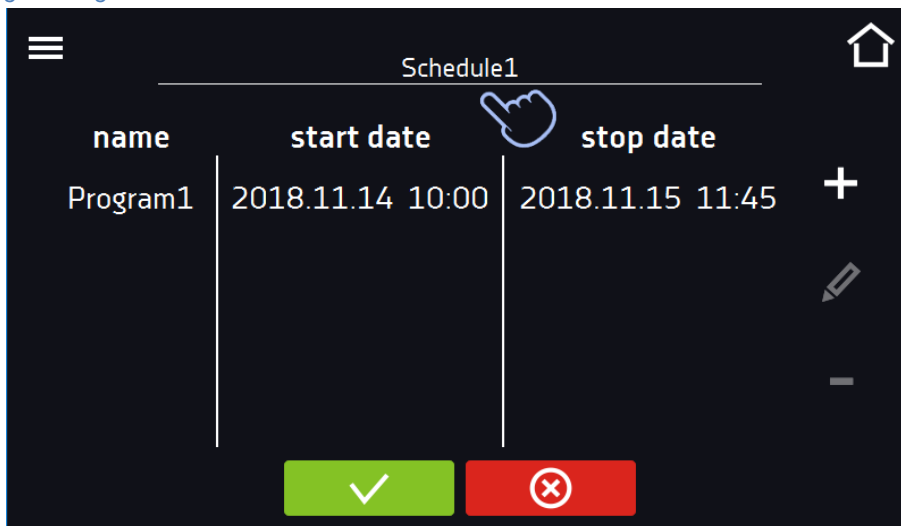

-  Add a new program to the queue (program must be previously created)
-  Edit and make changes to the selected position
-  Delete the selected position from the list
-  Save the schedule
-  Cancel introduced changes



After pressing  (Figure 46) or  a window appears allowing you to select the program and the date and time of its start and end (Figure 47).

Figure 46 Adding a program to the schedule



Select a program from the drop-down list and press on the field next to the inscription "program" (Figure 48). Information about the selected program will be displayed (Figure 49): number of segments, number of cycles, priority, temperature protection, upper protection, lower protection. This is only a preview of the parameters - it is not possible to change them in this window.

Figure 48 Selection of the program

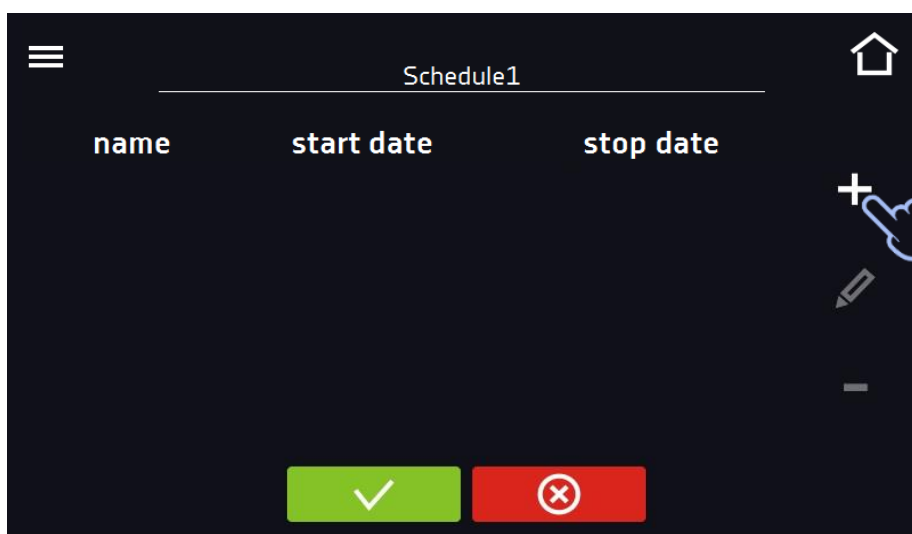
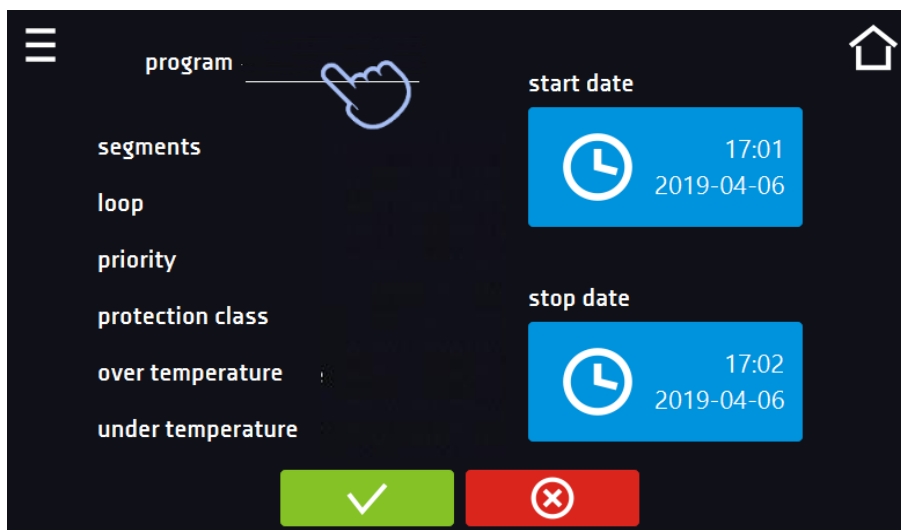

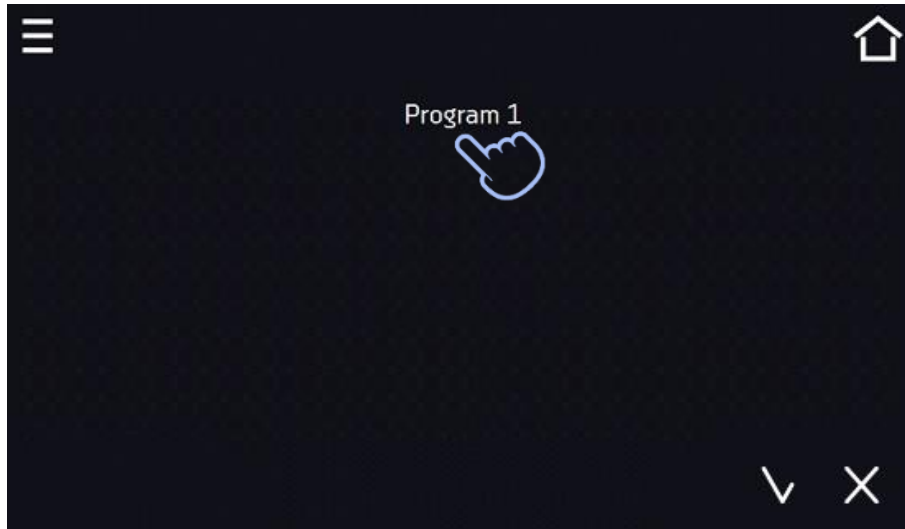
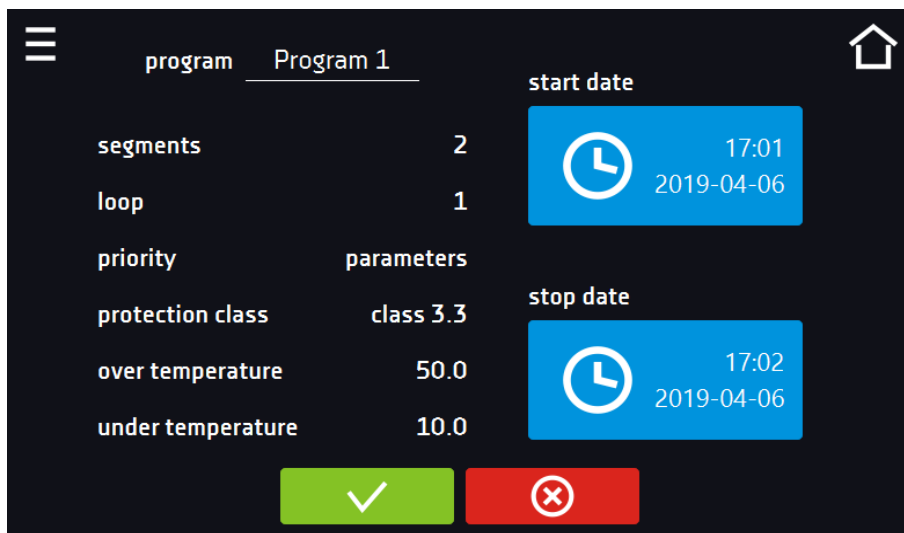
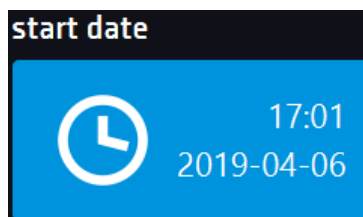

Figure 49 Information about the program



Press the 'start date' field and then set the date and time of program start.



Press the 'stop date' field and then set the date and time of the program end.

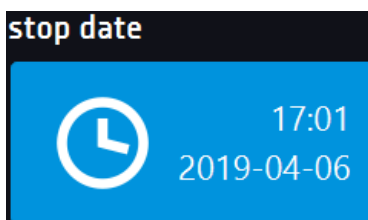



You can assign up to 10 programs to one schedule. In total you can create ten schedules.

When creating a schedule, consider the following restrictions:

- the start time of the first program on the list cannot be earlier than the current date and time,
- the start time of the next program on the list cannot be earlier than the end time of the previous program,
- the program end time cannot be later than the start time of the next program,
- the end time of the next program does not have to coincide with the start time of the next one, there may be a break between them,
- if the program is not fully completed (due to setting a too short time of a schedule), it will be interrupted.



When choosing time intervals, consider whether they are long enough for the selected program to be implemented. The duration of the program can be affected by: ambient conditions, samples and the program carried out immediately before it.

6.10.2. Starting a schedule

The schedule can be started in two ways:

6.10.2.1. The first way



- Press the icon of the main menu  and then press the icon „schedule“  (Figure 50).
- Then select the schedule you want to activate and press the start button.  (Figure 51).

Figure 50 Main menu

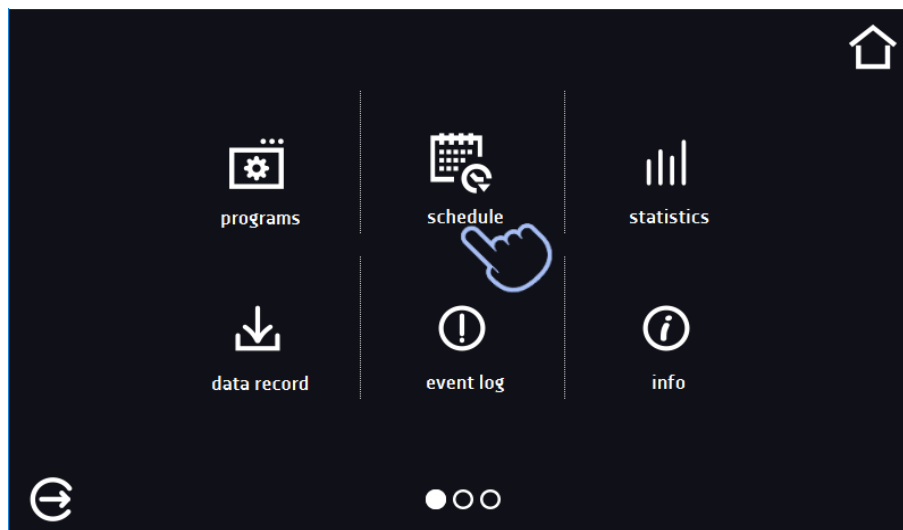
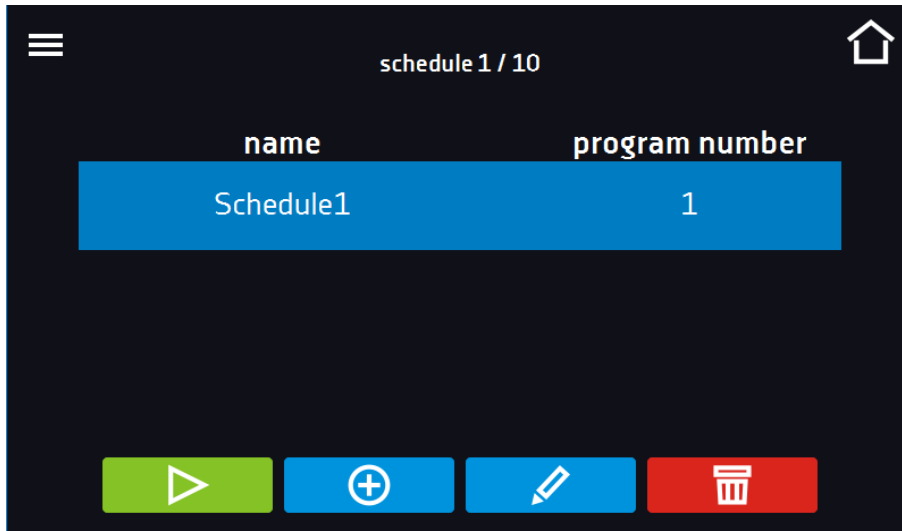



Figure 51 List of schedules



Start the schedule

6.10.2.2. The second way

- In the main screen press the icon  (Figure 52), then press the SCHEDULE inscription. The schedule selection window will be displayed (Figure 53).
- Then select the schedule you want to activate and press the button .

 Please note that it is not possible to run a schedule in which all parameters refer to the past time.



Figure 52 Main screen



Figure 53 Selection of the schedule

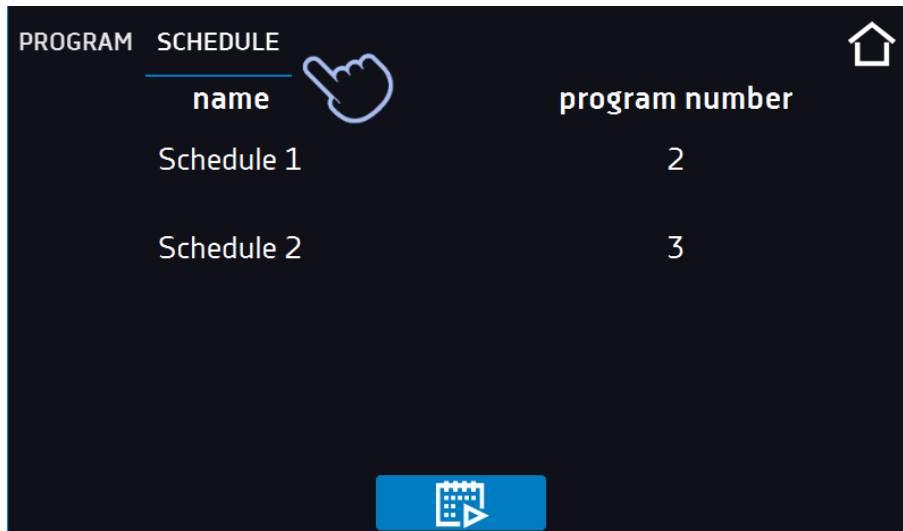

6.11. Statistics

Go to the main menu  and press the icon . This panel (Figure 54) displays statistics of the currently running program or program that has ended. Statistics are calculated separately for each segment. Data logging for calculation starts after 30 seconds from reaching the set temperature in the segment. Further data is registered every 1 minute. The following information is available:

- **set temperature [°C]** – set temperature in the segment,
- **minimum temperature [°C]** – the lowest recorded temperature,
- **maximum temperature [°C]** – the highest recorded temperature,
- **average temperature [°C]** – average temperature,
- **segment** – status of the segment:
 - **in progress** – currently running segment (data is being constantly updated),
 - **finished** – the segment has been completed,
 - **interrupted** – the segment was interrupted by the User before the set time has elapsed,
- **segment 1/2** – the number of the currently overviewing segment / number of the currently performed or completed segment. Navigating between the segments is done by swiping your finger up or down.
- **loop 1/1** – the number of the currently overviewing cycle / number of the currently performed or completed cycle. Navigating between the cycles is done by swiping your finger left or right.



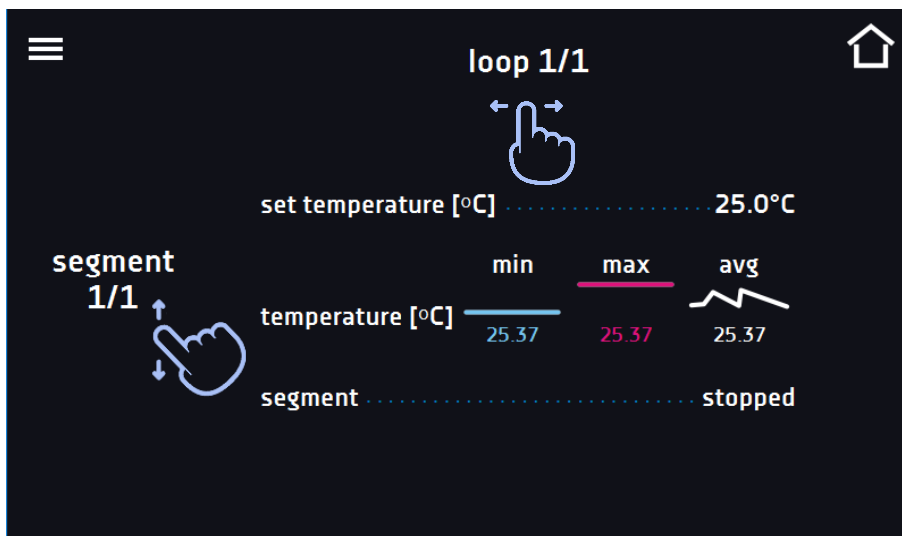

You cannot overview the segment / cycle data that has not started yet.

Figure 54 Statistics



6.12. Data record

Go to the main menu  and press the icon . Data record window (Figure 54) contains the following information:

- time and date of sample registration [date],
- temperature value measured with the main sensor in the chamber [temp.].

It is possible to register 10 000 data records for the max period of 12 months. If all the memory cells are full, the oldest ones are overwritten. The data appears in the table in the order they were added, not in chronological order by the date. The most recently added record is at the top. The samples are only registered when the program is running. The frequency of registration depends on the program parameters settings.



When opening the data record, all data is downloaded. If the data download is interrupted by the user, press  to continue downloading of the rest of the data.

Figure 55 Data record





Press to continue downloading data

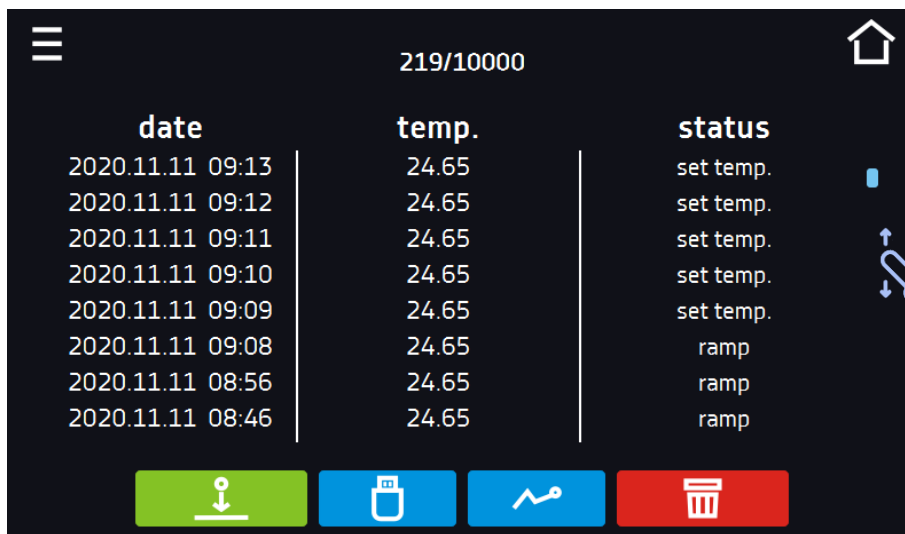

Recording data onto the USB flash drive. .csv files are available - separated by semicolon when opening e.g. with a spreadsheet, .plx - opening with the Lab Desk application



Before removing the USB flash drive from the USB port, it must be unmounted, see [Section 5.8](#).



Displaying data as a graph, see [Section 6.12.1](#).



Deleting data. Users with Super Admin privileges can delete all data, including those registered by other users ([Figure 55](#)).

If there is a lot of data, a progress bar appears on the display:

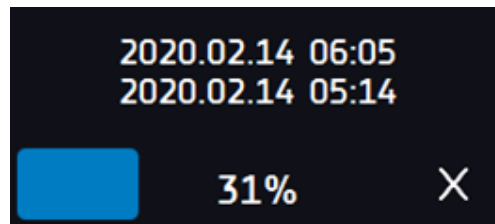
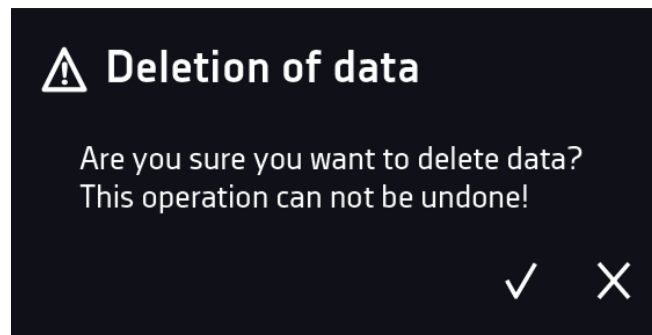

Figure 56 Deleting data



6.12.1. Graph

A graph can be generated from the data stored in the data register ([Figure 57](#)). The time during which the graph opens depends on the number of saved samples data. If the unit is equipped with additional sensors, press the selected graph twice.

Figure 57 Temperature graph

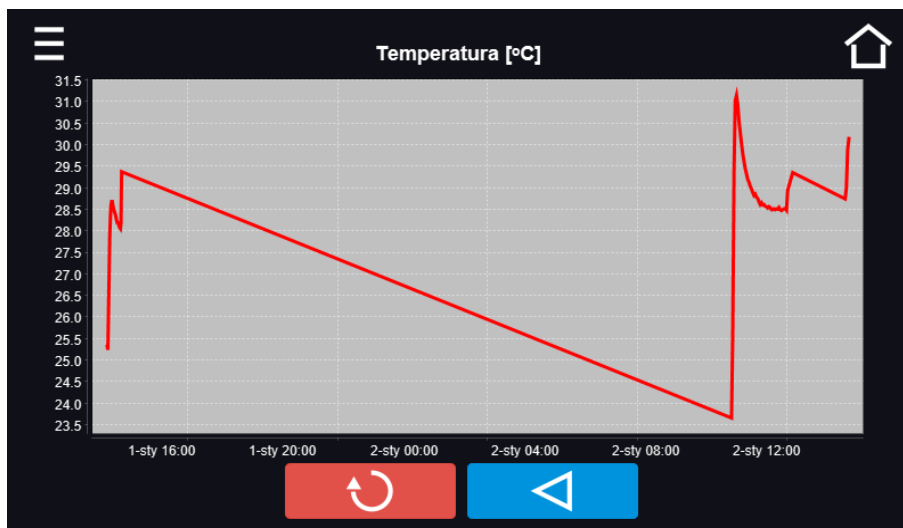



Returns to displaying the entire chart (undo all magnifications) / returns to the list of charts.



Returns to data register



The opening time of the chart depends on the number of saved data samples. The greater the number of saved samples, the longer this window will open.

You can enlarge a fragment of the chart. Press the graph anywhere and drag to the right and down simultaneously (*Figure 58*) - enlarge in the same way as it is done on a smartphone. Swipe left to return the chart to normal size.

Figure 58 Enlarging a part of the chart

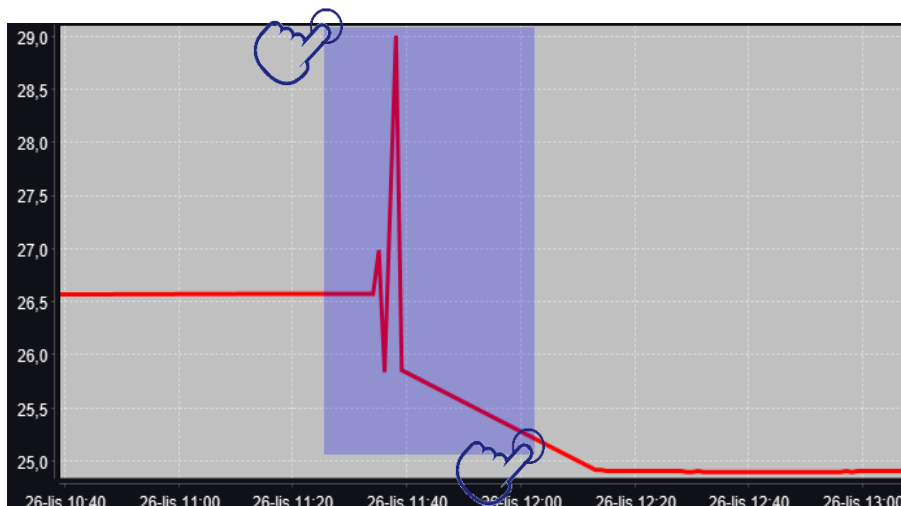

6.12.2. Data storage directly on a USB flash drive

The saved data (temperature and / or humidity, date and time) can be saved directly on a connected USB flash drive. To do this, enable the option of saving data, see point 6.16 and *Figure 62*. The USB flash drive must be connected to the USB socket located on the front of the equipment.

The date / time, temperature of the sensor installed in the chamber and indications of additional sensors in the unit (humidity, additional temperature sensor) are saved to the file. The frequency of saving to the file is equal to the frequency of saving the data in the register set in the program, see section 6.7.1. *Creating / editing a program* (saving interval to the data register). Few comments can be found below:

- saving to the file takes place only when the program is running,
- data register is continued after power is restored,
- during registration, the USB flash drive can be removed but it is necessary to unmount it in the main window on the upper menu bar, see section 5.9. *USB port*,
- registration is continued after reinserting the USB flash drive,
- a folder with the name consistent with the serial number of the device is created on the flash drive, all files are saved in it. The files are saved in the csv format (separated by semicolons), which can be read in a spreadsheet or notebook

	A	B	C
1	date	temp.	status
2			
3	23.03.2022 11:06	25.04°C	wait
4	23.03.2022 11:07	25.04°C	ramp
5	23.03.2022 11:08	25.04°C	ramp
6			

- the current measurement is saved to a file named measurements.csv,
- if the size of the current file exceeds 513 kB or the calendar month is changed, the current file is named in the format yyyy-mm_ measurements_0.csv, where 0 means the file number in the month, e.g. 2021-05_ measurements_0.csv

6.13. Event log

Data available for the following users (see Section 6.15 Users):

- **Super Admin** who can overview, download to USB flash drive and delete all data,
- **Admin** who can overview, download to USB flash drive all data,
- **User** who can only overview all data.



Go to the main menu  and press the icon . The window displays information about registered events, alarms and errors.

Figure 59 Event log



date	name	code
2020.11.10 21:04	<i>i</i> Program Stop	2.01.0.1.008
2020.11.10 21:03	<i>i</i> Program Start	2.01.0.1.007
2020.11.10 21:03	<i>i</i> Program Stop	2.01.0.1.008
2020.11.10 21:03	<i>i</i> Program Start	2.01.0.1.007
2020.11.10 21:03	<i>i</i> Program Stop	2.01.0.1.008
2020.11.10 21:03	<i>i</i> Program Start	2.01.0.1.007
2020.11.10 14:13	<i>i</i> Program saved	2.01.0.1.022
2020.11.10 14:13	<i>i</i> Program deleted	2.01.0.1.023
2020.11.10 14:12	<i>i</i> Program updated	2.01.0.1.024

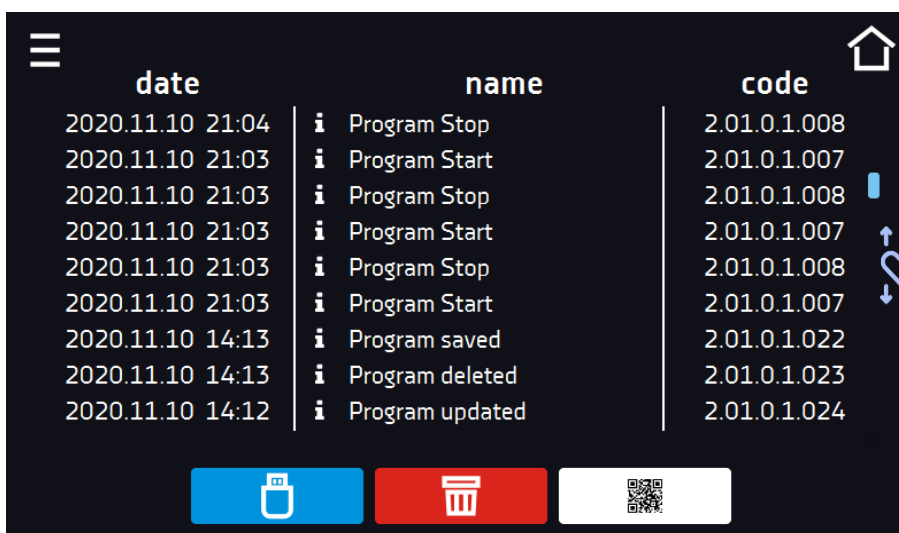

Recording data onto the USB flash drive. .csv files are available - separated by semicolon when opening e.g. with a spreadsheet, .plx - opening with the LabDesk application



Before removing the USB flash drive from the USB port, it must be unmounted, see Section 5.8.



Deleting data



QR code – opens smart4lab.eu (in the "Support" tab there are explanations of some of the information appearing in the event log). Press the symbol  and enlarge the code QR, and then scan it with your smartphone

Figure 60 QR code



The events in the event log are sorted chronologically. However, it may happen that the event "Program restarted" will not be displayed according to the chronology but the date and time of the event will be correct. This is not an error.

Before removing the USB flash drive from the USB port, it must be unmounted, see [Section 5.8](#).

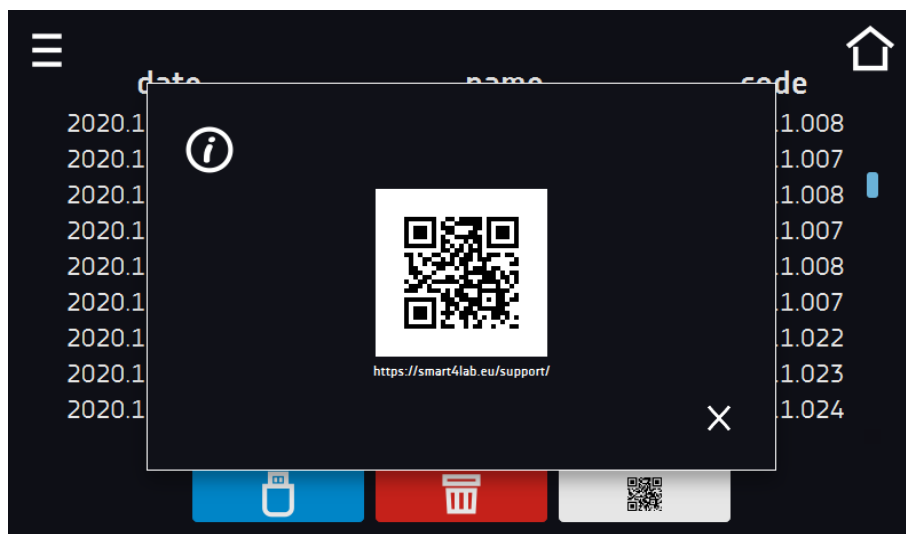
Information signs in the event log:

- Information event
- Message entered by the user
- Alarm event
- Error
- Warning

Possible events:

Program Start	starting the program
Program Stop	stopping the program
Program Edit	changing the program parameters
Program End	program is completed
DeviceOn	the device is switched on (on the main switch)
DeviceOff	the device is switched off (on the main switch)
Door opened	the door is opened
Open door alarm start	open door alarm has been activated
Door closed	the door is closed
Open door alarm stop	open door alarm has been deactivated
Program Restarted	program has been resumed after power failure
Under Protection Start	under-temperature protection has been activated
Under Protection Stop	under-temperature protection has been deactivated
Upper temp. alarm Start	over- temperature protection has been activated

Upper temp. alarm End	over- temperature protection has been deactivated
Date/time change	date/time has been changed
Lower temp. alarm Start	activation of the alarm of exceeding the temperature below the set temperature
Lower temp. alarm End	deactivation of the alarm of exceeding the temperature below the set temperature
Upper temp. alarm Start	activation of the alarm of exceeding the temperature above the set temperature
Upper temp. alarm End	deactivation of the alarm of exceeding the temperature above the set temperature
Deleted Measurement	user measurements have been deleted
Deleted All Measurement	all measurements have been deleted
User added	new user has been added
User updated	user has been changed
User deleted	user has been deleted
Program saved	new program has been saved
Program deleted	program has been deleted
Program updated	program has been updated
Time Zone Changed	in the time settings the time zone has been changed
Temperature Correction Changed	main sensor temperature correction has been changed
Emergency stop of the program	the program has been automatically stopped – there was a situation that didn't allow the program to be continued. PLEASE CONTACT THE SERVICE
Defrosting Start	starting the defrosting process
Defrosting Stop	stopping the defrosting process
Power Fail Start	power failure / device fuse blown out.
Power Fail Stop	power resumed, returned to maintain program parameters
User login	date and time of login
User logout	date and time of logout



Quick note

To view message details, click **User Message**. In this window (*Figure 61*) you can see the content of the message, the name of the user who entered it and the name of the program during which the message was written.

Figure 61 Details of user's message

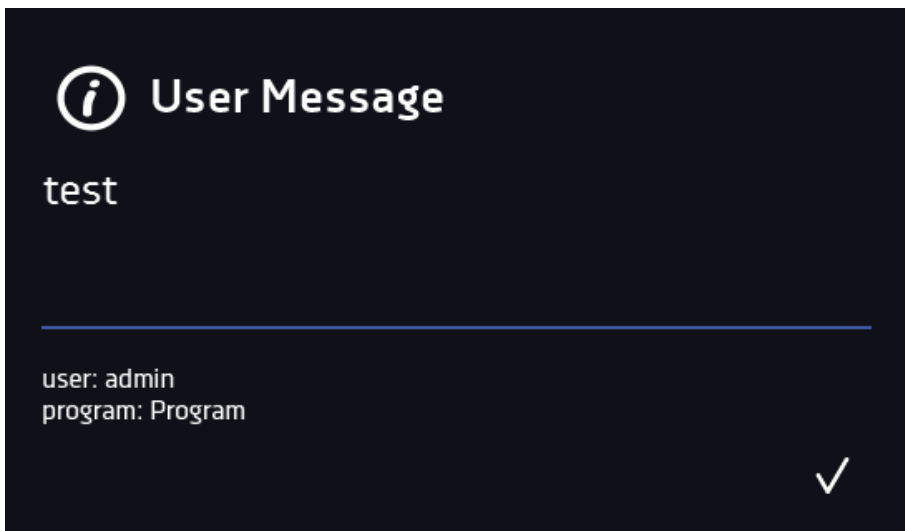



6.14. Info

Go to the main menu  and press the icon . The panel contains the following information:

- name of device,
- temperature range of the device,
- serial number of the device,
- Software version,
- manufacturer's address,
- manufacturer's website,
- QR code.

Figure 62 Info window (example)



Press icon  to save the "Download" folder (with instruction manual) on the USB flash drive. After inserting the flash drive into USB port wait few seconds until the information "Flashdrive connected" will appear on the display - for more information go to the [Section 6.1](#). Press the icon  to write the service data on the USB flash drive – contact the service for more information.

Press  to go to the main screen. If a USB flash drive is connected to the device, when entering the "Info" panel, a proposal to save configuration file will appear ([Figure 63](#)). This file is used to create an offline program in the Lab Desk application.



Figure 63 Saving configuration file





Before removing the USB flash drive from the USB port, it must be unmounted, see [Section 5.8](#).

6.15. Users

Go to the main menu  and press the icon . In this panel ([Figure 64](#)) you can add a new user, edit an existing one or delete it.

[Figure 64](#) Users list

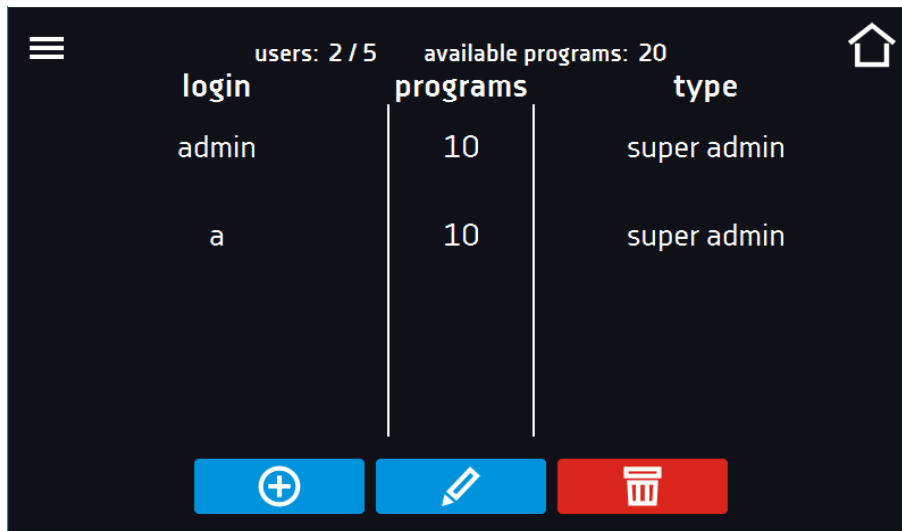

login	programs	type
admin	10	super admin
a	10	super admin



Adding a new user



Editing selected user



Deleting selected user - his programs and data register will be deleted with the user.

At the top of the screen ([Figure 64](#)) you can see information about:

- **users:** number of created users / total number of users to create (users 2/5),
- **available programs:** the number of free programs to be assigned to users.

6.15.1. **Creating / editing a user**

To add or change user settings, press the button  or , a panel with user data will be displayed ([Figure 65](#)).

You have to enter:

- **login** – user name,
- **password** – account password,
- **password confirmation** – you must enter the password again to confirm it,
- **type** – account type (Super Admin , Admin, User), for more information see [Section 6.15.2.](#),
- **programs limit** – number of programs that can be created by the user / number of available programs (it's not possible to set a limit to the User).

Figure 65 Editing a user



Confirms and saves the user



Cancels introduced changes and returns to the users list



The device can have maximum 5 users. There are 40 programs available which can be freely distributed among users.

6.15.2. Account types and their limits

Three different types of users (accounts) are available: Super Admin, Admin, User. Each user has their rights and limitations described below in the [table 1](#).

Table 1. Right and limitations of the users.

	Super Admin	Admin	User
Creating programs	✓	✓	X
Editing programs	✓	✓	X
Stopping your own program	✓	✓	✓
Stopping a program of another user	✓	X	X
Quick program	✓	✓	X
Quick change of set time	✓	✓	X
Quick change of set temperature	✓	✓	X
Assigning a program to a user of the user type	✓	✓	X
Creating a schedule	✓	✓	X
Editing a schedule	✓	✓	X
Defrost control	✓	X	X
Management of the illumination shelves in the unit (FIT version)	✓	X	X
Setting temperature measurement parameters	✓	X	X
Temperature value correction	✓	X	X
Setting the alarms	✓	X	X
Temporarily silencing the alarms	✓	✓	✓
Enabling / disabling the sound	✓	X	X
Saving a Quick Note	✓	✓	✓

Creating users accounts	✓	X	X
Changing user's settings	✓	X	X
Changing equipment's name	✓	X	X
Setting a time zone	✓	X	X
Changing the language	✓	X	X
Setting the automatic logout time	✓	X	X
System information preview	✓	✓	✓
Statistics preview	✓	✓	✓
WiFi settings	✓	X	X
LAN settings	✓	X	X
Setting e-mail reports	✓	X	X
Access to the archive	✓	X	X
Events preview	✓	✓	✓
Deleting events	✓	X	X
Copying data to a pendrive	✓	✓	X
Data preview	✓	✓	✓
Copying data to a pendrive	✓	✓	✓
Displaying data as a graph	✓	✓	✓
Deleting your own data	✓	✓	✓
Deleting all data	✓	X	X
Reseting the open door counter	✓	X	X

Super Admin account

The Super Admin account has no limits. Has access to the program management menu and to the settings menu.

Figure 66 Menu available for Super Admin

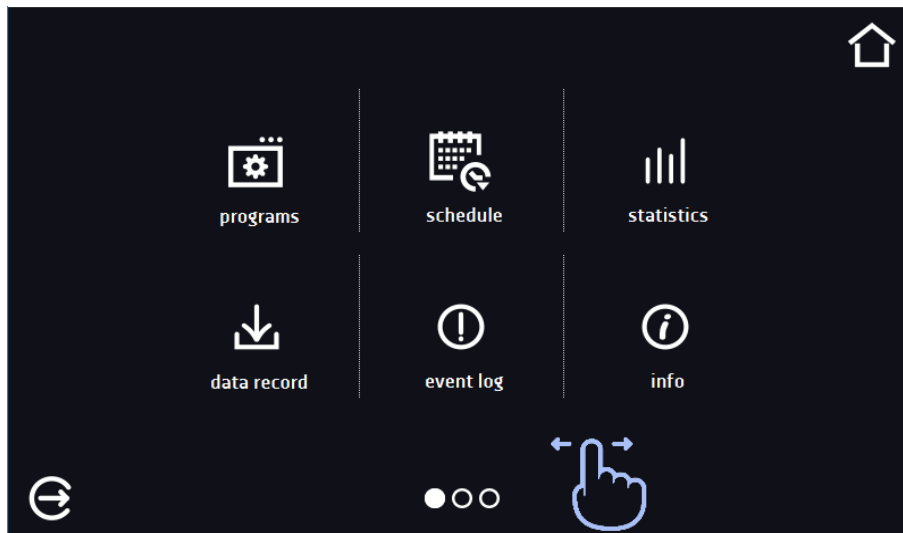

Information about the currently displayed window indicates .

Admin account



Has access to **programs menu**  and has rights and limitations in accordance with [table 1](#).

Figure 67 Menu available for Admin



User account:

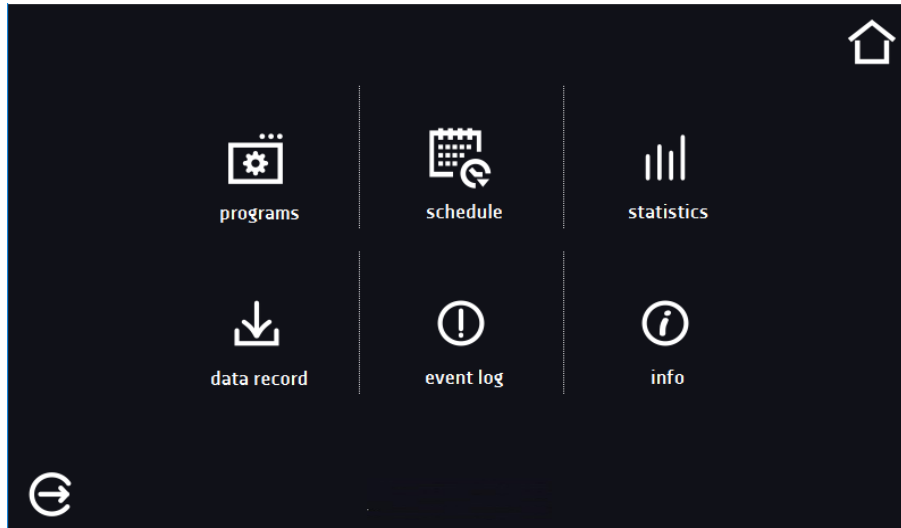

- has access to **programs menu** , where User can start **programs** previously assigned to him, check their statistics (**statistics**, **data register**), check events history of the equipment (**event log**) and the information about the system (**info**),
- can't create his own programs and schedules but start those which has been assigned to him by Super Admin,
- can't stop or edit a program or schedule which wasn't started by him,
- doesn't have access to create or edit schedules,
- the program started by the User can be stopped by a user with Super Admin privileges.

Other rights and limitations of the User type account are shown in [table 1](#).

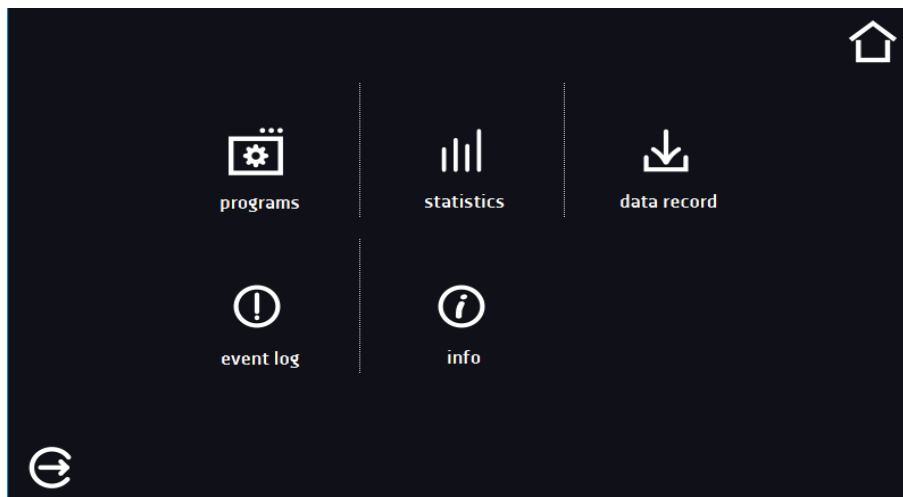







Figure 68 Menu available for User



6.16. **User settings panel**

Go to the main menu  and press the icon . In this panel ([Figure 69](#)) you can:

Instruction manual ST, CHL, ILW SMART PRO

	Change the name of the equipment – by default, the device serial number is entered.
 English	Change the language in the equipment's menu.
	Set the time after which the screen will be dimmed.
 <input type="checkbox"/>	Turn on/off the sound . Critical alarms will continue emitting a sound.
	Set the time after which the user will be automatically logged out. Available settings: off, 1 min, 3 min, 5 min, 10 min. Factory setting: enabled.
	Set the time after which the user will return to the home screen. Available settings: off, 1 min, 3 min, 5 min, 10 min.
	Set the automatic screen lock. Available settings: off, 5 min, 15 min, 30 min, 60 min. Factory setting: disabled.
 <input checked="" type="checkbox"/>	Enable / disable data register on a USB flash drive (connected to the USB port on the front of the unit).



Only one feature can be enabled at the same time: automatic logout or automatic screen lock.

Figure 69 User settings panel

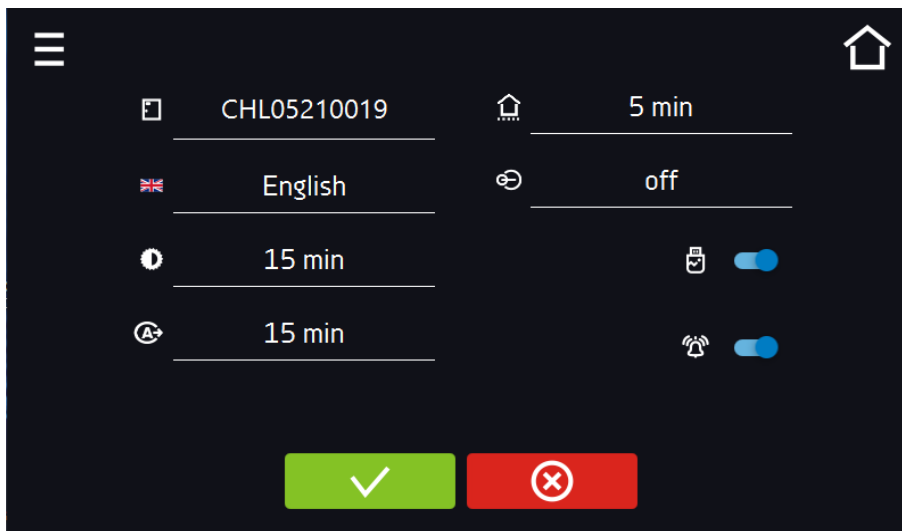

Confirms changes



Cancel the entered changes



6.16.1. Unlocking the touch screen

When the automatic touch screen lock is enabled (Section 6.16), slide the blue circle into the white circle to unlock the screen.

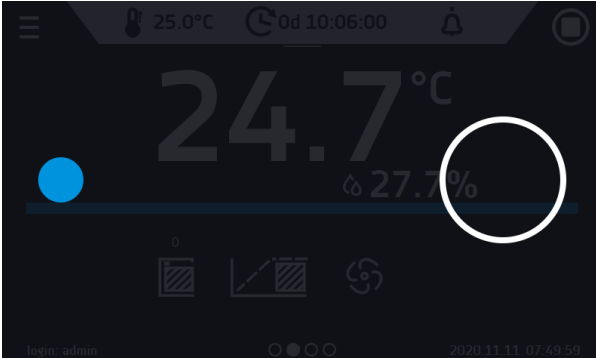
Figure 70 Unlocking the touch screen



6.17. Time

Go to the main menu  and press the icon . In this panel you can change the date and system time and time zone.

	The time and time zone must be set correctly during the first start-up.
---	---

Change of the date / system time

	If the date / system time is changed to the later date / time comparing with the data and events which are stored in the memory, they will remain in the register. If the date / system time is changed to the earlier date than the date / time which is stored in the memory, they will be transferred to the archive
---	---

After changing the date/system time the device will be restarted.

To change the date / system time it is necessary to press  in the window (Figure 71). The window will appear and you will be able to make changes (Figure 72).

Figure 71 Time change

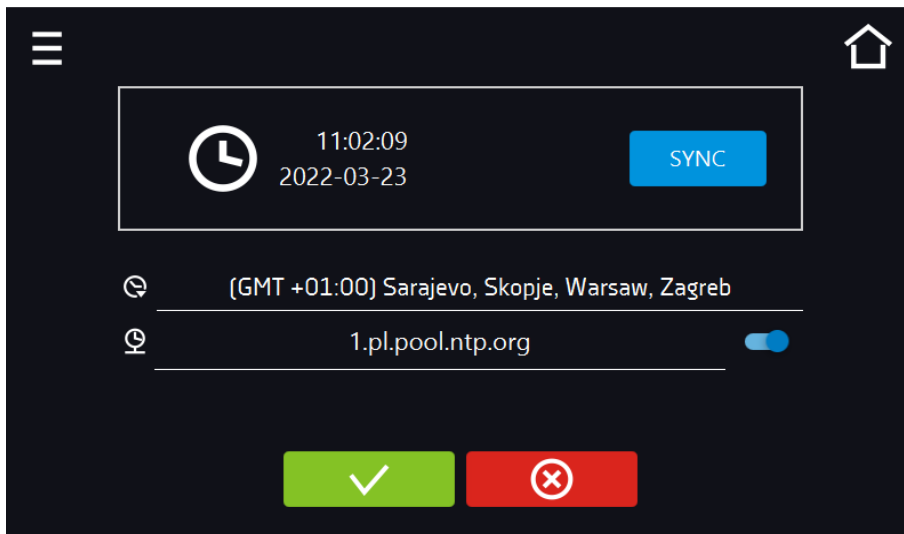

If the unit is permanently connected to the internet, the time will be synchronized with the time server. Time synchronization is performed:

- manually using the button **SYNC**
- while enabling the automatic synchronization option and then every 12 hours (🕒)
- after starting the unit, then every 12 hours



If the time in the equipment was set incorrectly or it became out of sync with the period of use (which is natural), then if:

- automatic synchronization is turned on and the device is not connected to the internet but will be able to access the internet
- automatic synchronization is turned off and will be turned on, in addition, the unit is connected to the internet

the time will be synchronized with the NTP time server.

Figure 72 Date / time change



Confirms changes and restarts the device



Cancels the entered changes

Change of time zone

The change of time zone will not affect the date / time in data and events previously saved.

To change time zone, you have to press the button  in the window (Figure 70). Select the time zone from the drop-down list. After changing only the time zone, the device is not restarted.



Confirms changes



Cancels the entered changes



The same time zones on the device and computer are required for correct operation of the programs.

6.18. Alarms

6.18.1. Alarms when set parameters are exceeded

Press the main menu icon , and then press . Here you can set parameters related to alarms

- **low alarm** – an alarm will be generated if the temperature drops below the set value by the value specified in this field,
- **high alarm** – an alarm will be generated if the temperature increases above the set value by the value specified in this field.



In the "lower alarm" field you can enter a value from the range of -0.5°C to -5°C, and in the "upper alarm" field from the range of 0.5°C to 5°C.

Figure 73. Parameter exceedance alarms

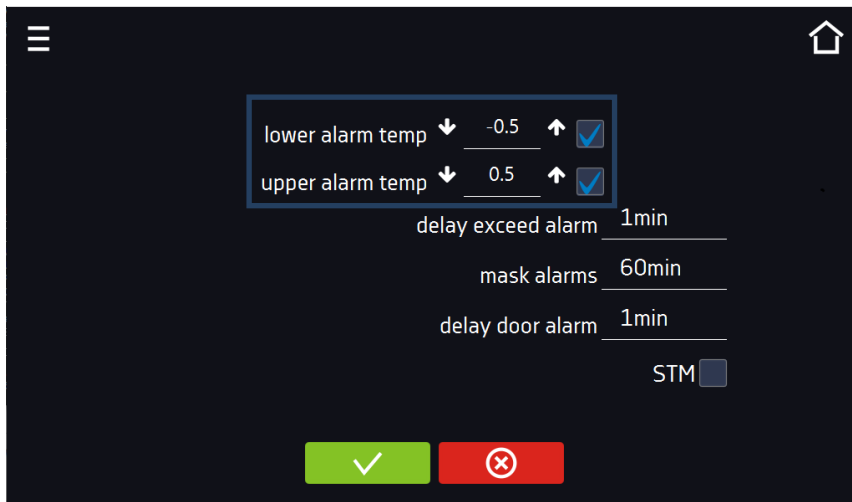

Confirm the changes.



Cancels the entered changes.

The upper and lower alarms can only be generated when the set temperature is reached.

- **temperature alarm delay:**
the alarm will be activated with a delay (1 min, 2 min, 5 min, 10 min, 15 min) after exceeding the permitted temperature.

6.18.1.1. Masking of parameter exceedance alarms

Masking of alarms when the set parameters are exceeded can be used when new samples are added to the chamber or samples are added to those already incubated. During these activities, the set parameters, i.e. temperature, may be exceeded and alarms may be activated - parameter exceedance alarms are set assuming that stable conditions prevail in the chamber (temperature) and the door is closed. After opening the door and placing the samples in the chamber, time is needed for the parameters to stabilize - the alarm masking function allows you to delay alarms when the parameters are exceeded.

The parameter exceedance alarm will be triggered with a delay (15 min, 30 min, 45 min, 60 min, 120 min, 150 min, 180 min) after inserting new samples. The time is counted from the last time the door was opened. Setting 0 s means masking is disabled.



If the door is opened during the parameter exceedance alarm, the ongoing alarm will not be "masked". Only the next alarm can be masked.

Figure.74. Alarm masking

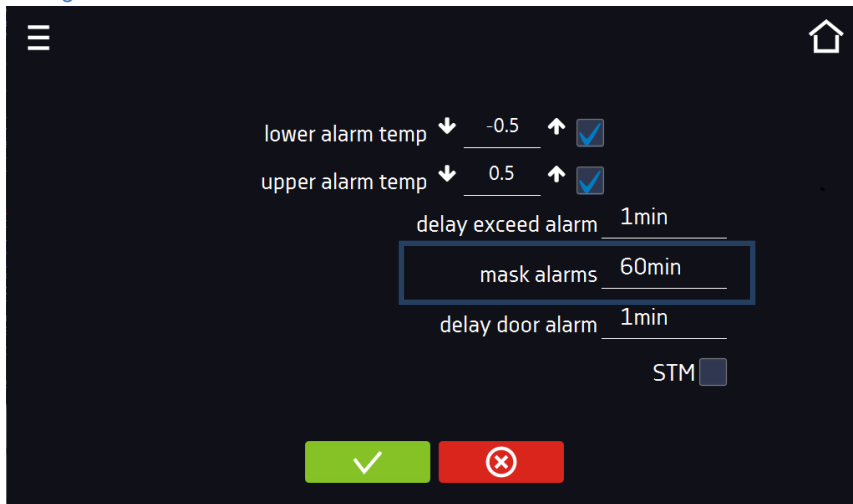

Confirm the changes.



Cancels the entered changes.

Figure.75. Alarm masking enabled

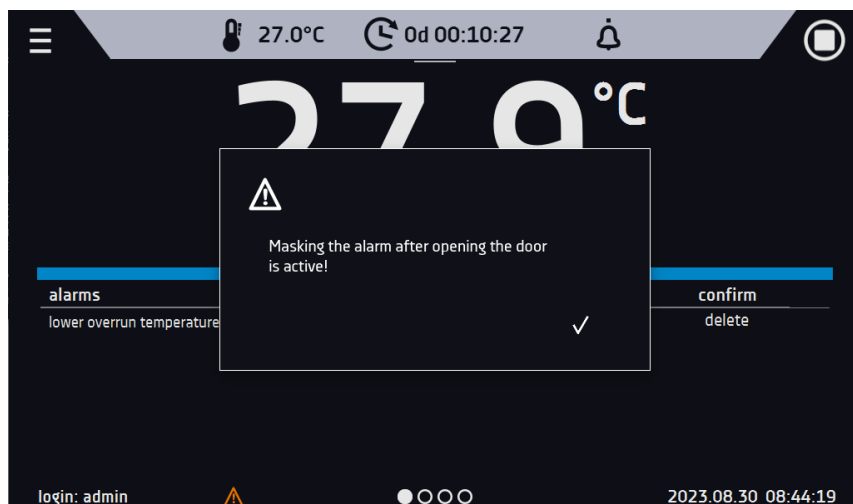

6.18.2. Open door alarm

All devices are equipped with an open door sensor. If the door is left open longer than the time set by the user, an acoustic signal, a red flashing alarm bar and a "door open" alarm with the status "active" will appear.

- **door open alarm delay:**
The door alarm will sound when the door is open for the user-selected time (30 sec, 1 min, 2 min, 5 min, 10 min).

Figure.76. Open door alarm delay

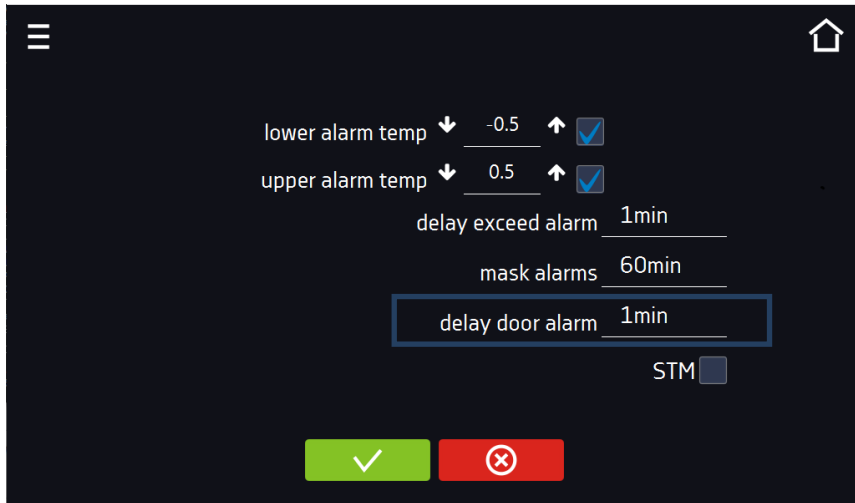

Confirm the changes.



Cancels the entered changes.

6.18.3. STM function

The STM (Smart Temperature Monitor) function informs the user if there is a problem in reaching or maintaining the set temperature. The user can enable/disable the function (Fig.77).

If the STM function is enabled, the STM symbol will appear on the screen next to the temperature of the main sensor.

Figure. 77. Enable/disable STM function

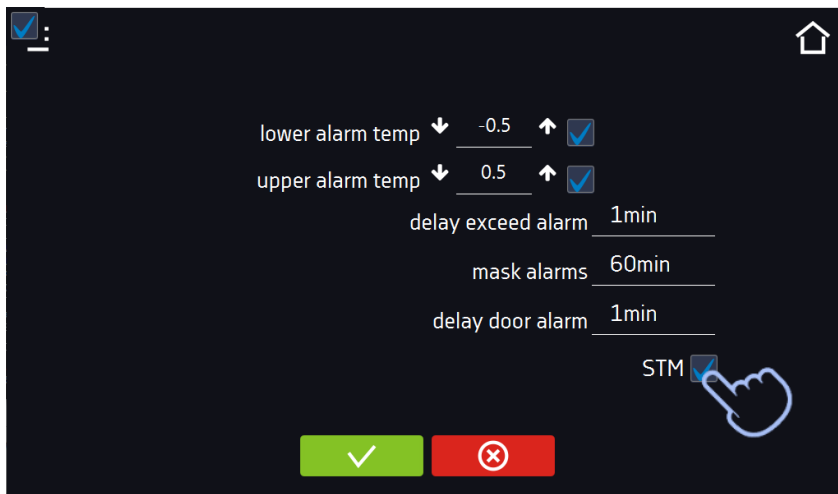



Confirm the changes.



Cancel the entered changes.

The function status is indicated by color:

- no inscription – option disabled,
- white color – option enabled, program is stopped (Fig. 71),
- blue color – option enabled (temperature monitoring), program running (Fig. 72),
- red color – option enabled, warning about problems with achieving/maintaining temperature (Fig. 73).

Figure. 78.



Figure. 79.



Figure. 80.



Possible causes of operation:

1. damaged heater,
2. the cartridge inserted into the chamber absorbs / releases too much energy.

If the color was red before opening the door, then the color changes to blue after opening the door.

If the function is activated (detection of problems with achieving/maintaining temperature):

- the warning 4.00.0.1.009... appears in the event log.
- the color of the STM inscription changes to red and remains red throughout the disruption, segment change, and program shutdown.
- when the state changes from red to blue, an entry about the end of function 4.00.0.1.010 appears in the event log.

6.18.4. Mute option

The icon  in the main screen in the upper menu allows temporary switching off of the alarms sound (open door alarm, exceeding temperature range), e.g. to avoid door alarm during planned loading of the samples into the chamber.





To set the mute time, press the icon  and choose: 5, 10 or 15 minutes, however, the sounds of critical alarms (e.g. damage to the temperature sensor, over- and under-temperature protection) will be still emitted.

Figure. 81.

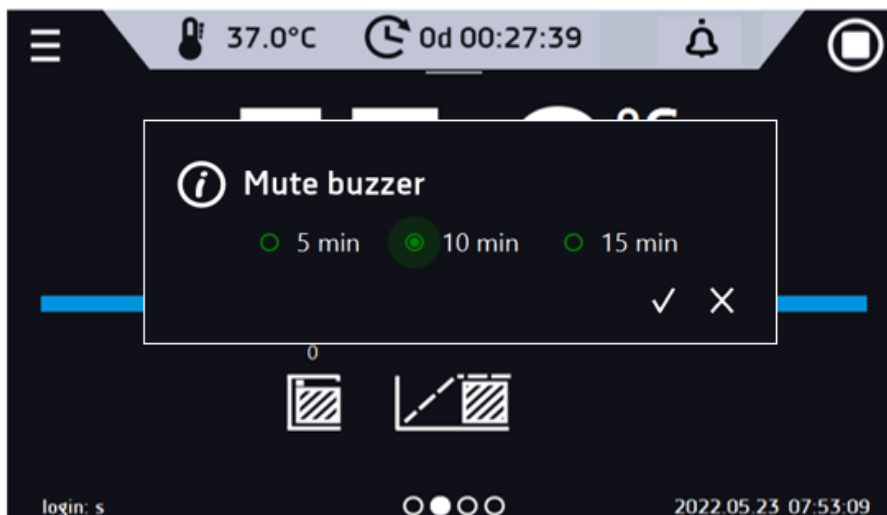

6.19. Network

Go to the main menu  and press the icon . In this panel you can change the settings for LAN or WiFi. Switch between LAN / WiFi network by pressing  or .

LAN settings:

- **IP** – the device's IP address
- **Mask** – an Ethernet network mask to which the device is connected
- **Gate** – Server's IP address or router's that manages the Ethernet network
- **DNS** – IP address of the domain name system
- **MAC** – the address of the network card, read-only
- **DHCP** – you can select if the server that allocates IP addresses is running on the local network. You can then skip setting IP, Masks, Gates

Icon **A** indicates the connection status:



Device connected to the network



Device disconnected from the network

Figure 82 LAN settings

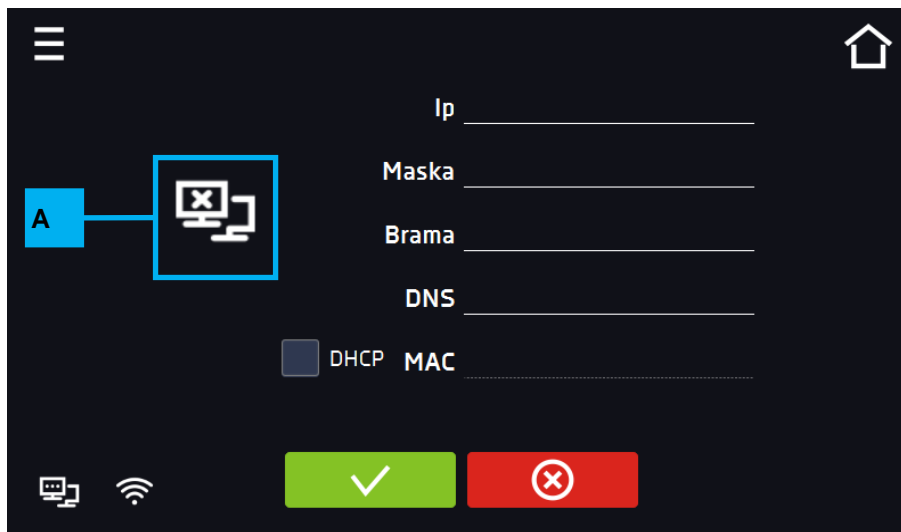

Confirms changes



Cancels the entered changes

WiFi settings:



-  – press to refresh network list,
- **SSID** – press to select network from the drop-down list,
- **PSK** – network password,
- **IP, Mask, Gate, DNS** – after a successful connection to the network these fields are automatically completed,

- **MAC** – physical address of the network card, read-only.

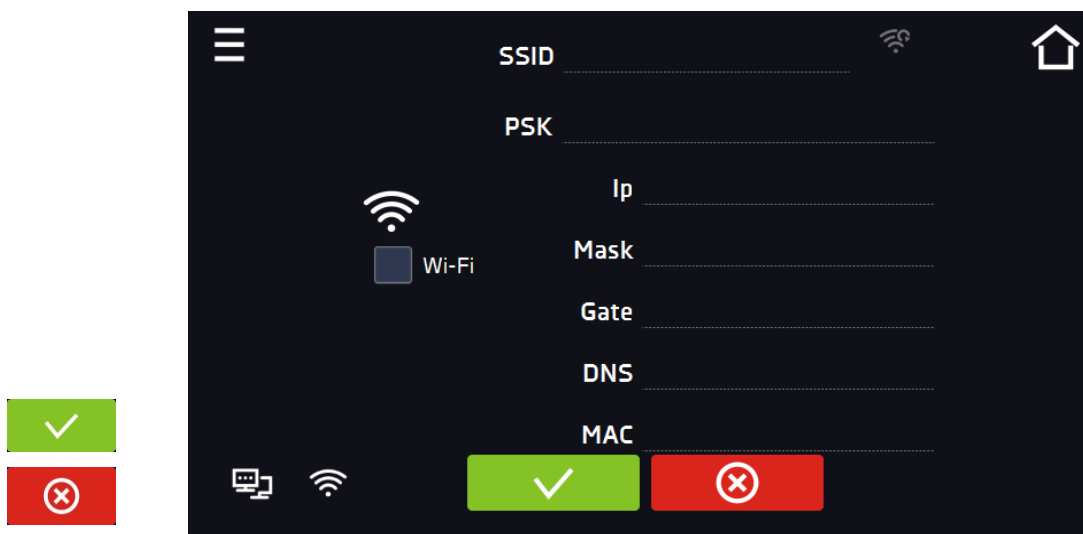
Figure 83 WiFi settings



6.20. E-mail reports

Go to the main menu  and press the icon . In this window you can set the parameters needed to activate e-mail notifications.

In the panel there are three windows:



Selection of event types for which notifications should be sent (Figure 78).

- **Activate** – turning on/off e-mail notifications,
- **Doors alerts** – alarms triggered by an open door,
- **Critical alerts** – critical alarms (e.g. sensor damage),
- **Temperature alerts** – alarms caused by too high or too low temperature,
- **Programs events** – program-related events (e.g. adding, editing, deleting a program),
- **Users events** – events related to editing user settings (e.g. adding, editing, deleting users).

Figure 84 E-mail: events

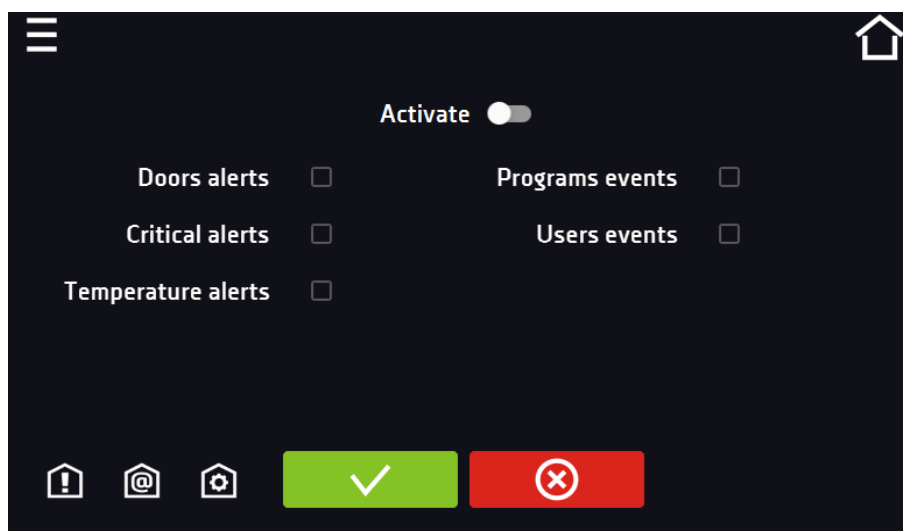



Confirms changes



Cancels the entered changes



If the "activate" option at the top of the panel is not enabled, emails will not be sent!



Sender and recipients [\(Figure 85\)](#)

- **Sender** – sender's e-mail address
- **Recipients** – recipients e-mail addresses, maximum 3

Figure 85 E-mail: Sender – Recipients

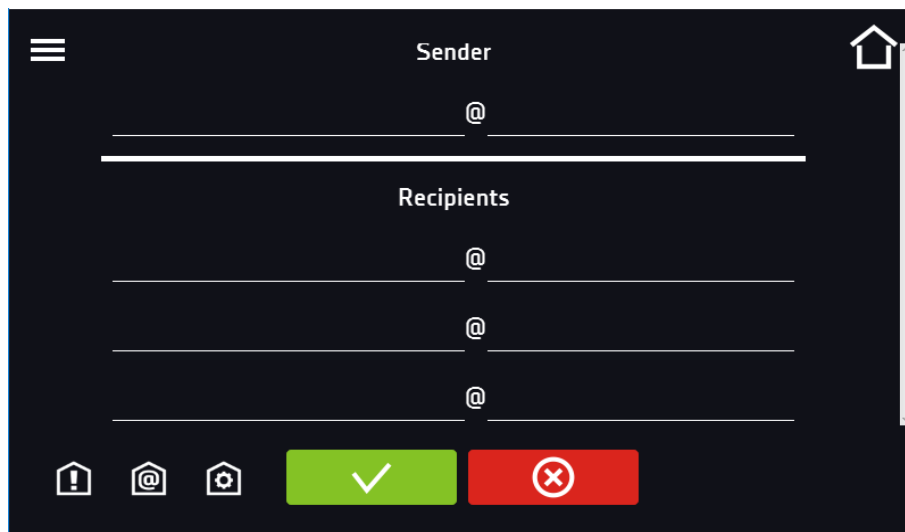

Confirms changes



Cancels the entered changes



Configuration of the sender's e-mail account [\(Figure 86\)](#)



In this window, enter your e-mail account details:

- SMTP server user ID
- SMTP server password
- SMTP server host
- SMTP server port

You can also choose the **TLS** or **SSL** encryption method (get more information from your email account provider).

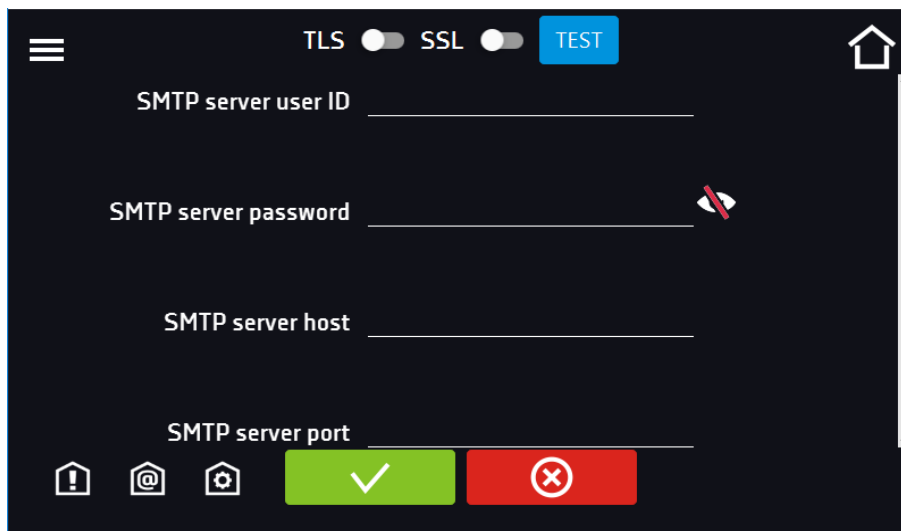
Figure 86 E-mail: email account configuration



-  Connection test
-  Confirms changes
-  Cancels introduced changes

 Before testing the connection, make sure that the device is connected to the network and has a properly configured network connection, see [Section 6.19](#).

6.21. Automatic defrosting function (optionally for ST 1-6, ST 500-1450, CHL 1-6, CHL 500-1450, ILW, standard for ST 500 M-1450 M i CHL 500 M-1450 M)*¹

*¹ – All models which are equipped with automatic defrosting (ST/CHL PLUS) don't have a standard defrosting function. The automatic defrosting function it's a recommended option available for ST thermostatic cabinets, ST1-6 and ST 500-1450 models, CHL laboratory refrigerators CHL 1-6 and CHL 500-1450 models and ILW laboratory incubators. ST 500 M – 1450 M thermostatic cabinets and laboratory refrigerators CHL 500 M – 1450 M are equipped with automatic defrosting function as standard (these equipment have a cooling system in the form of a monoblock which is no Frost). Remember that as in the case of the automatic defrosting function in ST 1-6, ST 500-1450 and CHL 1-6, CHL 500-1450 models, defrosting parameters in equipment with monoblock should be defined in the program as described below.

 Default settings - 2 minutes defrosting every 2 hours, causes a temporary increase in temperature in the chamber. Defrosting parameters can be changed by the User depending on the application - test type (wet / dry), door opening frequency, etc.

Go to the main menu  and press the icon . In this panel ([Figure 87](#)) you can control the defrosting of the interior of the device. Option available for ST, CHL, ILW. The automatic defrost function is active when the "enable" box is checked ([Figure 87](#), ) , otherwise the function will not work (also default settings).

You can set:

- **Period [h]** – indicates the frequency of defrosting process for the set temperature $\leq 5^{\circ}\text{C}$.
- **Time [s]** – the time of defrosting,
- **Delay [min]** - time after defrosting that does not generate temperature alarms, given in minutes.

Pressing the button  – restores the default defrost settings (period [h]: 2, time [s]: 120, delay [m]: 0).

NOTE: the option  must be selected.

Figure 87 Defrosting program





Confirms changes

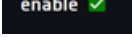
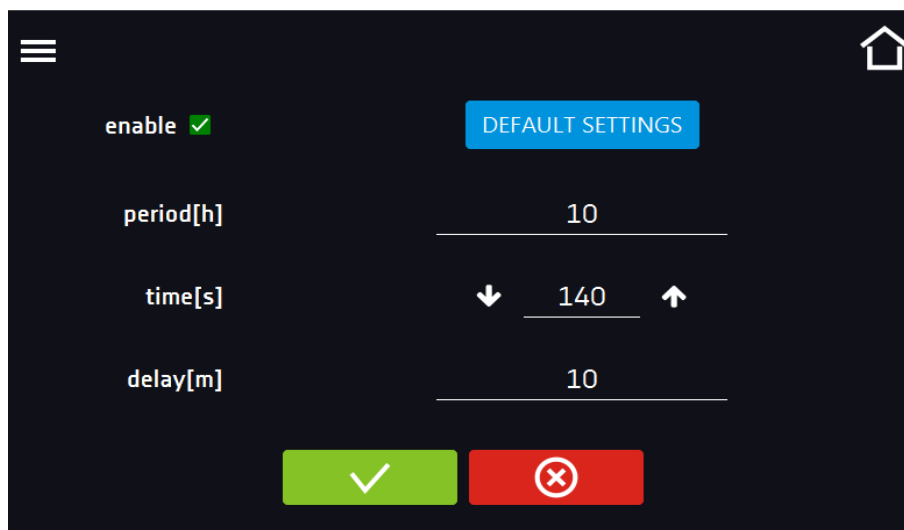

Cancels the entered changes

6.22. Temperature – additional temperature sensor Pt 100 (option)

Go to the main menu  and press the icon . In this panel (Figure 88). You can set parameters related to the temperature measurement in the equipment using an additional temperature sensor.

Additional sensor

The following parameters can be set relative to the additional temperature sensor:

- **mode** – sensor operation mode:
 - **disable** – the sensor is switched on,
 - **measure** – displaying in the main window and recording temperature from the additional temperature sensor,
 - **compensation** - displaying in the main window and recording temperature from the additional temperature sensor + compensation,
- **rate [C°/min]** – determines how fast the equipment is to respond to differences in temperature indications between the additional temperature sensor and the main sensor (higher value = faster response of the equipment, can affect the stability of temperature maintenance),
- **limit** – parameter which defines the acceptable difference in temperature compensation during operation; the limit range is from 2°C to 8°C .

Compensation

The compensation value is a correction for the regulation of the main sensor in order to obtain the set temperature at the place of measurement of the additional sensor. To control the equipment according to the additional temperature sensor's indications, select the "compensation" operating mode. An additional temperature sensor can be used to control the temperature in the chamber according to e.g. sample temperature.

Figure 88 Temperature measurement settings with an additional sensor

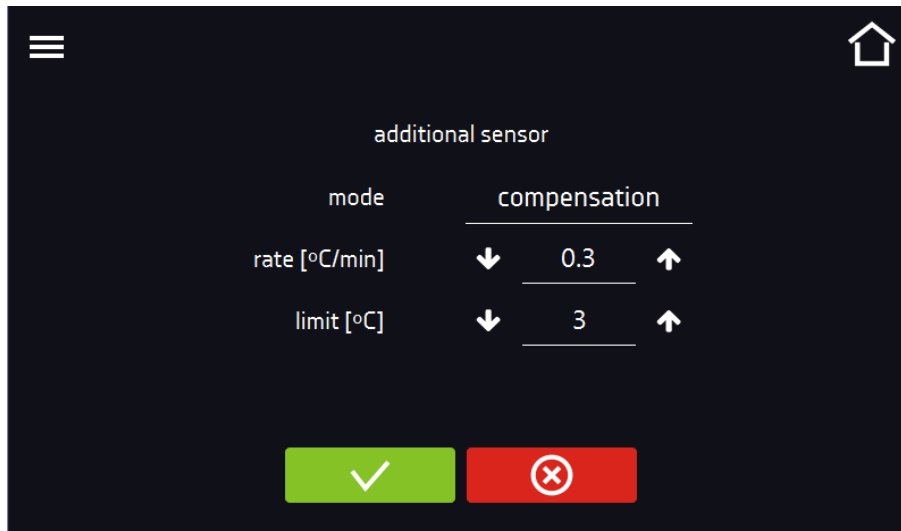



Confirms changes



Cancel the entered changes

6.23. +/- Corrections

Go to the main menu  and press the icon . In this window (*Figure 89*) you can correct temperature value indicated on the display by adding the correction value. The set correction value applies to the whole temperature range of the device. For example, if the average temperature displayed by the device indicates 20,0°C and the average temperature measured by independent, external sensor indicates 20,5°C, the correction should be set on +0,5°C. The average temperature should be calculated from chosen period of time e.g. 30 min. The correction available range is between -5°C to +5°C.



The device has been calibrated by the manufacturer in accordance with applicable norms. The temperature shown on the display corresponds with a great accuracy to the temperature near chamber's sensor. For the correct operation of the device it is not necessary to use User's calibration. The User is performing temperature correction **on his own responsibility** and must be aware of consequences of changing manufacturer's settings. If the equipment was calibrated, calibration certificate **loses its validity**.

Figure 89 User's correction

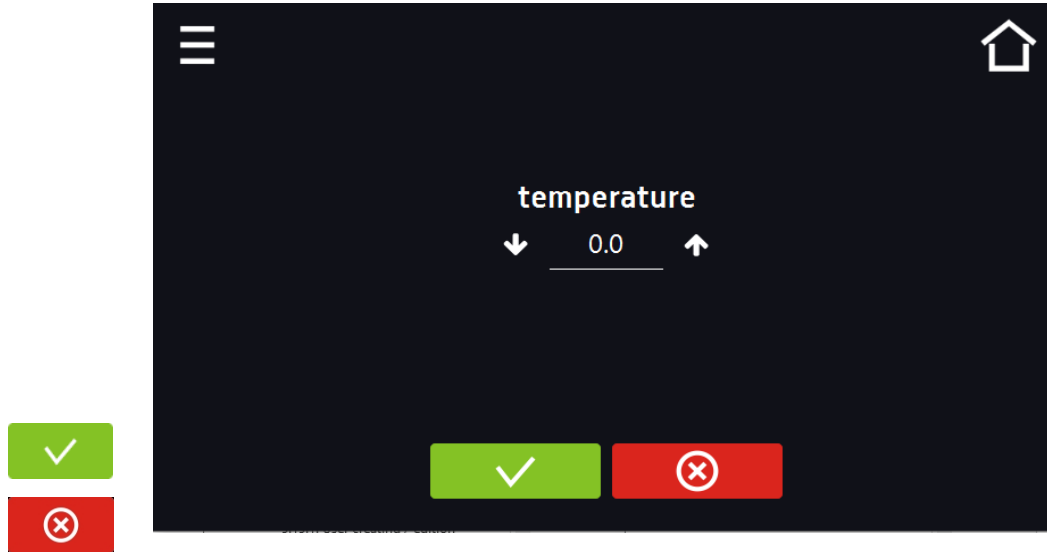

7. INTERFACE

7.1. MODBUS TCP

The device allows status monitoring using the MODBUS TCP communication interface.

Connection parameters:

- IP address: same as device's (set in the panel [Section 6.19](#))
- port: 502

register INPUT REGISTERS function READ_INPUT_REGISTERS (0x04)				
Modbus adres	Offset	Type	Multiplier	Description
30000	0	int	10	temperature from the main sensor
30001	1	int	10	temperature from the additional sensor (option)
30003	3	bool	-	open door
30004	4	bit	-	b0 – door alarm b1 – upper temperature alarm b2 – lower temperature alarm b3 – over Protection b4 - under Protection b5 – main sensor error b6 – additional sensor error b7 – protection sensor error b8 – temperature sensors error b10 – hardware error b11 – MRW error
30050	50	Int	-	Settings for each light point can be read at a separate address. The amount depends on the device configuration. FIT version: percentage value of the light (0-100)
...	...	int	-	
30068	68	Int	-	

8. TEMPERATURE PROTECTION

The device is factory fitted with sample protection - temperature protection. If any of the elements responsible for maintaining the set temperature is damaged or the user sets the temperature unconsciously, the set protection will work.

8.1. Temperature protection class

Standard equipment in the ST and ILW devices is protection class 3.3 according to DIN 12880, while in CHL refrigerators it's 3.2 according to DIN 12880. The user programs the temperature value of the lower / upper protection. When the set temperature is exceeded, the cooling or heating system power will be turned off. When the temperature returns to the allowed range, the device will resume operation. The figure below shows how this works.

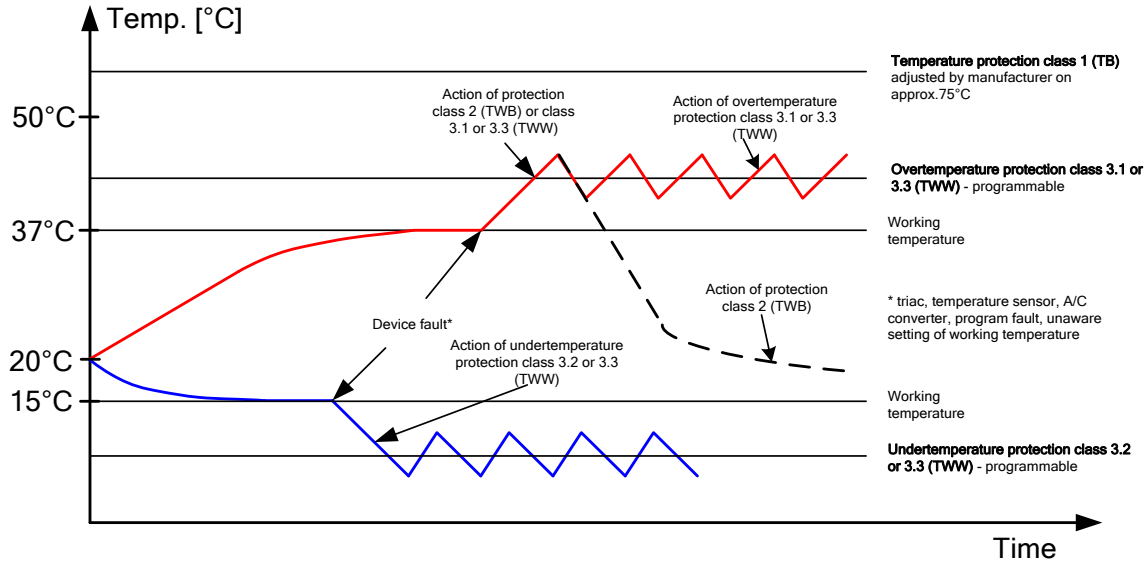

9. CONNECTING THE DEVICE TO A COMPUTER

Each device in the SMART PRO version can be connected to an Ethernet network or directly to a computer with a LAN cable (standard equipment). Using the Lab Desk program (standard equipment), you can program and monitor the operation of multiple devices with the SMART PRO controller. The features of the software have been described in a separate instruction manual.

10. OPERATION OF THE COOLING SYSTEM

In ST thermostatic cabinets, in the models: ST 1, ST 2, ST 3, ST 4, ST 5, ST 6, ST 500, ST 700, ST 1200, ST 1450, in CHL laboratory refrigerators, in the models: CHL 1, CHL 2, CHL 3, CHL 4, CHL 5, CHL 6, CHL 500, CHL 700, CHL 1200, CHL 1450 and in ILW laboratory incubators if the unit is operating in low temperatures the evaporator may get covered with ice. This can affect the lower cooling efficiency of the device.

In ST thermostatic cabinets, in the models: ST 500 M, ST 700 M, ST 1200 M and ST 1450 M, in CHL laboratory refrigerators, in the models: CHL 500 M, CHL 700 M, CHL 1200 M and CHL 1450 M the cooling system is based on a monoblock in which the evaporator is defrosted with warm gases, which prevents it from being frosted. Depending on the stored samples, defrosting parameters should be defined empirically ([see Section 6.21](#)).

To ensure proper operation of the device you should obey these principles:

- | | |
|----|--|
| 1. | At temperatures above +8°C the air automatically defrosts the ice cover, defrosting is self-operating. |
|----|--|

2.	At temperatures below +8°C the evaporator may be covered in ice and the device should be defrosted manually. If the unit works in a temperature below +8°C and the User does not defrost it periodically, the compressor may overheat and break down.
3.	The device is equipped with a protection mechanism against damaging the cooling system. The mechanism makes it impossible to turn on cooling when the temperature exceeds 45°C. As a result if the device has been programmed to go down to a lower temperature (e.g. from 60°C to 20°C) it may take longer for the program to operate until it reaches 45°C. The temperature inside the device is lowered naturally by emitting the heat to the surrounding environment. To speed up this process, it is recommended to open the chamber door for the time needed to cool the interior of the chamber.
4.	Always make sure that the door has been closed properly!

11. CLEANING AND MAINTENANCE OF THE DEVICE

	Disconnect the device from the power supply before carrying out any activities related to the cleaning! In the case of the battery back-up of the controller, also turn it off.
---	--

On the internal walls of the device (in particular the new one) made of stainless steel, discoloration (spots) may appear - which are not caused by factory defects, but only by the steel production process. They can be cleaned using extraction gasoline.

INOX products are manufactured with stainless steel. When used in standard laboratory conditions they do not rust. However it is possible that stains (which may look like rust) form on the steel surface (e.g. due to the kind of samples that are incubated in the chamber). In such case we recommend using cleaning solution (to clean the stains) which is dedicated to this particular application, e.g. Pelox.

	When cleaning stainless steel product with dedicated cleaning solution, one should pay attention to the suggestions and recommendations given in the instruction manual or in the safety data sheet of the cleaning solution.
---	--

11.1. Exterior cleaning

1.	The housing of the device should be cleaned at least once a week, depending on the working conditions.
2.	The housing and door should be cleaned with caution using a soft cloth dampened with water.
3.	Only mild cleaning products should be used to clean the device.
4.	Electrical parts should not get in contact with water or detergent.
5.	Clean the touch screen using a soft cloth or a foam for cleaning touch screens.
6.	USB port can be cleaned with a vacuum cleaner to prevent accumulation of dirt inside the port.

11.2. Interior cleaning

The interior of incubators, thermostatic cabinets and laboratory refrigerators in the COMFORT and PREMIUM versions is made of 0H18 stainless steel in accordance with with DIN 1.4301 or 0H17 acc. with DIN 1.4016. Stainless steel also corrodes. To slow down the corrosion process as much as possible, this type of steel requires regular maintenance and cleaning. Aggressive cleaning agents and preparations based on chlorine and bleach should be avoided, stainless steel should not be allowed to come into contact with non-alloy steel, unless we are dealing with ground steel, and avoid materials that may scratch the surface.

Instruction manual ST, CHL, ILW SMART PRO

1.	Before cleaning the interior of the device, empty the chamber.
2.	Open the door of the device, if necessary wait till the chamber has cooled down, take out the shelves and start cleaning of the device
3.	To clean the device, use a lint-free, lint-free, soft cloth and water or water with a mild detergent.
4.	In the case of ground steel, movements should be made in the direction of grinding on the surface.
5.	<p>If rust occurs:</p> <ul style="list-style-type: none">• slight discoloration - use household cleaners for stainless steel containing calcium carbonate or citric acid,• medium discoloration - clean with a 10% phosphoric acid solution; after cleaning, neutralize the acid with diluted ammonia or a mild alkaline detergent,• severe rust – use products for pickling and passivation of steel – for example Pelox FR-D <p>After each cleaning, wipe the surface thoroughly with clean water.</p>
6.	Having finished cleaning, you should allow the device to dry fully and instal all parts removed before cleaning.
7.	During cleaning you should make sure not to damage the temperature sensors which are located inside the chamber.
8.	At least once every 6 months , use a vacuum cleaner, a dry cloth or a soft brush to clean the condenser located on the back of the ST 1-6 and CHL 1-6 devices. In the ILW laboratory incubator, the condenser is placed in the lower part. To access it, pull the ventilation cover (a) towards you, and then pull it up (b). After cleaning the condenser (1), reinstall the cover.

for: ST 1, ST 2, ST 3, ST 4, ST 5, ST 6
CHL 1, CHL 2, CHL 3, CHL 4, CHL 5, CHL 6

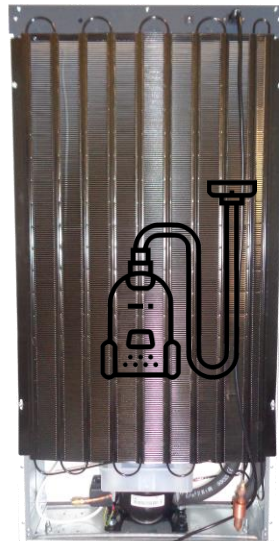

rear view

**for: ST 500 M, ST 700 M, ST 1200 M, ST 1450 M
CHL 500 M, CHL 700 M, CHL 1200 M, CHL 1450 M**

Before cleaning the condenser with a monoblock system, disconnect the device from the mains. To clean the condenser, it is not necessary to remove the cover. The condenser should be cleaned with a vacuum cleaner or a soft brush. After cleaning, the condenser should be free of dust and solid impurities. Cleaning should be performed every 6 months or when you notice that the condenser is dirty.

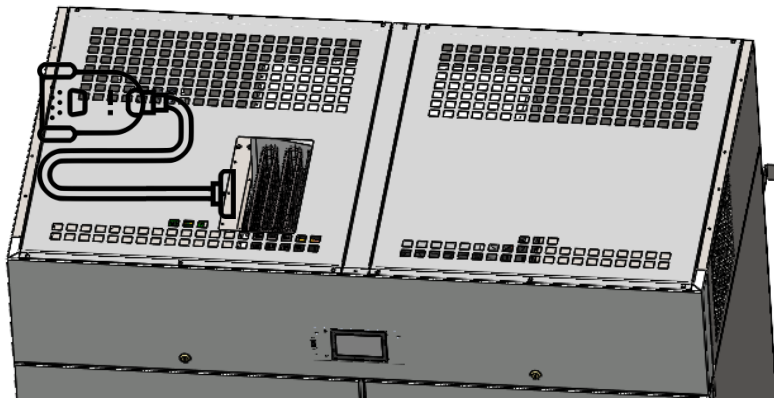
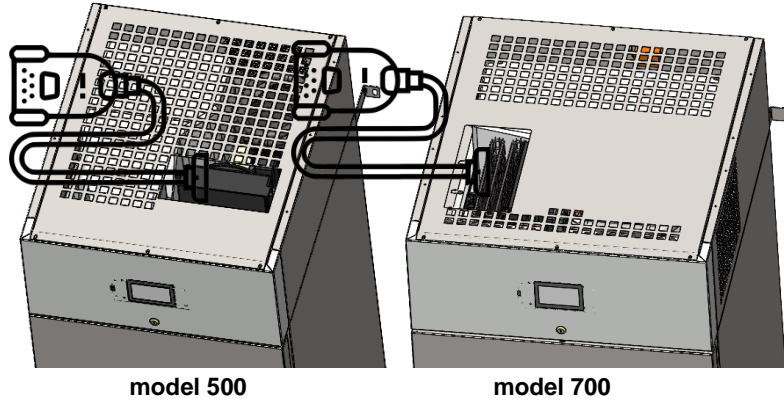

The picture above shows the location of the condenser for the 1200 and 1450 series

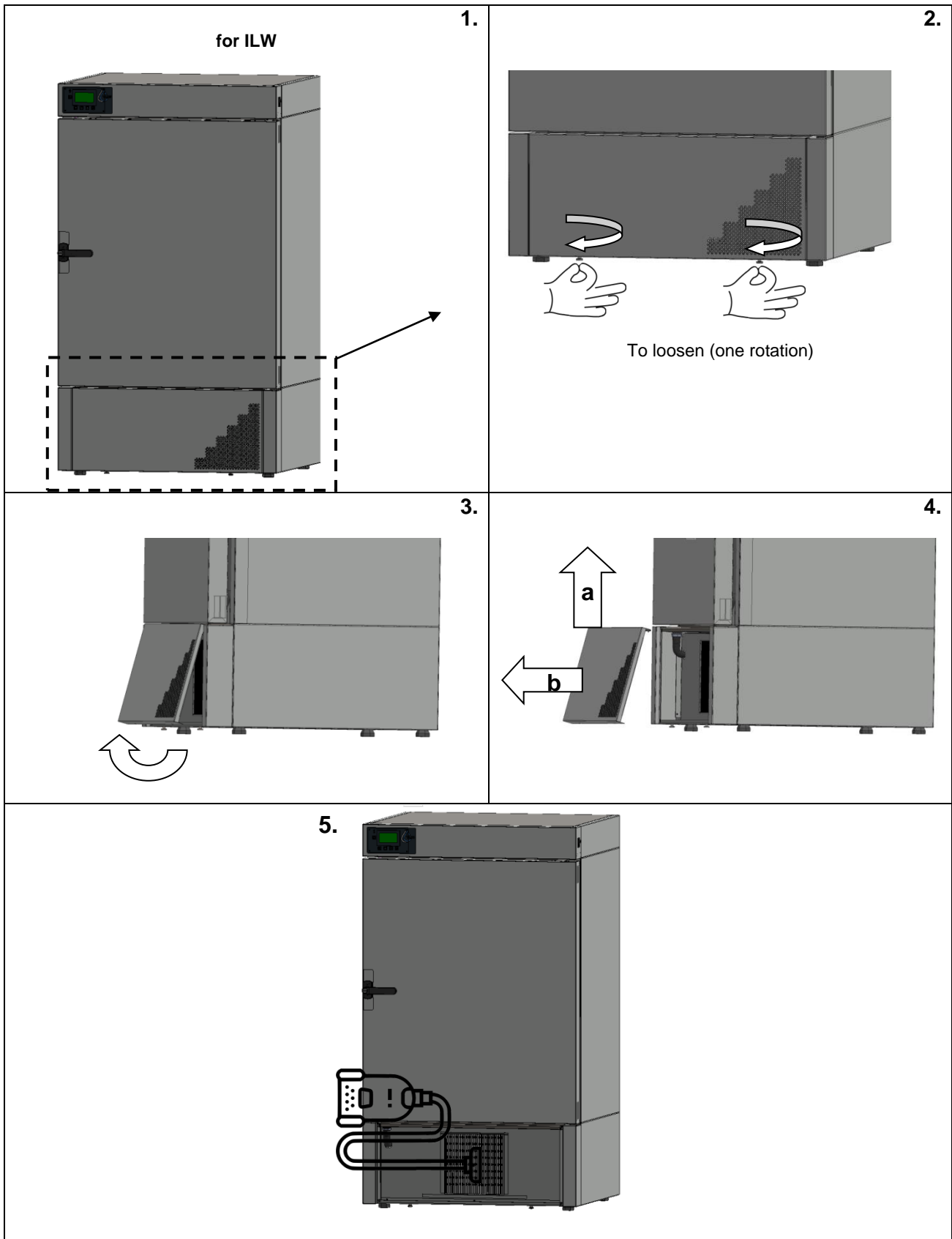

Failure to clean regularly may result in damage to the compressor and loss of the rights for repair under warranty.

11.3. Cleaning the touch screen

The touch screen is exposed to dirt, so it must be cleaned regularly. To clean the touch screen, use a clean and dry microfiber cloth. It is a very delicate material and collects dirt well.



Before using the cloth, **make sure that on the surface there are no crumbs or particles**. During cleaning, they can act like sandpaper and **scratch the surface of the screen**.

If the stains cannot be removed by dry cleaning, the cloth can be lightly dampened with water.



Do not use paper towels to clean the screen as it may cause microdamages.

Before cleaning, lock the screen by pressing  on the top drop-down list (*Figure 90*).

Figure 90 Locking the screen

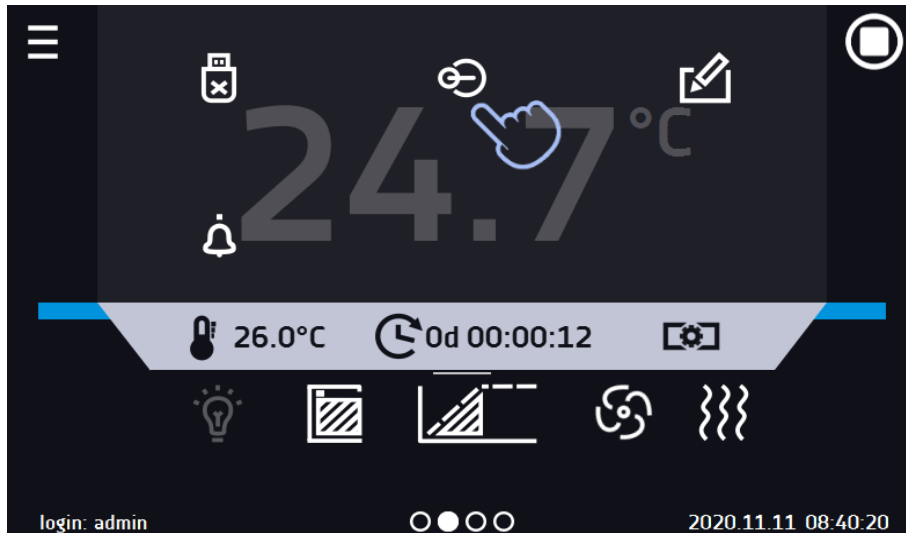

The screen is ready to be cleaned.

To unlock the touch screen, slide the blue circle into the white circle

Figure 91 Unlocking the screen

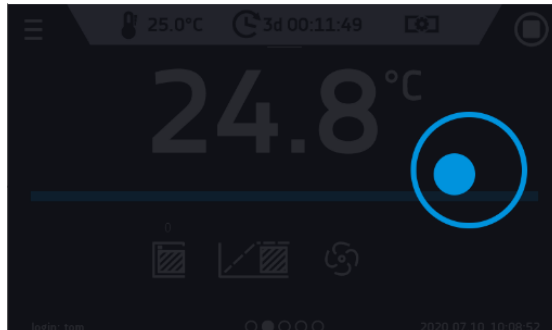
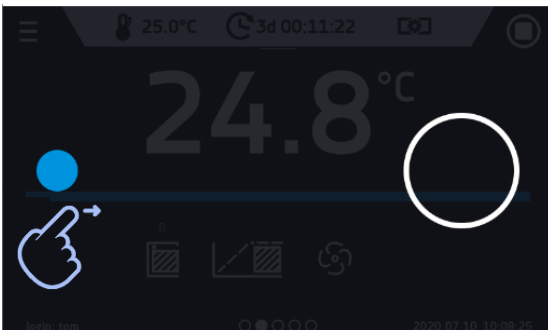

11.4. Consumables

Consumables during normal operation are:

- silicone door seal - in all units,
- chamber fan,
- interior lighting bulb - in units with the option of interior lighting.

12. ADVICE ON HOW TO SAFELY STORE THE DEVICE

1.	Remove all objects from the chamber.
2.	Disconnect the device from the mains. If the unit is equipped with battery back-up of the controller (optional), also turn it off.
3.	Clean and dry the chamber.
4.	Leave the door open to avoid unpleasant odors.
5.	Store in temperatures between 0°C and 50°C and relative humidity maximum 70%.

13. TROUBLESHOOTING

Before you contact Service Department:

1.	Make sure that the operation complies with the instruction manual of the device.
2.	Restart the device to make sure that the unit is not functioning properly. If it still does not work, disconnect the unit again from the mains and repeat the operation after one hour. Do the same with optional battery back-up of the controller.

Service

Visit the POL-EKO website at: www.pol-eko.com.pl in order to:

- get full contact details of technical service
- access to POL-EKO online catalogue, and information about accessories and related products
- receive additional product information and special offers

To receive information or technical assistance, contact the Service Department or visit the website: www.pol-eko.com.pl

13.1. Possible defects

Malfunction	What to check?	What to do?
The unit is not working	Check if the unit is plugged in correctly	Plug in the unit correctly
	Check if the circuit-breaker has tripped	Press the circuit breaker on the back of the device
	Check the voltage in the socket	Connect the device to a different socket, preferably from a different electrical circuit. Call a licensed electrician to check the electrical installation.
	Check if the power cable is broken	Change the cable
The unit is not cooling down	Check if the condenser is dirty	Clean the condenser
	Check if the unit is exposed to direct sunlight	Change the location of the unit
	Check if there is a heat emitter near the device	Change the location of the unit
	Check if the door is closed properly	Clean the gasket
The unit is not heating up	Check if the door of the unit is closed properly	Clean the gasket
	Check if the fan is turned on	Set the fan operation in the program
	Check if the ambient temperature is within the permissible values given in the technical data table?	Adjust the ambient temperature to the value given in this manual
The unit is working too loud	Check if the unit is not touching other objects or furniture etc.	Remove other objects
	Check if the door is properly leveled	Level the device
The door has dropped or is skewed	Check if the door is properly leveled	Level the device. If this does not help, contact the service.



For ILW, ST and CHL: gurgling sound of the refrigerant fluid flowing in the refrigerant circuit is normal.

14. WARRANTY CONDITIONS

POL-EKO warrants that this product will be free from defects in material and workmanship for a period of two (2) years from date of the invoice. If a defect is present, POL-EKO will, at its option and cost, repair, replace, or refund the purchase price of this product to the customer, provided it is returned during the warranty period. This warranty does not apply if the product has been damaged by accident, abuse, misuse, or misapplication, or from ordinary wear and tear. If the required maintenance and inspection services are not performed according to the manuals and any local regulations, such warranty turns invalid.

The device that is being returned must be secured by the customer in the event of any damage or loss. The warranty will be only limited to the situations listed above. IT IS EXPRESSLY AGREED THAT THIS WARRANTY WILL BE IN LIEU OF ALL WARRANTIES OF FITNESS AND IN LIEU OF THE WARRANTY OF MERCHANTABILITY.

All complaints should be reported using the form available on the website <http://www.pol-eko.com.pl/en/service>

Compliance with local laws and regulations

The user is responsible for obtaining any approvals or authorizations required to launch and use the product. POL-EKO shall not be liable for any negligence in the above matter except when the refusal to obtain authorization is caused by a product defect.

15. RATING PLATE

The rating plate is located on the left side wall in the upper left corner. Below there is an example of a rating plate:

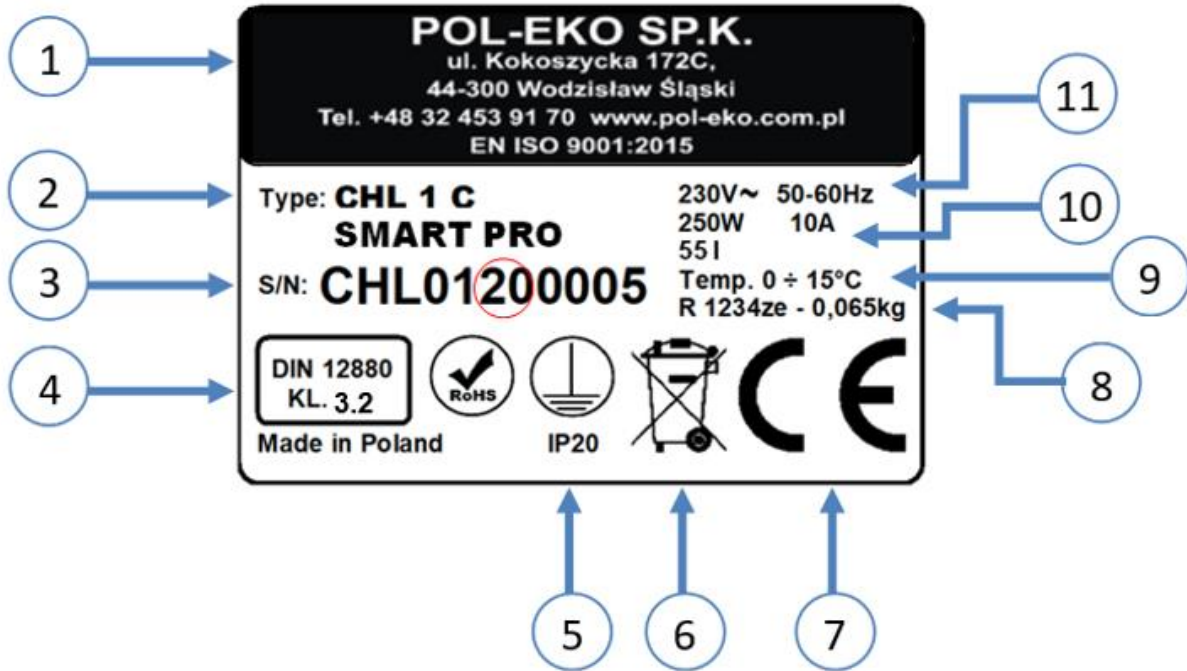

1. Manufacturer's data
2. Type of device
3. Serial number (the two marked digits indicate the year of manufacture of the device)
4. Temperature protection class according to DIN 12880
5. Degree of protection against electric shock (class I: protection against indirect contact) and IP enclosure protection rating
6. Disposal of used device according to WEEE2
7. CE marking as confirmation of compliance with the directives
8. Temperature range of the device
9. Information about cooling system (gas type and quantity)
10. Capacity of device
11. Acceptable range of voltage and frequency of mains supply

16. TECHNICAL DATA

Technical data are given with a tolerance of $\pm 5\%$, the working capacity of the chamber is always smaller. All the below technical data refers to standard units (without optional accessories).

16.1. ST, CHL devices

Parameter	ST1 CHL1	ST2 CHL2	ST3 CHL3	ST4 CHL4	ST5 CHL5	ST6 CHL6	ST500 CHL500	ST700 CHL700	ST1200 CHL1200	ST1450 CHL1450	
Air convection	forced										
Chamber capacity [l]	70	150	200	250	300	400	500	625	1365	1540	
Working capacity [l]	55	122	163	203	243	324	411	499	1239	1376	
Door	solid / glass door or double ¹ (option)										
Temperature range [°C]	CHL	[°C]	0...+15					0...+15			
		[°F]	+32...+59					+32...+59			
	ST	[°C]	+3...+70								
		[°F]	+37...+158								
Temperature resolution [°C]	every 0,1										
Controller	microprocessor with external touch screen										
Interior	Smart P	stainless steel according to DIN 1.4301									
	Smart PS	stainless steel according to DIN 1.4301									
Housing	Smart P	powder coated sheet									
	Smart PS	polished stainless steel									
Overall dims ² [mm]	A width	570	620	620	620	620	660	750	1480	1460	
	B height	660	900	1100	1300	1500	1900	1990	1990	1940	
	C depth	680	650	650	650	650	650	810	860	860	
Internal dims ³ [mm]	D width	430	480	480	480	480	480	540	1270	1270	
	D' width	470	520	520	520	520	520	600	1340	1340	
	E height	430	660	860	1060	1260	1660	1510	1510	1460	
	F depth	300	420	420	420	420	420	610	680	680	
	F' depth	360	480	480	480	480	480	-	-	-	
	G depth	-	320	320	320	320	320	-	-	-	
	H height	-	440	640	840	1040	1440	-	-	-	
	I height	-	-	-	-	-	-	1360	1360	1360	
Max shelf workload ⁴ [kg]	-	10	10	10	10	10	20	30	30	30	
	version PW ⁵	on request					100	100	100	100	
Max unit workload [kg]	-	20	30	40	50	60	60	100	150	300	
	version W ⁶	on request									
Nominal power	consult rating plate of the device										
Total maximum load power of electrical sockets (option)	Σ_{max} 200 [W]										
Weight [kg]	32	54	59	69	75	90	105	115	185	200	
Protection	ST	class 3.3 according to DIN 12880									
	CHL	class 3.2 according to DIN 12880									
Power supply	consult rating plate of the device ⁷										
Shelves fitted/max	2/2	3/4	3/4	4/6	4/7	4/10	3/11	3/11	2x3/11	2x3/11	
Refrigerant	consult rating plate of the device										
Door number	1	1	1	1	1	1	1	1	2	2	
Warranty	24 months										
Manufacturer	POL-EKO										

1. additional internal glass door
2. depth does not include 50mm of power cable
3. internal dimensions of the units with double door are always smaller
4. on uniformly loaded surface
5. reinforced shelf
6. reinforced version (extra paid option)
7. the rating plate is located on the left side of the device in the upper left corner

16.2. ST M, CHL M devices with monoblock

Parameter		ST500 M CHL500 M	ST700 M CHL700 M	ST1200 M CHL1200 M	ST1450 M CHL1450 M
Air convection		forced			
Chamber capacity [l]		500	625	1365	1540
Working capacity [l]		469	611	1355	1525
Door		solid / glass door or double ¹ (option)			
Temperature range [°C]	CHL	[°C]	0...+15		
		[°F]	+32...+59		
	ST	[°C]	+3...+40 / do +70 (option)		
		[°F]	+37...+104 / do +158 (option)		
	ST BD	[°C]	+3...+40		
		[°F]	+37...+104		
Temperature resolution [°C]		every 0,1			
Controller		microprocessor with external touch screen			
Interior	Smart B	aluminium			
	Smart C	stainless steel according to DIN 1.4016			
	Smart CS	stainless steel according to DIN 1.4016			
	Smart P	stainless steel according to DIN 1.4301			
	Smart PS	stainless steel according to DIN 1.4301			
Housing	Smart B	powder coated sheet			
	Smart C	powder coated sheet			
	Smart CS	polished stainless steel			
	Smart P	powder coated sheet			
	Smart PS	polished stainless steel			
Overall dims ² [mm]	A width	660	750	1480	1460
	B height	1990	1990	1990	1940
	C depth	810	860	860	960
Internal dims ³ [mm]	D width	480	540	1270	1270
	D' width	510	600	1340	1340
	E height	1510	1510	1510	1460
	F depth	610	680	680	780
	F' depth	-	-	-	-
	G depth	-	-	-	-
	H height	-	-	-	-
	I height	1380	1380	1380	1380
Max shelf workload ⁴ [kg]	-	20	30	30	30
	version PW ⁵	100	100	100	100
Max unit workload [kg]	-	100	150	300	300
	version W ⁶	on request			
Nominal power		consult rating plate of the device			
Total maximum load power of electrical sockets (option)		$\Sigma_{max.} 200$ [W]			
Weight ⁸ [kg]		105	115	185	200
Protection		class 1.0 according to DIN 12880 / class 3.3 (option)			
Power supply		230 [V] ±10% / 50 [Hz]			
Shelves fitted/max		3/11	3/11	2x3/11 ⁹	2x3/11 ⁹
Refrigerant		consult rating plate of the device			
Door number		1	1	2	2
Warranty		24 months			
Manufacturer		POL-EKO			

1. additional internal glass door
2. depth does not include 50mm of power cable
3. internal dimensions of the units with double door are always smaller
4. on uniformly loaded surface
5. reinforced shelf
6. reinforced version (extra paid option)
7. the rating plate is located on the left side of the device in the upper left corner
8. for the units with solid door in SMART version

16.3. ST, CHL multi-chamber devices

Parametr			ST1/1 CHL1/1	ST1/1/1 CHL1/1/1	ST2/2 CHL2/2	ST2/3 CHL2/3
Air convection			forced			
Chamber capacity [l]			70/70	70/70/70	150/150	150/200
Working capacity [l]			55/55	55/55/55	122/122	122/163
Door			solid / glass door or double ¹ (option)			
Temperature range [°C]	CHL	[°C]	0...+15			
		[°F]	+32...+59			
	ST	[°C]	+3...+ 70			
		[°F]	+37...+158			
Temperature resolution [°C]			every 0,1			
Controller			microprocessor with external touch screen			
Interior	Smart P		stainless steel according to DIN 1.4301			
	Smart PS		stainless steel according to DIN 1.4301			
Housing	Smart P		powder coated sheet			
	Smart PS		polished stainless steel			
Overall dims ² [mm]	A width		570	570	620	620
	B height		1290	1920	1720	1910
	C depth		680	680	650	650
Internal dims ³ [mm]	D width		430	430	480	480
	D' width		470	470	520	520
	E height		430	430	660	660/860
	F depth		300	300	420	420
	F' depth		360	360	480	480
	G depth		-	-	320	320
Max shelf workload ⁴ [kg]	-		10	10	10	10
	version PW ⁵		on request			
Max unit workload [kg]	-		20	30	40	50
	version W ⁶		on request			
Nominal power ⁷ [W]			consult rating plate of the device			
Weight [kg]			65	98	109	114
Protection	CHL		class 3.2 according to DIN 12880			
	ST		class 3.3 according to DIN 12880			
Power supply			consult rating plate of the device ⁷			
Shelves fitted/max			see table for single chamber devices			
Total maximum load power of electrical sockets (option)			$\Sigma_{max.} 200 [W]$			
Refrigerant			consult rating plate of the device ⁷			
Warranty			24 months			
Manufacturer			POL-EKO			

1. additional internal glass door
2. depth does not include 50mm of power cable
3. internal dimensions of the units with double door are always smaller
4. on uniformly loaded surface
5. reinforced shelf
6. reinforced version (extra paid option)
7. the rating plate is located on the left side of the device in the upper left corner

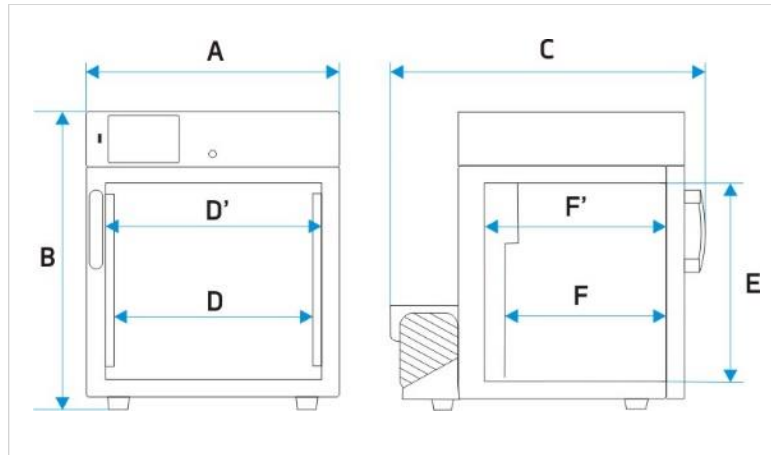

ST 1, CHL 1

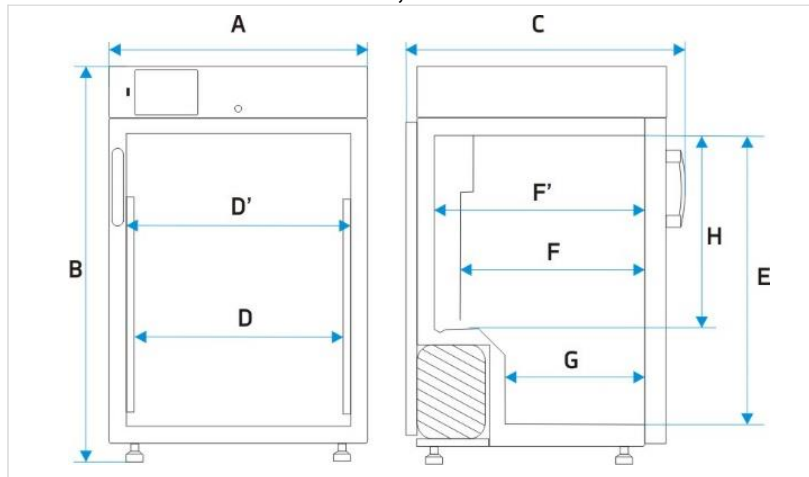

ST / CHL: 2,3,4,5,6

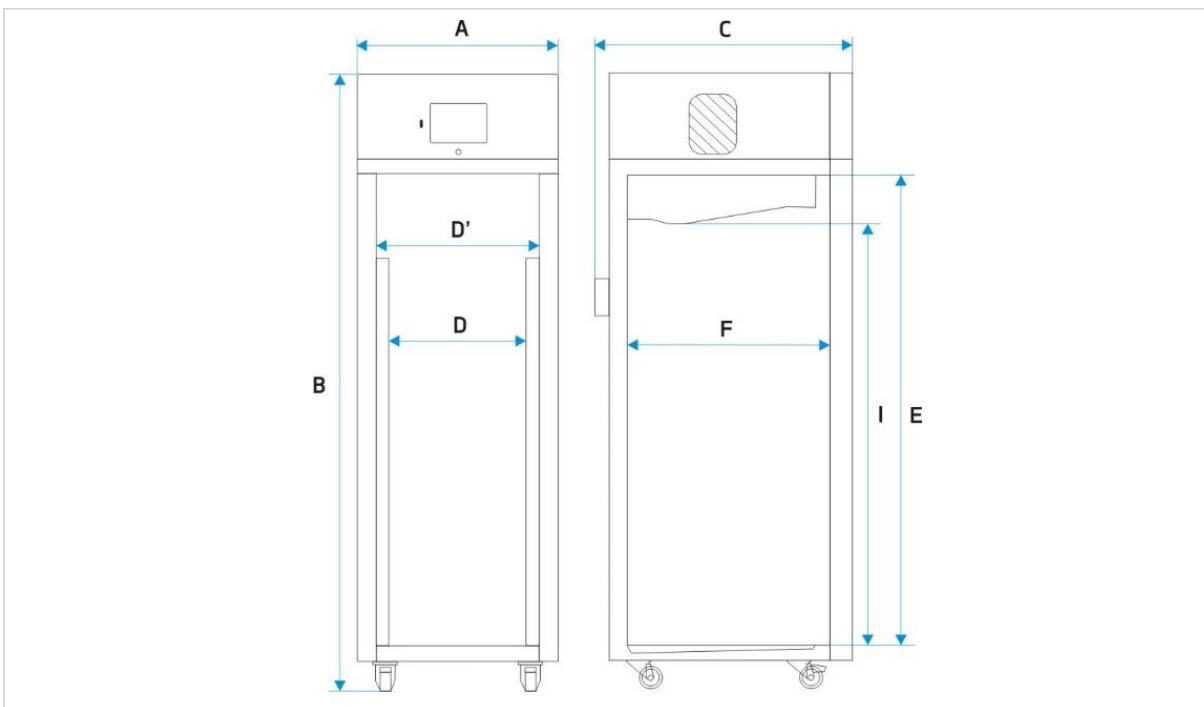

ST / CHL 500, 700, 1200, 1450

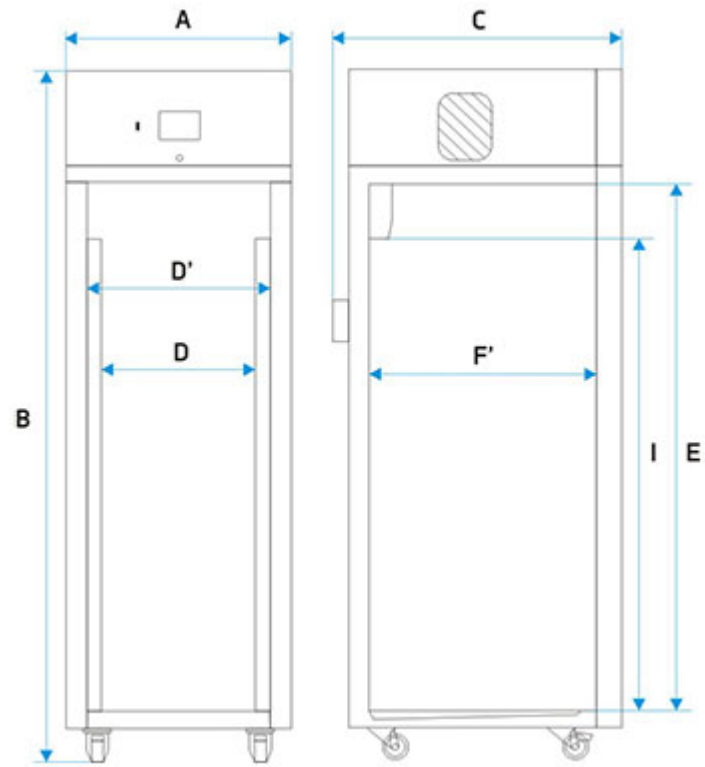

ST / CHL 500 M, 700 M, 1200 M, 1450 M



16.4. ILW devices

Parameter		ILW53	ILW115	ILW240	ILW400	ILW750
Air convection		forced				
Chamber capacity [l]		56	112	245	424	749
Door		double / with viewing window (option)				
Temperature range [°C]		0...+100 /-10...+100 (option)				
Temperature range [°F]		+32...+212 / +14...+212				
Temperature resolution [°C]		every 0,1				
Controller		microprocessor with external touch screen				
Interior		acid-proof stainless steel according to DIN 1.4301				
Housing	Smart	powder coated sheet				
	IG Smart	stainless steel linen finish				
Overall dims ¹ [mm]	A width	610	660	820	1040	1260
	B height	960	1100	1430	1680	1910
	C depth	630	720	720	780	880
Internal dims [mm]	D width	400	460	600	800	1040
	E height	390	540	800	1040	1200
	F depth	360	450	510	510	600
Max shelf workload ⁴ [kg]	-	25	25	25	25	-
	version PW ²	50	50	100	100	100
Max unit workload [kg]	-	40	60	90	120	140
	version W ³	80	120	300	300	300
Nominal power [W]		consult rating plate of the device				
Weight [kg]		69	90	140	185	275
Protection		class 3.3 according to DIN 12880				
Power supply		consult rating plate of the device ⁵				
Shelves fitted/max		2/5	2/7	3/10	3/14	5/16
Warranty		24 months				
Manufacturer		POL-EKO				

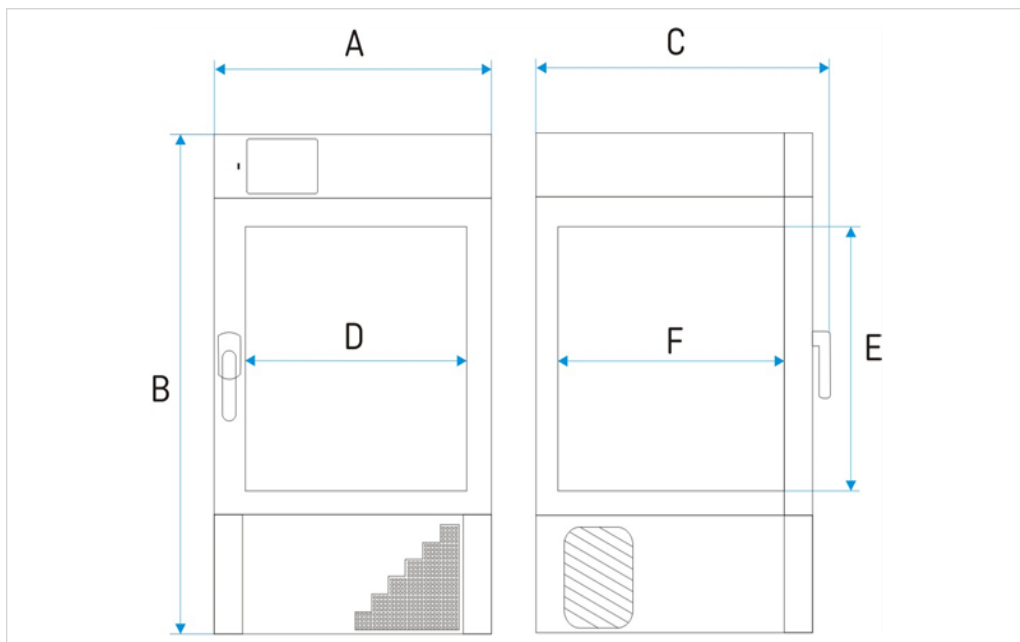
- depth does not include 50mm of power cable
- reinforced shelf
- reinforced version
- on uniformly loaded surface
- the rating plate is located on the left side of the device in the upper left corner



17. DECLARATIONS OF CONFORMITY

 DEKLARACJA ZGODNOŚCI UE EU DECLARATION OF CONFORMITY		 POL-EKO
Produkt:	Product:	
Chłodziarka laboratoryjna	Laboratory refrigerators	
Model:	Model:	
CHL 1; CHL 2; CHL 3; CHL 4; CHL 5; CHL 6; CHL 500; CHL 700; CHL 1200; CHL 1450; CHL 1/1; CHL 1/1/1; CHL 2/2; CHL 2/3; CHL 2/4; CHL 3/3; CHL2/ZLN85+; CHL3/ZLN85+		
w wersjach:	in version:	
B SMART; C SMART; CS SMART; P SMART; PS SMART; P Smart PRO; PS SMART PRO BM SMART; CM SMART, CMS SMART; PM SMART; PMS SMART; PM SMART PRO; PMS SMART PRO z opcją/with option TR		
Nazwa i adres producenta:	Name and address of the manufacturer:	
POL-EKO A.Polok-Kowalska sp.k. ul. Kokoszycka 172 C 44-300 Wodzisław Śląski Polska/Poland		
Niniejsza deklaracja zgodności wydana zostaje na wyłączną odpowiedzialność producenta.	This declaration of conformity is issued under the sole responsibility of the manufacturer.	
Wymieniony powyżej przedmiot niniejszej deklaracji jest zgodny z odnośnymi wymaganiami unijnego prawodawstwa harmonizacyjnego:	The object of the declaration described above is in conformity with the relevant Union harmonisation legislation:	
LVD 2014/35/UE	LVD 2014/35/EU	
EMC 2014/30/UE	EMC 2014/30/EU	
RoHS 2015/863	RoHS 2015/863	
WEEE 2012/19/UE	WEEE 2012/19/EU	
Odniesienia do odnośnych norm zharmonizowanych, które zastosowano lub do innych specyfikacji technicznych, w stosunku, do których deklarowana jest zgodność:	References to the relevant harmonised standards used or references to the other technical specifications in relation to which conformity is declared:	
LVD	PN-EN 61010-1:2011 PN-EN 61010-2-010:2015-01 PN-EN 60529:2003/A2:2014-07	
EMC	PN-EN IEC 61326-1:2021-10	
RoHS	PN-EN IEC 63000:2019-01	
Wodzisław Śl. 02.01.2023		W imieniu producenta podpisał:  Małgorzata Szafarczyk Dyrektor Generalny (CEO)



DEKLARACJA ZGODNOŚCI UE
EU DECLARATION OF CONFORMITY



Produkt: Szafa termostatyczna	Product: Cooled incubator (ST)
Model:	Model:
ST 1; ST 2; ST 3; ST 4; ST 5; ST 6; ST 500; ST 700; ST 1200; ST 1450; ST 1/1; ST 1/1/1; ST 2/2; ST 2/3; ST 2/4; ST 3/3; ST2/ZLN85; ST3/ZLN85; ST 2 BD; ST 4 BD; ST 5 BD; ST 2 BD A; ST 4 BD A; ST 5 BD A	
w wersjach:	in version:
B SMART*; C SMART; CS SMART; P SMART; PS SMART; P SMART PRO; PS SMART PRO BM SMART; CM SMART, CMS SMART; PM SMART; PMS SMART; PM SMART PRO; PMS SMART PRO z opcją/with option TR	
Nazwa i adres producenta:	Name and address of the manufacturer:
POL-EKO A.Polok-Kowalska sp.k. ul. Kokoszycka 172 C 44-300 Wodzisław Śląski Polska/Poland	
Niniejsza deklaracja zgodności wydana zostaje na wyłączną odpowiedzialność producenta.	This declaration of conformity is issued under the sole responsibility of the manufacturer.
Wymieniony powyżej przedmiot niniejszej deklaracji jest zgodny z odnośnymi wymaganiami unijnego prawodawstwa harmonizacyjnego:	The object of the declaration described above is in conformity with the relevant Union harmonisation legislation:
LVD 2014/35/UE EMC 2014/30/UE RoHS 2015/863 WEEE 2012/19/UE	LVD 2014/35/EU EMC 2014/30/EU RoHS 2015/863 WEEE 2012/19/EU
Odniesienia do odnośnych norm zharmonizowanych, które zastosowano lub do innych specyfikacji technicznych, w stosunku, do których deklarowana jest zgodność:	References to the relevant harmonised standards used or references to the other technical specifications in relation to which conformity is declared:
LVD	PN-EN 61010-1:2011 PN-EN 61010-2-010:2015-01 PN-EN 60529:2003/A2:2014-07
EMC	PN-EN IEC 61326-1:2021-10
RoHS	PN-EN IEC 63000:2019-01

W imieniu producenta podpisał:

M. Hofarczyk
 Malgorzata Szafarczyk
 Dyrektor Generalny (CEO)

Wodzisław Śl. 02.01.2023



DEKLARACJA ZGODNOŚCI UE
EU DECLARATION OF CONFORMITY



Produkt:	Product:
Inkubator z chłodzeniem	Cooled incubator
Model:	Model:
ILW 53; ILW 115; ILW 240; ILW 400; ILW 750	
w wersjach:	in version:
SMART; IG SMART; SMART PRO; IG SMART PRO	
Nazwa i adres producenta:	Name and address of the manufacturer:
POL-EKO A.Polok-Kowalska sp.k. ul. Kokoszycka 172 C 44-300 Wodzisław Śląski Polska/Poland	
Niniejsza deklaracja zgodności wydana zostaje na wyłączną odpowiedzialność producenta.	This declaration of conformity is issued under the sole responsibility of the manufacturer.
Wymieniony powyżej przedmiot niniejszej deklaracji jest zgodny z odnośnymi wymaganiami unijnego prawodawstwa harmonizacyjnego:	The object of the declaration described above is in conformity with the relevant Union harmonisation legislation:
LVD 2014/35/UE EMC 2014/30/UE RoHS 2015/863 WEEE 2012/19/UE	LVD 2014/35/EU EMC 2014/30/EU RoHS 2015/863 WEEE 2012/19/EU
Odniesienia do odnośnych norm zharmonizowanych, które zastosowano lub do innych specyfikacji technicznych, w stosunku, do których deklarowana jest zgodność:	References to the relevant harmonised standards used or references to the other technical specifications in relation to which conformity is declared:
LVD	PN-EN 61010-1:2011 PN-EN 61010-2-010:2015-01 PN-EN 60529:2003/A2:2014-07
EMC	PN-EN IEC 61326-1:2021-10
RoHS	PN-EN IEC 63000:2019-01

Wodzisław Śl. 02.01.2023

W imieniu producenta podpisał:

M. Kofarczyk
Małgorzata Szafarczyk
Dyrektor Generalny (CEO)

Instruction manual ST, CHL, ILW SMART PRO

Manufacturer of control and measurement equipment
for laboratory tests and technological processes,
distributor in Poland of the following companies:
HAMILTON, NICKEL ELECTRO, RODWELL, THERMO SCIENTIFIC, WTW.

We produce:

- thermostatic cabinets
- laboratory refrigerators
- laboratory incubators
- devices with photoperiod and phytotron system
- drying ovens and sterilizers
- drying ovens with nitrogen blow
- laboratory freezers
- ultra-low freezers
- climatic chambers
- Caldera fluid and blanket warmers
- colony counters
- laboratory shakers
- stationary samplers
- Hydromat water dispensers
- Eurodrop stations
- FEKO+ waste water receipt station
- heating ovens
- cooled incubators
- fume hoods

We organize:

- regional trainings
- individual trainings
- seminars

We provide:

- warranty and post-warranty service
- consultancy in the selection, maintenance and operation of laboratory equipment

POL-EKO LAB is Accredited by the Polish Centre for Accreditation (a member of ILAC) and provides accredited calibration of:

- thermostatic and climatic chambers (incubators, drying ovens, thermostatic cabinets, climatic chambers, freezers)
- water baths and thermo reactors
- autoclaves
- electric and electronic thermometers
- data loggers
- high temperature laboratory furnaces
- thermohygrometers
- laboratory sieves

Calibration is confirmed with the issue of 'Calibration Certificate'.

Services outside the scope of accreditation:

- checking equipment for physicochemical measurements (meters and probes),
- carrying out IQ, OQ, PQ qualification procedures,
- mapping of temperature and humidity in the rooms

We offer portable, laboratory and on-line equipment:

- pH-meters
- ionmeters
- dissolved oxygen meters
- conductivity meters
- photometers and spectrophotometers
- thermo reactors
- turbidity metres
- pH electrodes
- conductivity sensors
- oxygen probes
- heavy metals trace analyzers
- water baths
- autoclaves
- pH buffer solutions
- conductivity standards
- photometric tests
- laboratory accessories
- consumables



AP 115



POL-EKO
Perfect Environment

☎ (+48) 32 453 91 70
✉ info@pol-eko.com.pl
🌐 www.pol-eko.com.pl

📍 **POL-EKO A. Polok – Kowalska sp.k.**
44-300 Wodzisław Śląski
ul. Kokoszycka 172 C

