



# **Shaking Water Bath LSB Aqua Pro**

## *Operating Manual*

www.grantinstruments.com  
salesdesk@grantinstruments.com  
Tel: +44 (0)1763 260811

If you have any feedback on Grant's products or services we would like to hear from you.  
Please send all feedback to:

Grant Instruments (Cambridge) Ltd  
Shepreth  
Cambridgeshire  
SG8 6GB  
UK

Tel: +44 (0) 1763 260 811  
Fax: +44 (0) 1763 262 410  
E-mail: [support@grantinstruments.com](mailto:support@grantinstruments.com)

Representative in the European Union  
Grant Instruments Europe B.V  
Strawinskylaan 411  
WTC, Tower A, 4th Floor  
1077 XX, Amsterdam  
The Netherlands

E-mail: [grant@eu.grantinstruments.com](mailto:grant@eu.grantinstruments.com)

## Contents

1	Use of products	4
2	How to use this operating manual	4
3	Product registration and warranty	4
4	Safety information	5
4.1	Safety symbols	5
4.2	Safety warnings	5
5	Operating instructions	7
5.1	Unpacking instructions	7
5.2	Installation	7
5.3	Electrical supply	7
5.4	Selecting and configuring trays and racks	7
5.5	Fitting the shaking trolley and a tray	9
6	Operating procedures	10
6.1	Bath liquids	10
6.2	Liquid level	10
6.3	Run-dry protection	11
6.4	Operation above 60°C	12
6.5	Achieving high temperature accuracy when shaking is used	12
6.6	Use as a thermostatic bath without shaking	12
6.7	Emptying the baths	12
7	Using the shaking water bath	13
7.1	Bath controls	13
7.2	Indicators	13
7.3	Setting the control temperature (°C)	14
7.4	Setting the shaking speed	14
7.5	Stopping and starting the shaking	16
7.6	Enabling the keypad lock	16
7.7	Setting the over temperature protection (OTP)	17
7.8	Configuring and running temperature and shaking speed presets (Pr 1, Pr 2)	18
7.9	Running temperature presets (Pr 1, Pr 2)	19
7.10	Setting the countdown timer (CdT)	19
8	Calibration	21
8.1	Calibration options	21
8.2	Single point calibration (LPC)	21
8.3	Dual point calibration (LPC, HPC)	23
9	Technical specification	26
10	Technical tips	27
10.1	Which water should you use in your bath?	27
10.2	Troubleshooting guide	28
11	Warranty information	28
12	Maintenance and service	29
12.1	Cleaning	29
12.2	Fuses	29
12.3	Replacing the mains cord	29
12.4	Routine safety tests	29
12.5	Service	30
13	Compliance	30

## 1 Use of products

---

The following products are covered by this operating manual:

### **LSB Aqua Pro range:**

LSB12, LSB12 AUS, LSB12 US, LSB18, LSB18 AUS, LSB18 US,

The products listed above are a general purpose series of thermostatically controlled linear and orbital shaking water baths designed for indoor laboratory use by a professional user.

## 2 How to use this operating manual

---

This operating manual will allow you to unpack, set up and operate this water bath correctly and safely. Important safety information, symbols and warnings are listed below and should be read carefully.

If there is a technical matter that this operating manual does not address, or any other questions concerning this product, please contact Grant Instruments or your local distributor who will be able to provide any additional information.

English is the original language of this manual

## 3 Product registration and warranty

---

The warranty for this water bath is detailed in section 8 but to register you should complete the on-line registration form at [www.grantinstruments.com](http://www.grantinstruments.com). **Not registering your product may affect your warranty.**

## 4 Safety information

---

### 4.1 Safety symbols

The symbols below are marked on the equipment to indicate:



**Caution: Surfaces and water can be hot during and after use**



**Read this manual before using the bath**



**Important safety warning**



**Recommended operation  
Failure to follow may affect the performance of the equipment**

### 4.2 Safety warnings

	Read the whole of the instructions. Safety may be impaired if they are not followed.
 	<p>Surfaces and water can be hot during and after use. Allow the liquid temperature to fall to a safe level before emptying. Empty the bath before moving it.</p> <p>This bath is only intended for use with water. Use of other fluids or heat transfer media may invalidate the warranty and present a risk of fire or explosion.</p> <p>Place on a stable flat surface to reduce the risk of accidental spillage.</p> <p>No user serviceable parts. Risk of electric shock after disassembly or operation with covers removed.</p> <p>Not for use in environments with a risk of flammable or explosive gases. To be operated within the limits listed in this guide</p> <p>Do not use the bath to heat any material that could cause a fire or any other kind of hazard.</p> <p>Take care when operating after a power interruption as shaking will restart at the previous speed.</p> <p>There are accessible moving parts in the bath. Observe safe working practises when operating a shaking bath. Users should not interfere with moving parts when in use and prevent accidental contact from items such as fingers, hair or clothing.</p> <p>Only use the mains cord provided or one with an identical rating. Ensure that the mains plug and the switch are easily accessible.</p>

	<p>A clearance of &gt;10cm around the bath is required to ensure adequate air flow.</p> <p>If a potentially hazardous liquid is spilt onto the equipment, disconnect it from the power supply and have it checked by a competent person. It is the user's responsibility to carry out appropriate decontamination if hazardous material is spilt on the equipment.</p> <p>Clean the outside of the equipment with a damp cloth, using water and domestic cleaning products only. The use of other chemical cleaning agents may damage the equipment. Always follow the manufacturer's instructions and any applicable legislation about the use of potentially hazardous substances.</p>
	<p>Before first switching on the bath please remember to fill the bath with water. Switching the bath on dry can damage the heater and could invalidate the product warranty.</p> <p>If the equipment has been transported or stored in cold or humid conditions, condensation may form inside it. If that could have happened, allow time (at least 2 hours at room temperature) for the condensation to evaporate before using the equipment.</p> <p>Restricting or interfering with the tray motion in the bath may reduce performance and reduce reliability</p> <p>To preserve your water bath in peak condition consult the extra guidance listed in this manual. Failure to do so may affect your warranty. Consult online resources for additional important information.</p>

## 5 Operating instructions

---

### 5.1 Unpacking instructions

Standard equipment includes:

- Shaking water bath
- Shaking trolley
- Universal shaking tray
- Drive magnet
- Mains cord with plug
- Gabled polycarbonate lid
- Short user guide

Remove packing materials carefully, and retain for future shipment or storage of the equipment.

### 5.2 Installation

Place the water bath on a level, non-combustible surface. Ensure that the mains plug and the switch are easily accessible.

A clearance of >10cm around the bath is required to ensure adequate air flow.

### 5.3 Electrical supply

Check that the supply voltage marked on the serial number label, and the type of mains plug, are correct for your mains supply outlet, which must have an Earth (Ground) connection.

To disconnect the equipment from the mains supply, remove the mains plug from the mains supply outlet.

### 5.4 Selecting and configuring trays and racks

The bath is supplied with a Universal shaking tray. Different types of shaking trays are available to hold different vessel types. These can be purchased separately. See [www.grantinstruments.com](http://www.grantinstruments.com) for a full list of accessories.

Part number	Description
TU12	Universal tray with adjustable springs, supplied with each LSB12. Highly versatile for a variety of vessel types.
TU18	Universal tray with adjustable springs, supplied with each LSB18. Highly versatile for a variety of vessel types.
TF12	Flask tray with threaded holes to hold 25 - 1000ml flask clamps, racks and deep well plate holder (see options below) for LSB12
TF18	Flask tray with threaded holes to hold 25 - 1000ml flask clamps, racks and deep well plate holder (see options below) for LSB18
TS12	Test tube tray compatible with SR test tube and microtube racks (see options below) for LSB12. Holds up to 3 SR racks
TS18	Test tube tray compatible with SR test tube and microtube racks (see options below) for LSB18. Holds up to 5 SR racks

Flask clamps and plate holder			
Part number	Description	TF12 capacity	TF18 capacity
SC-25	For 25ml flask	18	33
SC-50	For 50ml flask	14	26
SC-100	For 100ml flask	9	17
SC-250	For 250ml flask	5	14
SC-500	For 500ml flask	4	6
SC-1000	For 1000ml flask	2	4
SH-DWP	For 1 x deep well plate ( $\geq 2$ ml)	2	4

Test tube rack /microtube rack		
Part number	Tube diameter (mm)	Rack capacity
SR-10	10	48
SR-13	13	44
SR-16	16	24
SR-19	19	21
SR-25	25	12
SR-30	30	10
Part number	Micrstitute size (ml)	Rack capacity
SR-SE	0.5	119
SR-LE	1.5	48

Configure the tray to hold in place the type of vessel being used.

The number flasks and vessels that can be fitted to each tray along with the suggested position of holding springs and flask clamps is available online at [www.grantinstruments.com](http://www.grantinstruments.com)



## 5.5 Fitting the shaking trolley and a tray

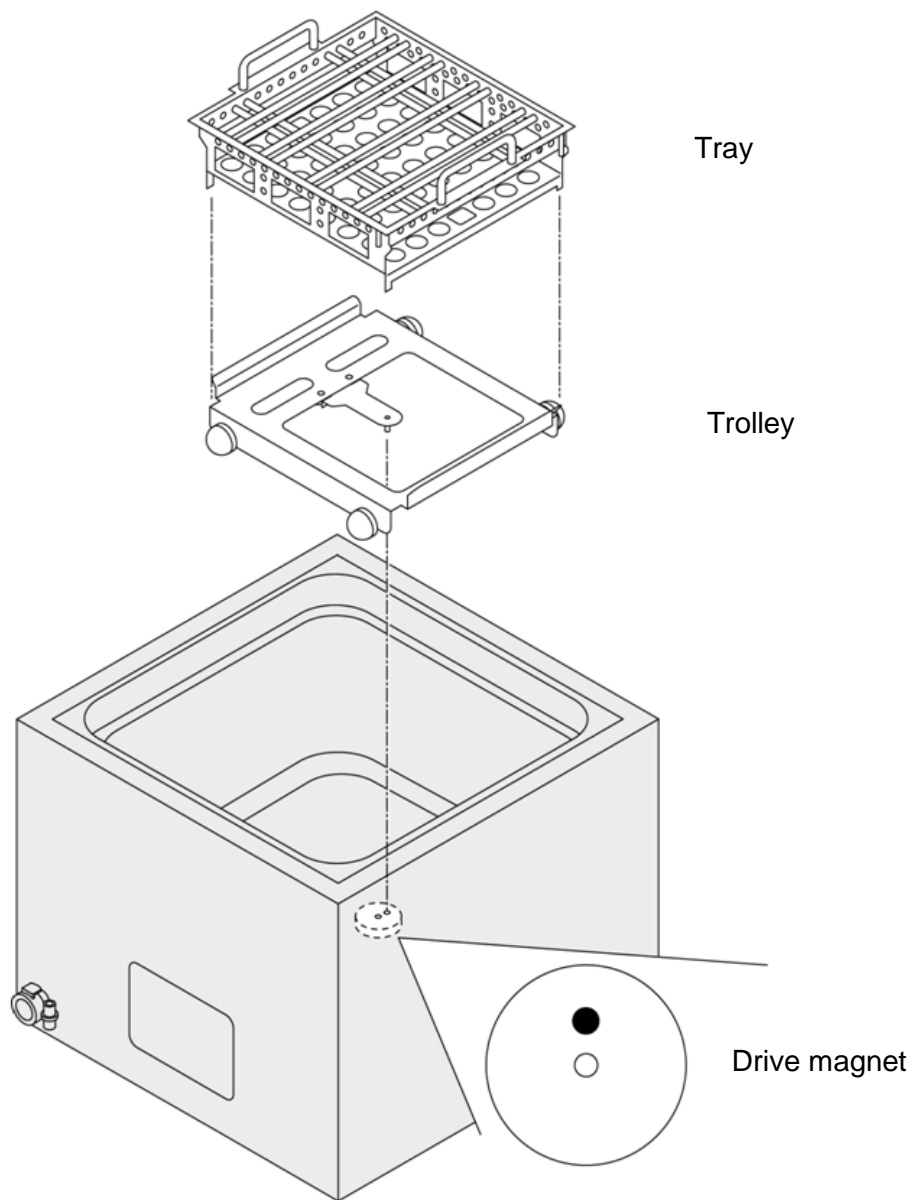

Locate the trolley arm pin into the hole on the drive magnet

The tray can now be lowered directly on to the trolley and will be held in place

## 6 Operating procedures

---

### 6.1 Bath liquids

Water is the only liquid permitted for use in the LSB Aqua Pro.  
See section 7.1 for more information

### 6.2 Liquid level

The best liquid level for your bath depends on the application and several factors must be considered:

- When the shaking function is not in use the bath will provide optimum performance when filled to the swage line which is typically 25mm below the top of the tank.
- The water level used in the tank will influence the temperature accuracy and stability. Using liquid levels below the swage line needs consideration, especially when operating at higher water temperatures (>50°C) and without a lid.
- When the shaking function is used the optimum liquid level depends on:
  - The tray type and vessel type in use.
  - The shaking mode and shaking speed
  - The minimum level which keeps the samples covered all the time and therefore allows their temperature to be properly controlled
- For a given shaking setting (speed/stroke length/orbital or linear) there will be a practical maximum level above which fluid from the bath will be pushed over the sides of the bath by the motion of the vessels.

Do not fill above the swage line.

Grant recommends the following minimum fill levels

Bath	Recommended minimum fill	Approximate water depth
LSB12	5 litre	60mm
LSB18	7.5 litre	60mm

**Table 1 - Recommended minimum fill levels**

	<p><b>Do not attempt to use your bath without water in the tank.</b></p> <p>The bath has an inbuilt protection mechanism known as dry start protection which will detect if the bath is started without any water, in most circumstances, and prevent the bath from continuing to heat. In this instance the bath will display <i>dry</i> and sound an alarm.</p> <p>Switch the bath off before filling it with water and switching on again. The bath will not resume operation without being turned off and on again..</p>
---	--



The tank internal surface can become very hot if an accidental dry start has occurred, even if the dry start cut out has operated. Avoid touching the tank until it has been left to cool for several minutes.

Refill carefully, a hot heater can cause a spattering of very hot water droplets and scalding steam



Repeated dry starting of the bath stresses key components in the bath which can affect service life and the equipment's warranty.



#### **Allowing the bath to run dry**

Always take care to avoid allowing the water to evaporate to the point that the bath runs dry. This can lead to the bath's internal safety cut-out operating requiring a suitable qualified technician to reset it.

### **6.3 Run-dry protection**

The bath has a built-in advanced detection mechanism to greatly reduce the chances of the safety cut out occurring in most circumstances where the bath is left to accidentally run dry. This feature is only enabled automatically when the following criteria are met:

- The set temperature is  $>50^{\circ}\text{C}$
- The bath has been operating for a least one hour
- The water is not set to boiling point ( $\geq 99^{\circ}\text{C}$ )

If the bath detects signs that the bath water level may be becoming low, it will alert the user by displaying *dry* and sounding an alarm

Once you have checked the water level and topped up the water level as necessary you will need to switch the bath off and on in order to resume operation.

For users with specialist applications where this feature may be unnecessarily triggered it can be disabled. Press the set key to enter the bath menu and use the arrow keys to select *dPA* (Dry Protection Alarm). Press the set key and use the arrow keys to select off. Use the set key to confirm that the dry start and run dry protection are switched off.

The bath also includes an independent safety temperature cut-out which will protect the bath in the unlikely event of a fault or if the dry protection alarm is switched off. If the cut-out is activated then the bath will stop heating, show *EE* on the display and sound an alarm. The bath should be switched off, unplugged and allowed to cool for at least 30 minutes. The cut-out can only be reset by a suitably qualified technician who must verify that the bath has not been damaged.

## 6.4 Operation above 60°C

The lid must be used above 60°C to maintain proper temperature control and to ensure that the water temperature reaches the set point. The lid will also prevent excessive evaporation that requires the bath to be filled more often and will save energy.

The lid should only be lifted by the handle, as other parts can become hot during use. It also has a vent/thermometer hole – this hole should not be sealed as pressure could build up inside the bath.

## 6.5 Achieving high temperature accuracy when shaking is used

To achieve higher accuracy and temperature stability, Grant recommends the bath is calibrated with the bath running at the shaking speed typically used.

Single and dual point calibration options can be set. See Section 8.



When operating above 70°C, Grant recommends a minimum shaking speed of 50 rpm.

	Restricting or interfering with the tray motion in the bath may reduce performance and reduce reliability
---	---

## 6.6 Use as a thermostatic bath without shaking

If the shaking trolley and drive magnet are lifted out, a shaking bath can be used as a simple thermostatic bath. When used in this way, if flat bottomed vessels or objects are to be placed in the bath, always use a steel base tray (optional accessory) to avoid damage to the under-tank heater.

## 6.7 Emptying the baths

	Allow the liquid temperature to fall to a safe level before emptying. Take reasonable precautions to prevent accidental spillage.
	If the bath is drained at temperatures above 50°C then the drain mechanism will be damaged and will need to be replaced.

Baths have drain taps to make emptying easier. To empty the bath using the drain tap, push the supplied drain insert into the drain tap. Note that the water will begin to empty as soon as the drain insert is fully engaged. A length of hose can be added to the barbed end of the drain insert if required.

## 7 Using the shaking water bath

### 7.1 Bath controls

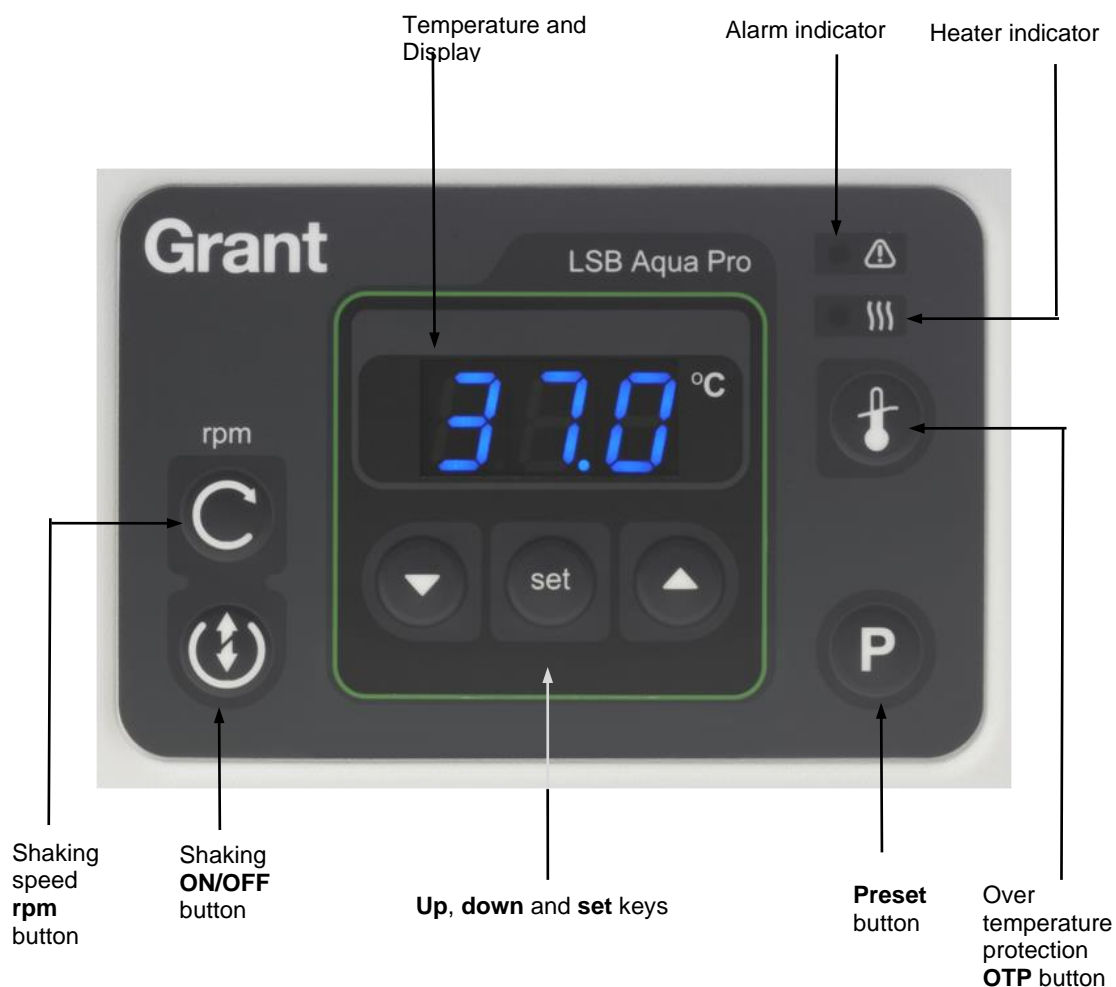

**Figure 1 – LSB Aqua Pro front panel controls**

The mains on/off switch is at the rear of the unit

### 7.2 Indicators

There are three indicators:

- Main display – used to show temperature, shaking speed and short messages
- Heater – Illuminated when the bath is heating
- Alarm - flashes red when activated. A buzzer also sounds.

### 7.3 Setting the control temperature (°C)

The water temperature of the bath can be set using the main display. The following example shows setting the water bath to 37.0°C.



Figure 2 - Setting the control temperature

### 7.4 Setting the shaking speed

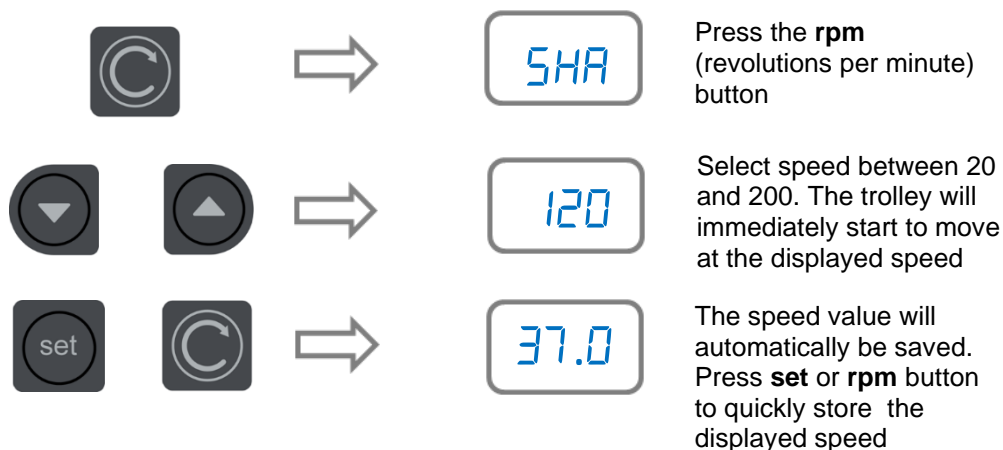

Figure 3 - Setting the shaking speed

The shaking speed can be checked at anytime by pressing the rpm button. The speed is displayed for 2 seconds.

The bath shaking speed is dependent on how much the tray is loaded. If the shaking speed is set too high for a given tray load then the motion will judder and become erratic. If this happens, either reduce the shaking speed or the tray load until the motion becomes smooth and consistent.

The following graphs show the shaking speed range achievable under certain tray loads and can be used for guidance. The graphs were created using Erlenmeyer flasks with a fill depth of 90mm. Factors such as fill level and vessel type will influence the maximum speed achievable. Best performance will be achieved where vessels are held securely.

LSB12

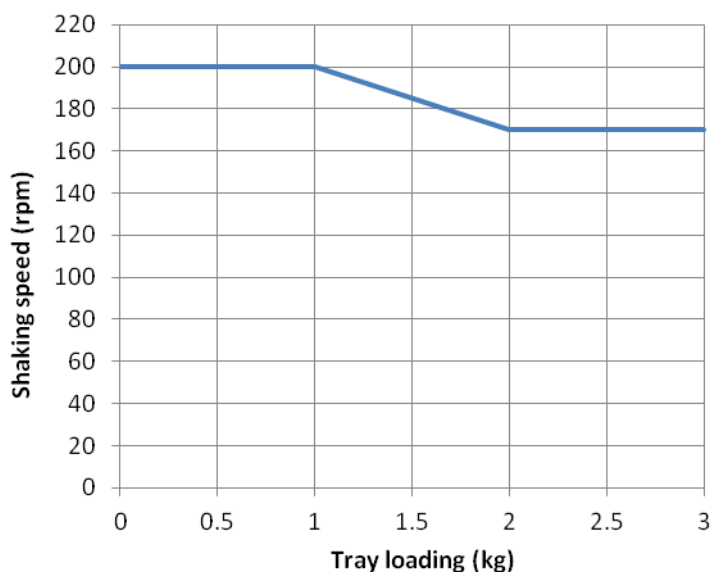

LSB18

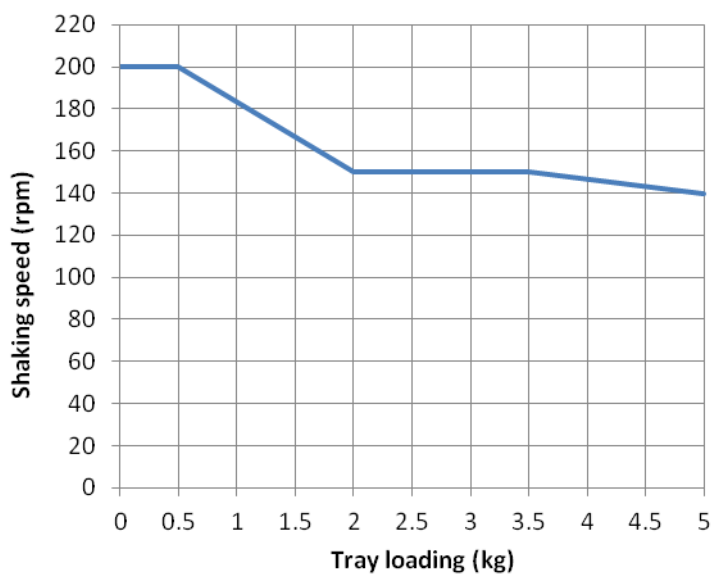

If the shaking speed is changed by more 40rpm during operation, allow half an hour for the bath liquid temperature to stabilise.

When above 70°C the recommended minimum shaking speed is 50 rpm to maintain temperature accuracy and stability.

## 7.5 Stopping and starting the shaking

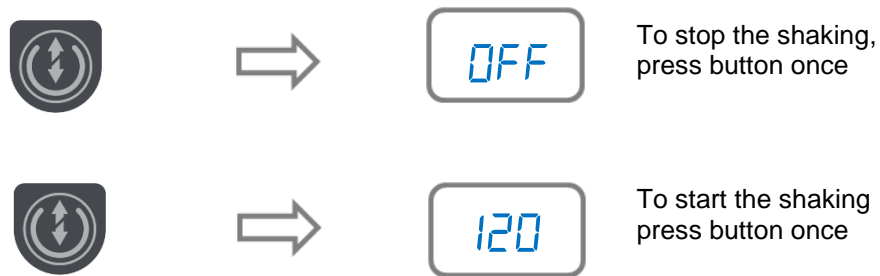

**Figure 4 – Stopping and starting the shaking**

The shaking will start at the speed previously set using the rpm button. If no speed has been set then the display will show *OFF* when start is pressed.

## 7.6 Enabling the keypad lock

The keypad lock is intended to help users avoid accidental changes to the set point temperature of the bath.

To enable and disable the lock, press and hold the **set** and **up** or **down** keys for three seconds as shown below

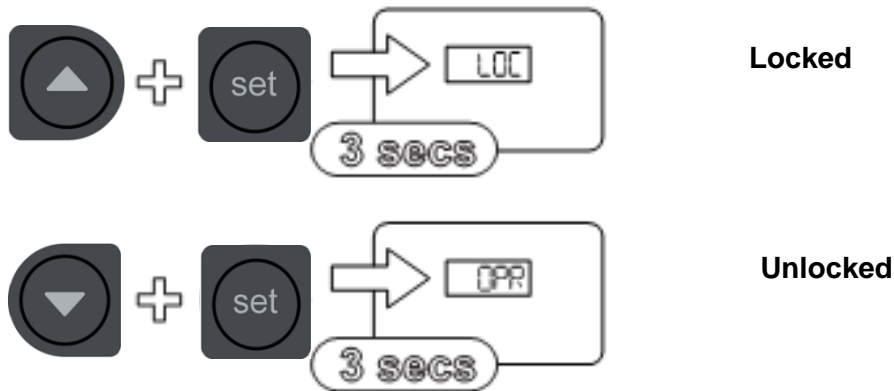

**Figure 5 - Locking and unlocking the keypad**



## 7.7 Setting the over temperature protection (OTP)

The over temperature protection can be used to protect samples by setting a maximum temperature limit the bath is allowed to heat to. If the bath exceeds this temperature, it will stop heating, display **OTP** (over temperature alarm) and sound an alarm.

The alarm can be silenced by pressing the **set** key.

Allow the bath to cool below the over temperature value to resume normal operation. Note that if the cause of overheating is an incorrect set point, this will need to be corrected otherwise the alarm will operate again.

You should set the over temperature value, allowing for a safety margin to the sample maximum temperature limit if possible. Additionally the **OTP** limit should be greater than the bath set point to avoid nuisance alarms. Grant recommends this is at least 1°C.

To set the over temperature alarm:

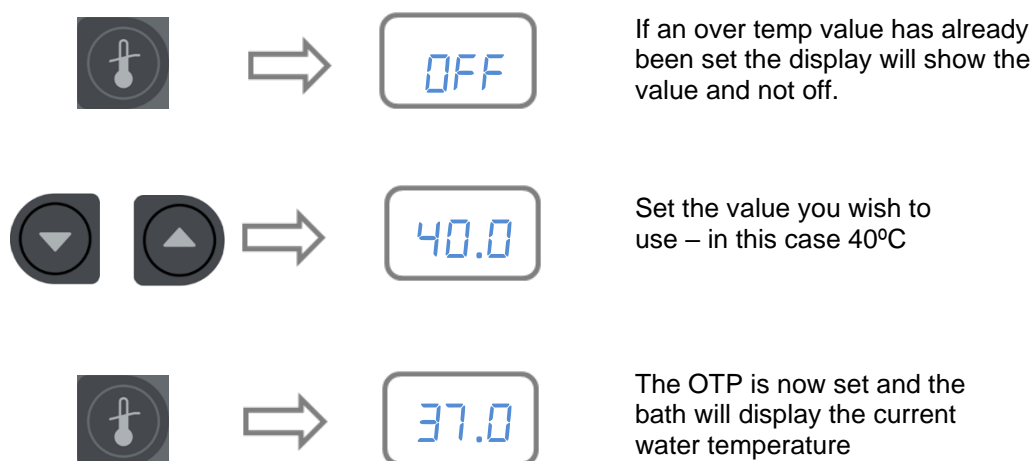

**Figure 6 - Setting the over temperature alarm**

To disable the alarm, set the over temperature alarm limit to 10.0°C and then press the down button one further time so the display shows **OFF**. Save this by pressing the over temperature alarm key.

## 7.8 Configuring and running temperature and shaking speed presets (Pr 1, Pr2)

Temperature and shaking speed presets allow you to conveniently store bath temperature and speed settings you routinely use. The bath has 2 presets, numbered Pr 1, Pr2.

Before you can use presets you need to store the values you wish to use in at least one of the presets using the following sequence:

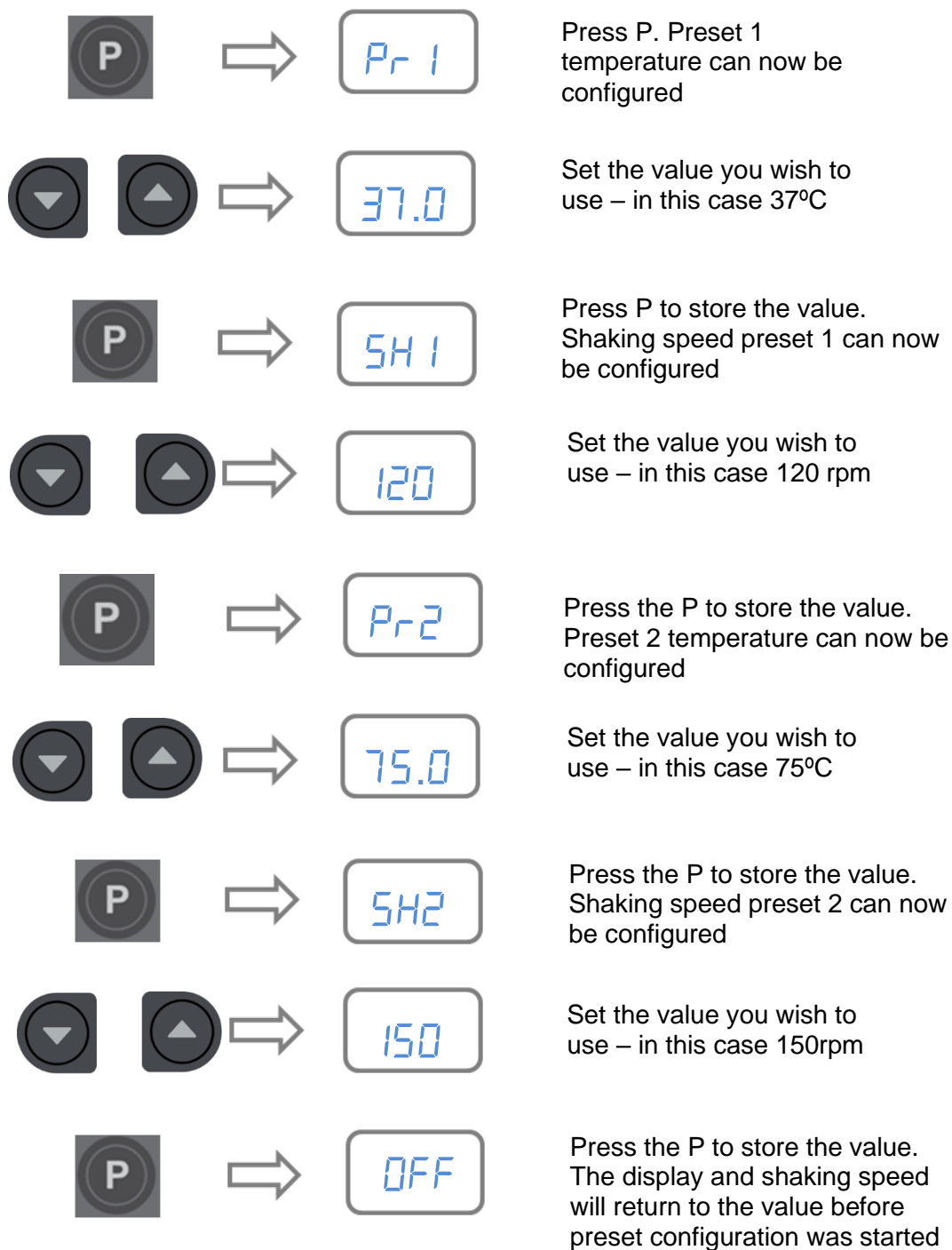

Figure 7 - Configuring a preset value

## 7.9 Running temperature presets (Pr 1, Pr 2)

### Running Preset 1



The Preset temperature is displayed momentarily before returning to the current bath temperature

### Running Preset 2



The Preset temperature is displayed momentarily before returning to the current bath temperature

Figure 8 – Running a preset

## 7.10 Setting the countdown timer (Cnt)

A countdown timer can be set in the range of 1 to 999 minutes. The countdown timer will sound an alarm at the end of a countdown period. It can be used to time experiments or remind you to take a further action.

Note the countdown timer does not take into account if the bath has not reached the set temperature. If the bath has not reached the set temperature, this will need to be taken into account when starting the countdown timer.

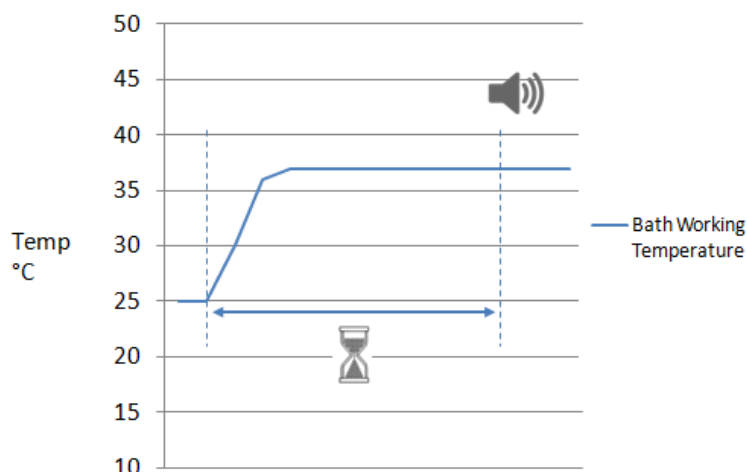

When the countdown timer expires the bath will sound an alarm and display *End*. Press **set** to silence the alarm.

To set the countdown timer:

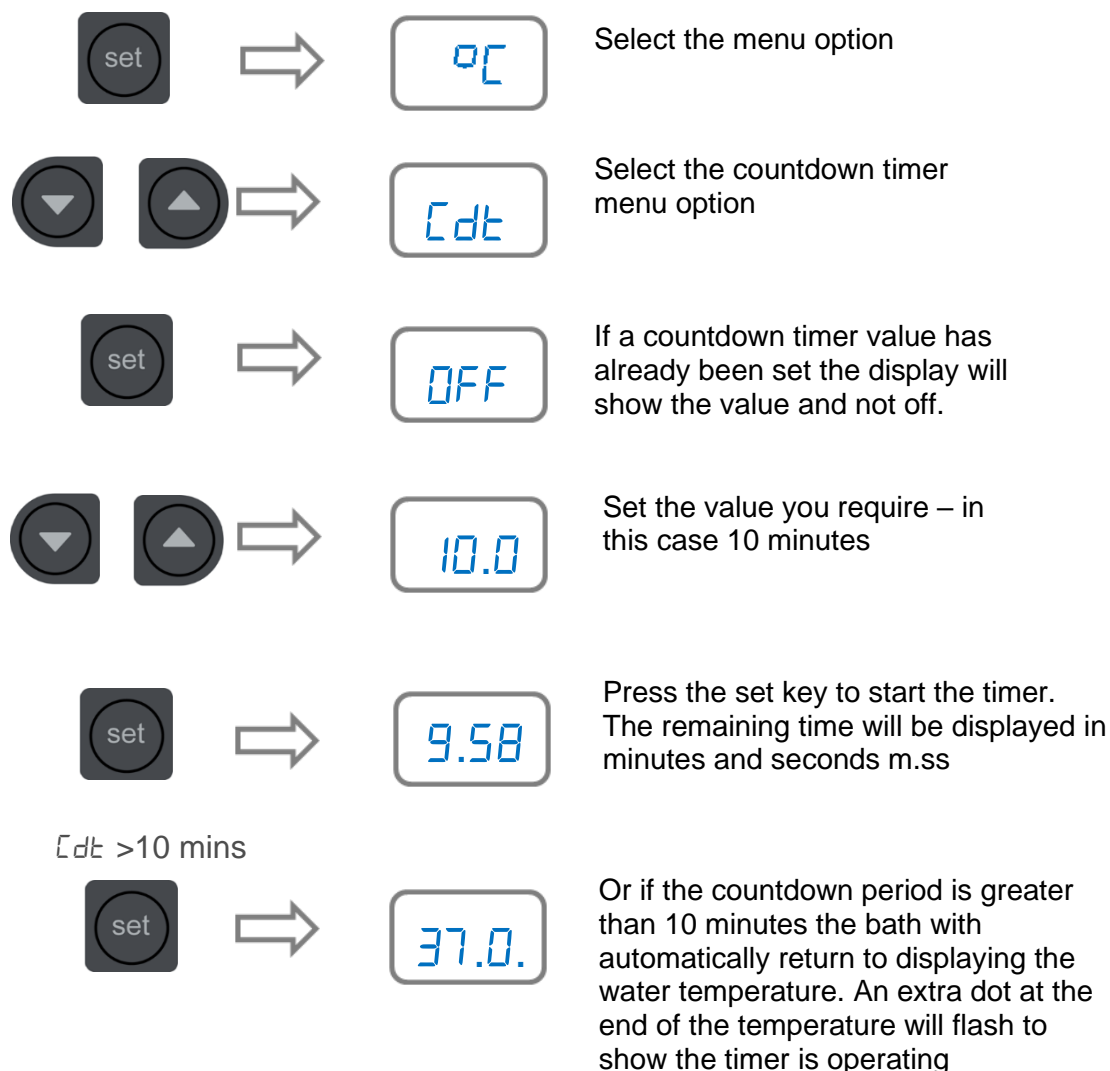

### Figure 9 - Setting the countdown timer

To find out the water temperature whilst the display is showing the remaining time, press the **set** button.

To enter the configuration menus whilst the display is showing the remaining time, press the **set** button twice.

The timer can be turned off at any time by selecting the *[dt* menu option and pressing the down arrow button until the display shows *OFF*.

## 8 Calibration

### 8.1 Calibration options

Two calibration options exist:

- Single point calibration
- Dual point calibration

	<p>The quality of the calibration is highly dependent on:</p> <p>Use of a suitable reference thermometer, ideally 10 times the accuracy you are trying to achieve.</p> <p>Performing a calibration in a stable ambient environment (<math>\pm 1^{\circ}\text{C}</math>) free from draughts or cooling air currents.</p>
---	---

### 8.2 Single point calibration (LPC)

A single point calibration applies a single offset over the bath temperature curve. For this reason the calibration temperature is usually the same as the intended working temperature for the bath or particular experiment:

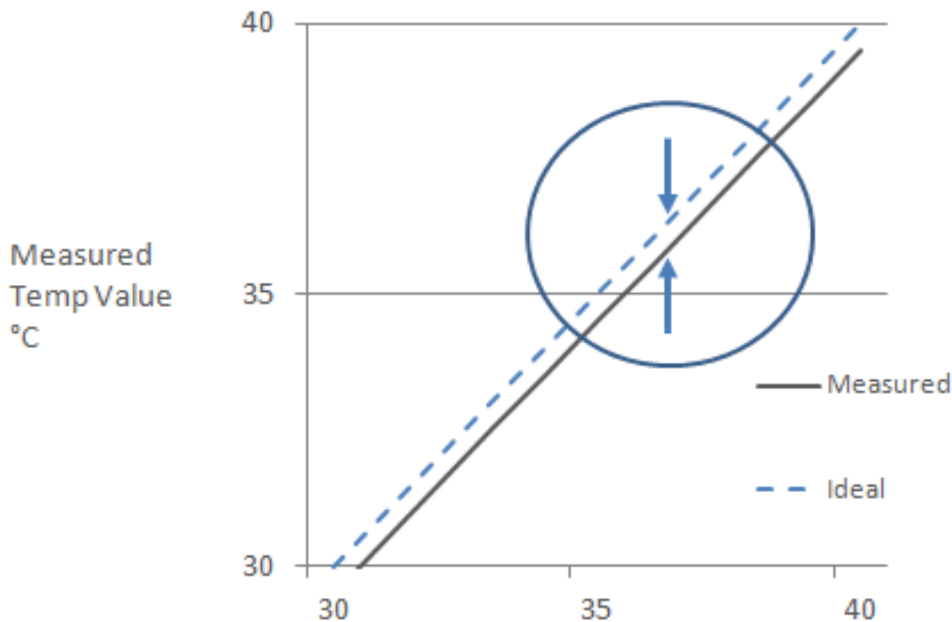

To configure a single point calibration:

Firstly, set the bath to the working temperature and shaking speed and leave to stabilise for at least an hour.

Place the reference thermometer either in the centre of the bath, or if using a lid, through the thermometer hole. Note the temperature shown by the reference thermometer and enter it into the calibration menu by following the steps below.

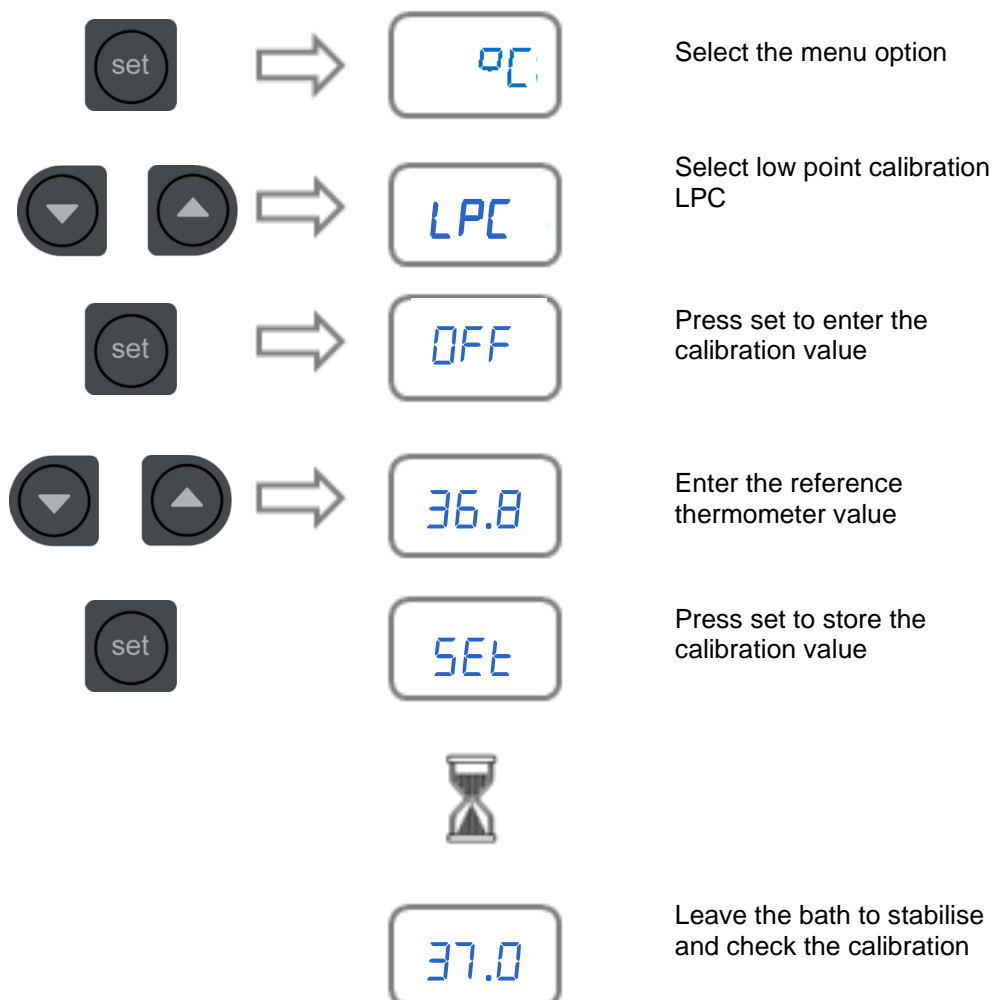
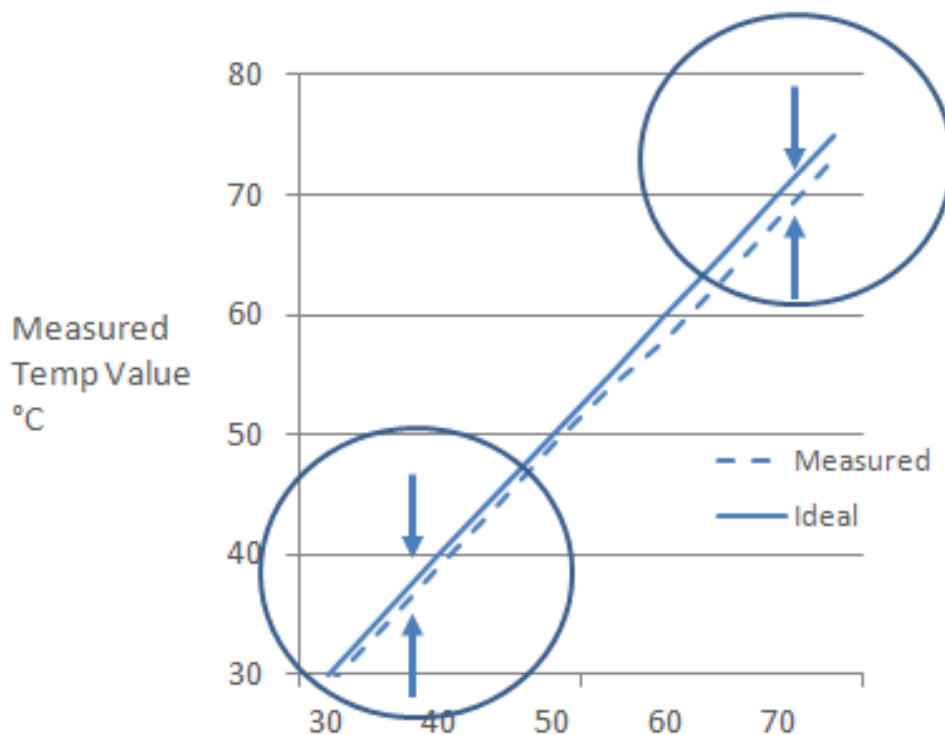

**Figure 10 - Setting a single point calibration**

### 8.3 Dual point calibration (LPC, HPC)

Dual point calibration is typically used on baths which are operated over a range of temperatures.

Two calibration points are entered into the calibration menu: the low calibration point (LPC) and high calibration point (HPC). These points are typically selected as just below and above the normal working temperature range for the bath.



Note that if only one calibration point is entered then the bath will behave as described in Single point calibration above.

To configure a dual point calibration, follow the steps below.

Firstly set the bath to the lower working temperature and shaking speed and allow to stabilise for at least an hour.

Place the reference thermometer either in the centre of the bath, or if using a lid, through the thermometer hole.

Note the value of the reference thermometer and enter it into the calibration menu by following the steps below.

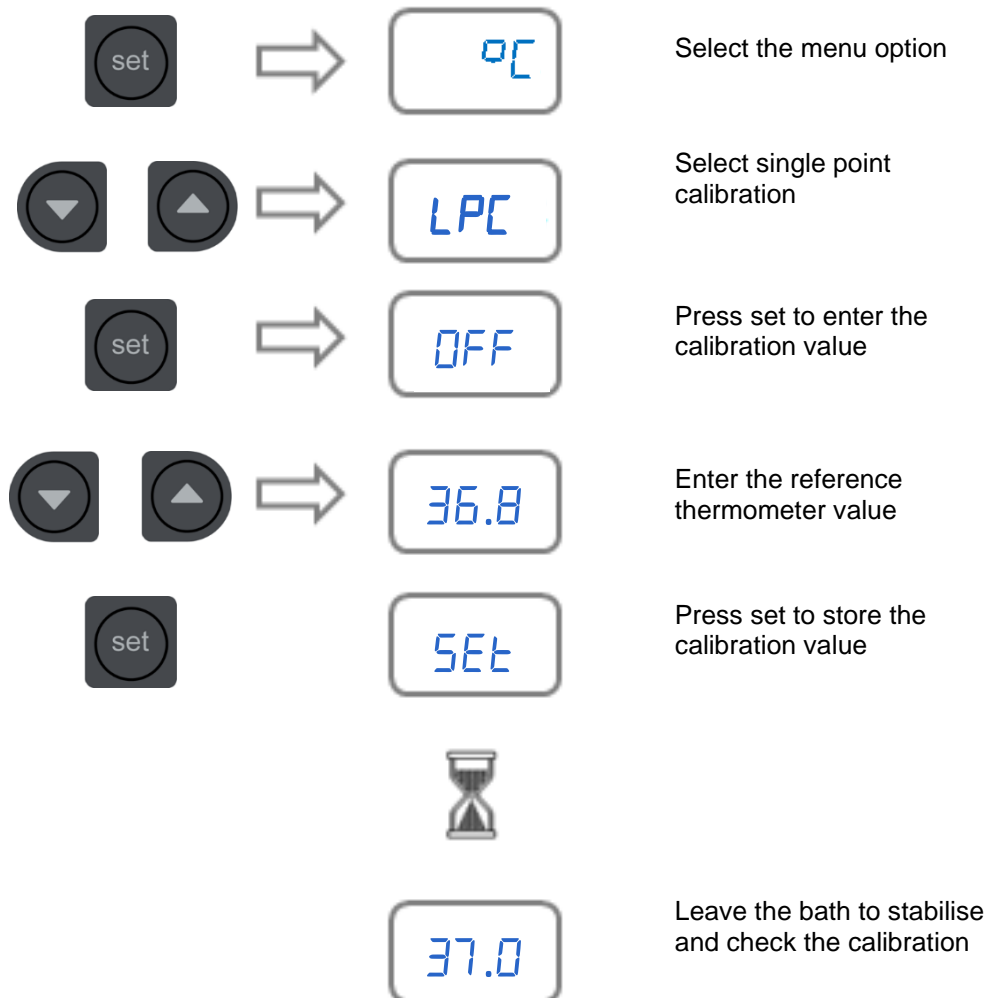

**Figure 11 - Setting the low point calibration**



Secondly set the bath to the upper working temperature and shaking speed and allow to stabilise for at least an hour.

Place the reference thermometer either in the centre of the bath, or if using a lid, through the thermometer hole.

Note the value of the reference thermometer and enter it into the calibration menu by following the steps below.

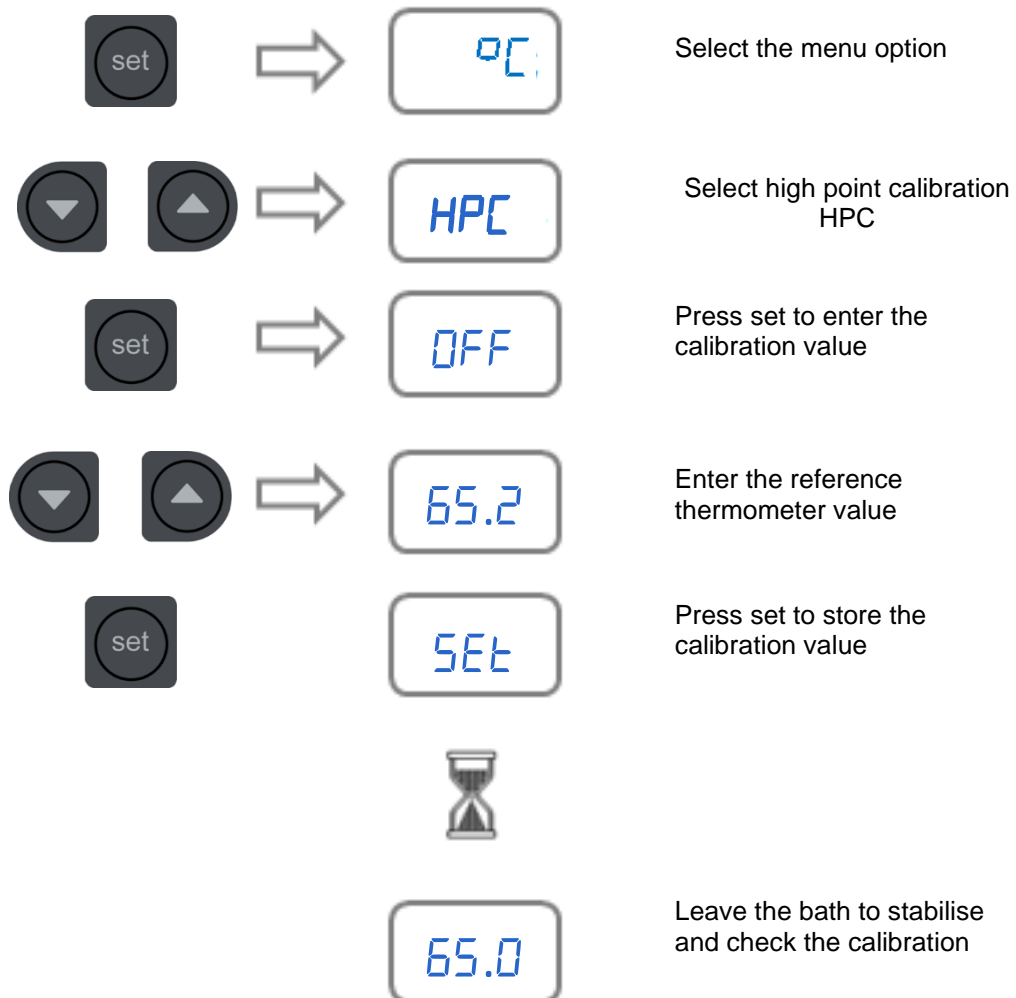

**Figure 12 - Setting the high point calibration**

## 9 Technical specification

---

### Operating conditions

Ambient Temperature	5 to 40°C
Maximum relative humidity	80% R.H. in room temperatures up to 31°C decreasing linearly to 50 % R.H. at 40°C
Altitude above sea level	Up to 5,000 m (16,400 ft)
Operating Environment	Indoor use only

### Electrical details

Mains supply: 220-240V @ 50/60 Hz or 110-120V @ 50/60 Hz

Pollution degree: 2

Installation Category: II

Note: Mains supply voltage fluctuations are not to exceed  $\pm 10\%$  of the nominal supply voltage

Models	Capacity (L)	Weight (kg)	Current rating (A)	
			120V	230V
LSB12	12	9.2	6.5	3.6
LSB18	18	11.2	9.0	6.2

### LSB Aqua Pro bath performance

Temperature range	5°C above ambient to 99°C
Display (also used for setting)	10.0 to 99.0°C in 0.1°C steps
Temperature stability	$\pm 0.1^\circ\text{C}$

All performance data specified tested in accordance with DIN12876.

### Storage and transport

Store and transport in original packaging. Temperature range -20°C to +60°C

## 10 Technical tips

---

### 10.1 Which water should you use in your bath?

- Use tap water with care. Water with a high lime content will cause scale build up and should be avoided.
- Distilled water and some types of de-ionised water may be used. Avoid ultra high purity de-ionised waters.
- Avoid using water with high levels of salts or iron. These will reduce the life of your bath
- Regular water changing and frequent cleaning of your bath is needed to preserve the baths corrosion resistance
- Ensure your bath is stored dry.
- Use care in placing other metallic items in the bath. Some metals (e.g. ferrous materials such as iron filings and swarf) can cause an electro-chemical reaction leading to corrosion.
- The product warranty may be affected by the use of inappropriate or corrosive liquids
- Refer to [www.grantinstruments.com](http://www.grantinstruments.com) for more additional information on corrosion prevention and cleaning guidance.

## 10.2 Troubleshooting guide

Sympton	Possible cause	Action
Unit does not operate	Unit not switched on  Unit not plugged into mains supply  Mains power supply failure	Turn on at switch at rear of unit Plug in and switch on  Check other appliances on the same circuit are working
Display shows $\square\text{E}A$	Overtemperature alarm has activated	Check OTA temperature is set above the Control temperature and the current liquid temperature. See section 7.7
Display shows $dr\text{Y}$	Bath is heating with insufficient liquid in the tank	Switch off the bath, fill the bath with liquid. See section 6.2 for recommed fill level. Power the bath on to resume operation
Display shows $\square\text{E}E$ and Alarm light on	Overtemperature cut-out has operated due to overheating	This cannot be reset by the user: have the unit checked by a competent person  Check the DPA is set to ON. See section 6.3
Trolley not shaking when speed shows OFF	Shaking speed has not been set	Set shaking speed. See section 7.4
Trolley not shaking when speed is not zero	Incorrectly fitted trolley  Speed is too high for load on trolley  Trolley is obstructed by limescale	Refit trolley  Reduce shaking speed or reduce load in the tray and retry  Clean trolley wheels and bath
Cannot set LPC or HPC	Other Cal point is already set within $5\text{C}^{\circ}$	Choose Cal point temperatures more than $5^{\circ}\text{C}$ apart and recalibrate

## 11 Warranty information

When used in laboratory conditions according to this manual, this product is guaranteed for THREE YEARS against faulty materials or workmanship.

Extended warranty for years four and five can be purchased by contacting our sales department at [salesdesk@grantinstruments.com](mailto:salesdesk@grantinstruments.com).

## 12 Maintenance and service

---

No routine maintenance is required except for cleaning. There are no user serviceable parts inside the unit.

### 12.1 Cleaning

Clean the outside of the equipment with a damp cloth. Domestic detergents may be used to remove stubborn dirt.

To ensure free running of the trolley keep the liquid and the bath clean and free from scale. From time to time remove the tray and trolley and the drive magnet. Clean the trolley wheels and the tank where the wheels run, with warm soapy water to remove all scale and grit. Also clean the magnet and its housing. Be careful not to damage the magnet.

Scale on immersed parts can also be removed using chemical de-scaling products designed for use on kitchen equipment that have metal parts. De-scaling products may be toxic and manufacturer's instructions should always be followed.

Before using any other cleaning or decontamination method, check with Grant Instruments or your local representative to make sure that the proposed method will not damage the equipment.

### 12.2 Fuses

The fuses are internal and should not need to be replaced.

### 12.3 Replacing the mains cord

Any replacement mains cord-set used with the water baths must meet the same specification as the one originally supplied with the unit to maintain safety of the unit and must be no more than 3m long.

For Europe (including the UK), the cable must have the following markings; <HAR>, HO5VV-F 3Gx1mm<sup>2</sup> and be rated to carry 10A. The mains plug and IEC connector must carry approvals from a European certification body (e.g. BSI, VDE or equivalent).

For Australia the cable must have the following markings; HO5VV-F 3Gx1mm<sup>2</sup> and be rated to carry 10A. The mains plug, lead and IEC connector must carry approvals from an Australian regional authority (e.g. N, NSW or equivalent).

For North America

- 12 litre unit: the cable must have the following markings; SVT, 3x 18AWG, VW-1, 75°C, 300V, FT2 and be rated to carry 10A. The mains plug, lead and IEC connector must carry 3<sup>rd</sup> party approval marks for Canada and the US (e.g. CSA and UL marks/file numbers).
- 18 litre unit: the cable can only be replaced by Grant. Please contact Grant for our North American service agent's contact details.

### 12.4 Routine safety tests

If routine tests are to be made, we recommend a test of the integrity of the protective earth conductor and an insulation test at 500 V DC. Routine flash tests are not recommended for any electrical equipment, because repeated high voltage tests degrade insulation materials.

## 12.5 Service

If service is required, switch off the unit and contact Grant Instruments or your local representative for repairs.

Service Department  
Grant Instruments (Cambridge) Ltd  
Shepreth  
Cambridgeshire  
SG8 6GB  
UK

Tel: +44 (0) 1763 260 811  
Fax: +44 (0) 1763 262 410  
E-mail: [labservice@grantinstruments.com](mailto:labservice@grantinstruments.com)

## 13 Compliance

---

The equipment covered by this manual complies with the following EU Directives:

- EMC Directive 2014/30/EU
- LVD Directive 2014/35/EU
- RoHS Directive 2011/65/EU

Compliance has been verified by the application of the following standards:

- BS EN 61326-1 Electrical Equipment for measurement, control and laboratory use - EMC requirements- Part 1: General requirements
- BS EN61010 Part 1 Safety requirements for electrical equipment for measurement, control and laboratory use
- BS EN61010 Part 2-010 Safety requirements for electrical equipment for measurement, control and laboratory use. Particular requirements for laboratory equipment for the heating of material
- BS EN61010 Part 2-51 Safety requirements for electrical equipment for measurement, control and laboratory use. Particular requirements for laboratory equipment for mixing and stirring
- BS EN50581 Technical documentation for the assessment of electrical and electronic products with respect to the restriction of hazardous substances

Additionally for 110-120V versions only:

- The equipment is  marked to show compliance with North American Safety Standards.
- This device complies with Part 15 of the FCC rules. Operation is subject to the following two conditions: (1) this device may not cause harmful interference, and (2) this device must accept any interference received, including interference that may cause undesired operation.

## **WEEE Directive**

In Europe, at the end of its life the block heater must be disposed of in accordance with the WEEE directive, For information regarding WEEE collections in the UK please contact our B2B Compliance Scheme directly on 01691 676 124

Grant Instruments complies fully with the Waste Electrical & Electronic Equipment (WEEE) regulations 2013. We are a member of the B2B compliance scheme (Scheme Approval Number WEE/MP3338PT/SCH), which handle our WEEE obligations on our behalf. Grant Instruments have been issued with a unique registration number by the Environmental Agency, this reference number is WEE/GA0048TZ.

For other countries please contact your equipment supplier.

For General WEEE information please visit: [www.b2bcompliance.org.uk](http://www.b2bcompliance.org.uk)

## **RoHS Directive**

All the products covered by this manual comply with the requirements of the RoHS Directive (Directive 2011/65/EC including 2015/863). This means the products are free of Lead and other hazardous substances covered by the directive.

## **Electrical safety and Electromagnetic compatibility**

All the products covered by this manual comply with the requirements of the Low Voltage Directive (2014/35/EC) for Electrical safety and the EMC directive (2014/30/EC) for Electromagnetic compatibility.

## **REACH Regulations**

This product does not contain any substances very hazardous to health (SVHCs) at greater than 0.1% that have to be identified in accordance with Regulation (EC) No 1907/2006 and therefore does not have an entry in the SCIP database.



**Grant Instruments (Cambridge) Ltd**  
Shepreth  
Cambridgeshire  
SG8 6GB  
UK

Tel: +44 (0) 1763 260811  
Fax: +44 (0) 1763 262410  
Email: [salesdesk@grantinstruments.com](mailto:salesdesk@grantinstruments.com)  
Web: [www.grantinstruments.com](http://www.grantinstruments.com)

32138 V4 /DMN T44 /Oct 2021

**Grant Instruments Europe B.V.**  
Strawinskylaan 411  
WTC, Tower A, 4th Floor  
1077 XX, Amsterdam  
The Netherlands

Email: [grant@eu.grantinstruments.com](mailto:grant@eu.grantinstruments.com)