

This manual contains information on the CKG16, set of calibration standards, procedures for calibration and safety data sheets (SDS).

If you have any feedback on our products or services, we would like to hear from you. Please send all feedback to:

Biosan SIA

Ratsupites 7 k-2, Riga, LV-1067, Latvia

Phone: +371 674 261 37, fax: +371 674 281 01

<https://biosan.lv>

Marketing: marketing@biosan.lv

Service: service@biosan.lv

Table of contents

1. About the standard ⇨
2. Calibration procedure ⇨
3. Safety Data Sheet ⇨

1. About the standard

1.1. **Intended use.** McFarland Latex Standards are used as turbidity standards for adjusting densities of bacterial suspensions.

1.2. **Summary.** McFarland Standards provide a reference for standardization of bacterial suspensions used for susceptibility testing and other procedures that require a standardized inoculum. Original McFarland Standards were prepared by adding barium chloride to sulfuric acid resulting in a barium sulfate precipitation. CLSI now accepts the use of latex particle suspension turbidity standards for the preparation of standardized bacterial suspensions. (Clinical and Laboratory Standards Institute (CLSI - formerly NCCLS). Performance Standards for Antimicrobial Disk Susceptibility Tests, 10th ed., M02-03, Section 8.1. CLSI, Wayne, PA.)

The McFarland Latex Standards are prepared from suspensions of uniform latex particles with similar absorbance values as the original barium sulfate standards. The latex standards are prepared by suspending latex particles in a buffer solution. Sodium azide is added as a preservative. The standards are adjusted to an acceptable absorbance range with a one centimeter light path set at 625nm. Adjusting the bacterial suspension turbidity to a McFarland Standard produces bacterial counts in an expected range. As with the barium sulfate standards, a 0.5 McFarland Latex Standard is comparable to a bacterial suspension of 1.5×10^8 CFU/ml. The stability of McFarland Latex Standards allows for a significantly longer shelf-life than the original barium sulfate standards due to reduced light sensitivity.

1.3. **Storage.** Upon receipt store at 2-30°C. These products are ready for use and no further preparation is necessary. These products should be stored in their original container. Do not freeze or overheat. Do not incubate prior to use. Standards should not be used if there are any signs of deterioration, contamination or color change or if the expiration date has passed.

The expiration dating on the product label applies to the product in its intact packaging when stored as directed. The product may be used and tested up to the expiration date on the product label and incubated for the recommended quality control incubation times.

1.4. **Risks and Safety.** Please observe the necessary precautions for use of laboratory reagents and body fluids; as well as possibly also of microbiological samples. Applications should be performed by expert personnel only. Follow the national and laboratory internal guidelines for work safety and infection control. Wear suitable protective clothing and disposable gloves while handling. It is important to ensure effective protection against infection according to laboratory guidelines.

1.4.1. For additional safety information please refer to the information on the label and the corresponding Safety Data Sheet (SDS) further below.

1.5. **Limitations.**

 Do not mix latex standards with a mechanical mixer or vortex.

1.6. **Support and information service.** For methodological and technical support or to receive a copy of certificate of analysis please contact us by email at service@biosan.lv. Periodically check for updates of this product information on our website.

1.7. **Waste Management.** Please observe your national laws and regulations.

2. Calibration procedure

2.1. **Before using the standards.** Invert the tubes carefully several times to assure uniformity of the suspension of the latex particles.

2.2. **About calibration of the DEN-1 / DEN-1B.** The device is precalibrated at the factory for operation with the glass tubes 16 mm in external diameter (see label on the bottom side of the unit) at temperatures from +15°C to +25°C and saves calibration data when switched off.

 Recalibrate the unit before using other type of tubes (e.g. with different outer diameter, bottom shape or material such as plastic).

2.3. Perform calibration from lower to higher calibration value. Use at least 2 points for calibration. Available calibration standards: 0.5, 1.0, 2.0, 3.0 and 4.0.

2.4. Connect the external power supply to electric circuit. Switch on the unit using the **Power** switch (fig. 1/1) on the rear panel.

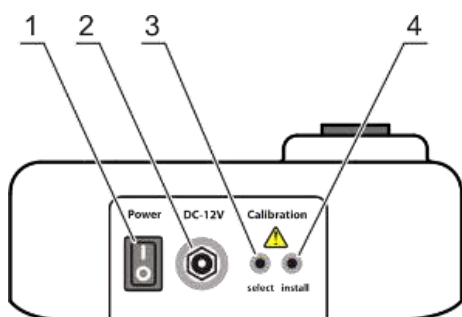

Figure 1. Rear panel of DEN-1/DEN-1B unit

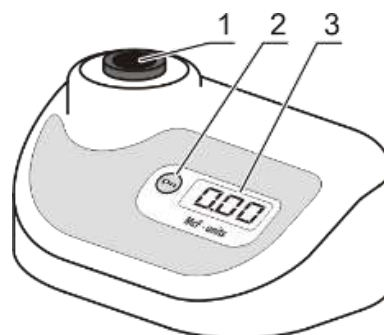





Figure 2. Front view

 Note: **DEN-1B** can operate without external power supply on battery power.

 Attention! Make sure that the tube socket is empty. For Ø12 mm or Ø16 mm tubes, place the **A-12** or **A-16** adapters, accordingly.

2.5. Press the **Select** button (fig. 1/3) on the rear of the unit.

 Note: Use a thin pin (max. Ø2 mm) for pressing the **Select** and **Install** buttons.

2.6. Set the values for an empty socket -.- and transparent standard 0.00.

2.6.1. Empty socket. Display shows -.- indication. Press **Install** button (fig. 1/4) to save empty socket value. Display shows next required calibration value.

2.6.2. Transparent standard. Display shows 0.00. Insert standard for 0.00 value into the socket (fig. 2/1) of the unit. If the standard for 0.00 value is not available, fill the tube (of the kind that is used for operations) with distilled water. Use the tube as the 0.00 value standard. Press **Install** button to save empty socket value. Display shows next required calibration value.

 Note: Calibrate the unit using as many points as possible to obtain precise results. Minimum requirement are 2 points closest to the working range limits (e.g. 0.00 and 4.00 for operation in 0.00–4.00 McF range).

2.7. Common calibration rules. Display shows indication of necessary calibration value. Insert the necessary standard into the socket (fig. 2/1) of the unit and press the **Install** button to save the value for current standard.

 Note: If pressing the **Install** button does not switch to the next standard value, it means that the current standard in the socket has lower turbidity value than the previous standard. Shake or replace the standard.

2.8. If a standard is not available, press the **Select** button to skip to the next calibration value without recording the value.

2.9. Repeat steps 2.7–2.8 until the calibration is complete. After recording or skipping the last value, unit automatically exits calibration mode and is ready for operation.

2.10. **Reset to factory calibration.** To reset the calibration of the unit to factory settings, ensure that you are in the working mode and the socket of the unit is empty. Press and hold **Install** key for 5 s. The unit displays a dot . , then changes it to 0.00. The values are reset.

2.11. Switch off the unit using the **Power** switch (position **O**). If an external power supply is used, disconnect it from electric circuit.

3. Safety Data Sheet

Hardy Diagnostics

Safety Data Sheet



1. Product And Company Identification

1.1. Product identifiers

Product Name:	McFarland Latex Standard #0.5	McFarland Latex Standard #1	McFarland Latex Standard #2	McFarland Latex Standard #3	McFarland Latex Standard #4
Catalog Number:	ML05	ML1	ML2	ML3	ML4

Other Common Names: None.

1.2. Recommended use

McFarland Latex Standards are used as turbidity standards for adjusting densities of bacterial suspensions.

1.3. Details of the supplier of this Safety Data Sheet

Company: Hardy Diagnostics 1430 West McCoy Lane Santa Maria, CA 93455
Telephone: (805) 346-2766; (800) 266-2222
Emergency Phone: (800) 424-9300 ChemTrec (24hr service)

2. Hazards Identification

2.1. Classification of substance or mixture

Not a hazardous substance or mixture.

2.2. GHS Label elements, including precautionary statements

Not a hazardous substance or mixture.

2.3. Hazards not otherwise classified or not covered by GHS

Not a hazardous substance or mixture.

3. Composition/Information on Ingredients

3.1. Mixtures: Synonym: None

No ingredients are hazardous according to OSHA criteria.

No components need to be disclosed according to the applicable regulations

4. First Aid Measures

4.1. Description of general first aid measures:

Inhalation:	If inhaled, remove to fresh air. If not breathing, give artificial respiration and immediately seek medical attention.
Ingestion:	Do not induce vomiting unless directed to do so by medical personnel. Never give anything by mouth to an unconscious person. Seek medical advice.
Skin Contact:	Immediately wash thoroughly with soap and water. If irritation persists, consult a physician. Avoid touching contaminated clothing.
Eye Contact:	Check for and remove any contact lenses. Immediately flush eyes with plenty of water for at least 15 minutes, keeping eyelids open. If irritation persists, consult a physician.

4.2. Most important symptoms and effects, both acute and delayed

No data available

4.3. Indication of any immediate medical attention and special treatment needed

No data available.

5. **Firefighting Measures**

5.1. Extinguishing media

Water spray, carbon dioxide, dry chemical powder, or appropriate foam.

5.2. Special hazards arising from the substance or mixture

No data available.

5.3. Advice for firefighters

In the event of a fire, wear protective clothing and NIOSH-approved breathing apparatus necessary to prevent any possible irritation.

5.4. Further information

No data available.

6. **Accidental Release Measures**

6.1. Personal precautions, protective equipment and emergency procedures

Wear protective equipment: chemical resistant gloves. Keep unprotected persons away.

6.2. Environmental precautions

No data available.

6.3. Methods and materials for containment and cleaning up

Wipe up with a damp sponge or mop.

6.4. Reference to other sections

For disposal, see section 13.

7. **Handling and Storage**

7.1. Precautions for safe handling

Wear appropriate personal protective equipment.

7.2. Conditions for safe storage, including any incompatibilities

Keep container tightly closed. Store in a cool, dry place in accordance with specified storage conditions.

7.3. Specific end uses

Apart from uses mentioned in section 1.2, no other specific uses are stipulated.

8. **Exposure Controls/Personal Protection**

8.1. Control parameters

No data available.

8.2. Appropriate engineering controls

Safety shower and eye bath.

8.3. Personal protective equipment

Eye/Face:	Safety goggles, as needed
Skin:	Chemical resistant gloves, as needed
Respiratory:	None for normal use
Thermal Hazards:	None for normal use

9. **Physical and Chemical Properties**

9.1. Information on basic physical and chemical properties

Appearance:	Physical State: liquid Color: white with blue
Odor:	Not Determined
Odor Threshold:	Not Determined
pH:	Not Determined
Melting/Freezing Point:	Not Determined
Boiling Point:	Not Determined

Flash Point:	Not Determined
Evaporation Rate:	Not Determined
Flammability:	Not Determined
Explosion Limits:	Not Determined
Vapor Pressure:	Not Determined
Vapor Density:	Not Determined
Relative Density:	Not Determined
Water Solubility:	Soluble
Partition coefficient (n-octanol/H₂O):	Not Determined
Auto-ignition Temperature:	Not Determined
Decomposition Temperature:	Not Determined
Viscosity:	Not Determined
Explosive Properties:	Not Determined
Oxidizing Properties:	Not Determined

9.2. Other safety information

No data available.

10. Stability and Reactivity

Reactivity	No data available.
Chemical stability	This product is stable.
Possibility of hazardous reactions	No data available.
Conditions to avoid	No data available.
Incompatible materials	No data available.
Hazardous decomposition products	No dangerous decomposition products known.

11. Toxicological Information

11.1. Information on toxicological effects

Acute toxicity	No data available
Skin corrosion/irritation	No data available
Serious eye damage/eye irritation	No data available
Respiratory or skin sensitization	No data available
Germ cell mutagenicity	No data available
Carcinogenicity	No data available
Reproductive toxicity	No data available
Specific target organ toxicity – single exposure	No data available
Specific target organ toxicity – repeated exposure	No data available
Aspiration Hazard	No data available
Additional information	No data available

12. Ecological Information

Toxicity	No data available
Persistence and degradability	No data available
Bioaccumulative potential	No data available
Mobility in soil	No data available
Results of PBT and vPvB assessment	No data available
Other adverse effects	No data available

13. Disposal Considerations

13.1. Waste disposal

Dispose of in accordance with applicable state and federal regulations. Disposal must be in accordance with regulations 40 CFR 261.

14. Transport Information

DOT hazard class	None
Shipping name	None
Identification number	None
Packing group	None

15. Regulations

Carcinogenicity	Yes/No
NTP:	No
IARC:	No
OSHA:	No
California Prop 65:	No
IATA:	No

16. Other Information

The above information, to the best of our knowledge, is accurate. Hardy Diagnostics assumes no liability whatsoever for the accuracy or completeness of the information stated above. Final determination of suitability of any material is the sole responsibility of the user. All materials may present unknown hazards and should be used with caution. Although certain hazards may be described, we cannot guarantee that these are the only hazards that exist.

Revision Date: 12/21/18

HARDY DIAGNOSTICS

1430 West McCoy Lane, Santa Maria, CA 93455, USA

Phone: (805) 346-2766 ext. 5658

Fax: (805) 346-2760

Website: www.HardyDiagnostics.com Email: TechService@HardyDiagnostics.com

Distribution Centers:

California · Washington · Utah · Arizona · Texas · Ohio · New York · Florida · North Carolina