



LAMY
RHEOLOGY
INSTRUMENTS

USING MANUAL

RM 100i

VERSION N° RM100i-UK05/2023



TABLE OF CONTENTS

1	INTRODUCTION	4
1.1	Components	5
1.2	General view of your device	6
1.3	Connexions	8
1.4	Specifications	8
1.5	Installation	9
2	GETTING STARTED	10
2.1	State icons	10
2.2	Main Menu	11
2.3	Measure menu	11
2.3.1	Manual measure mode	12
2.3.2	Automatic measure mode	14
2.4	View results menu	17
2.4.1	Show results	17
2.4.2	Export results	18
2.4.3	Delete results	19
2.5	Zero setting	19
2.6	Parameters menu	20
2.6.1	Languages	21
2.6.2	Date / Hour	21
2.6.3	Sounds/Standby/Lighting	22
2.6.4	User Name	22
2.6.5	Units/Density	24
2.6.6	Measuring System	24
2.6.7	Locked Mode	27
2.6.8	Torque range	28
2.6.9	Miscellaneous	28
2.6.10	LIMS mode	29
2.6.11	Printing	29
2.6.12	Service	30
2.7	Remote mode menu	30
2.8	Programs menu	30
2.8.1	Create new program	31
2.8.2	Edit program	35
2.8.3	Delete program	35
2.9	Temperature setpoint menu	35
3	MEASURING WITH YOUR DEVICE	36
3.1	Installation of measuring system	36
3.2	MS RV/LV (GuardLeg)	36
3.3	MS BV	39
3.4	MS VANE	40
3.5	MS KREBS	42
3.6	MS DIN	43
3.6.1	Use of category A (MS-DIN)	44
3.6.2	Use of category B (MS-DIN" S")	47

3.7 MS SV (Thermocell and Small Volume Package)	49
3.7.1 MS-SV with Chamber MB-SVD (Thermocell)	50
3.7.2 MS-SV with chamber MB-SV13R (Thermocell and SVP65/180)	52
3.7.3 MS-SV with chamber MB-SV13RC	54
3.8 T-Bars and Helipro Stand.....	55
3.9 MS-R	57
3.9.1 MS-R without temperature control.....	58
3.9.2 Utilisation with temperature control	60
4 VERIFICATION OF YOUR DEVICE	62

1 INTRODUCTION

Normally, the Viscometer RM100i should be used on production area to monitoring viscosity reading of sample.

When RM100i is used on production area, installation of device is under responsibility of end user and this manual cannot cover each special configuration.

This user manual cover use of electronic box and different function of device. As it can be also used as laboratory device when it is ordered with stand and measuring system as shown below, part of this manual as section 1.2, 1.3 and 3 concern use of RM100i as laboratory device.

The instrument is a device able to measure the viscosity, which is capacity of a product to resist to the flow.

The fluid is forced to a shear rate (rotational speed) and the shear stress (motor torque) is measured. The values of shear rate and shear stress then make it possible to calculate the viscosity using the Newton equation and the constants associated with the mobile used.

$$\text{Equation of Newton is: } \eta = \frac{\tau}{\dot{\gamma}}$$

With η for viscosity in Pa.s, τ for shear stress in Pa and $\dot{\gamma}$ for shear rate in s^{-1} .

Shear stress and shear rate are calculated by using constants of each measuring system as:

$$\tau = M \times K_{\tau} \text{ with } M \text{ for motor torque in mNm and } K_{\tau} \text{ in Pa/mNm.}$$

$$\dot{\gamma} = n \times K_D \text{ with } n \text{ for rotational speed in rpm and } K_D \text{ in } s^{-1}/\text{rpm.}$$

The instrument calculates the viscosity by dividing the shear stress by the shear rate for each measuring point. The K_{τ} and K_D constants used depend on the measuring system selected for the measurement.

Viscosity depends on the temperature, then it must be essential that all viscosity values are associated to a reading of the sample temperature, in order to compare viscosity for different samples.

There are some products for which the viscosity, to a constant temperature, stay unchanged, even if we change the shear rate. Those samples are named **Newtonian fluids**, i.e. : Oils, Water, Glycerol, etc...However, many substances have a variation of viscosity in function of speed of shearing, and the Flow Behaviour of those samples could be determined with measuring instruments able to set many speeds of rotation.

The instrument is constituted with a continuous current motor with an optical encoder, in order to warranty a great accuracy of the speed of rotation of bob, on all torque range.

The instrument has an easy touch screen display, on which you could read the **speed, measuring spindle** reference, temperature, the measured torque and the dynamic **viscosity in mPa.s (=cPoises) or Pa.s**.

The instrument can be used with different measuring system. You will find below a list of compatible measuring system with this instrument.

- **MS RV/LV:** Measuring spindles according to ASTM / ISO 2555 (316L stainless steel). These systems are ideally suited for simple viscosity measurement at controlled rotational speed in all areas of activity. The standard recommends use of 600ml beaker for measurement.

- **MS BV:** Measuring spindle for 150ml beaker (316L stainless steel). These spindles are ideally suited for simple viscosity measurement at a rotating speed in control in all areas of activity. They are appreciated for their ease of use and the low volume of product needed compared to the MS ASTM spindles.

- **MS VANE:** Measuring spindles with blades (316L stainless steel). These systems are ideal for viscosity measurement (value or curve) in control or development of all types of products even of very high viscosity with or without particles (size <5mm). They can be used for direct measurement in user's containers or in tubes of MS-DIN systems.

- **MS KREBS:** Krebs type measuring spindles compatible with ASTM D562 standard (316L stainless steel). These systems are ideal for viscosity measurement in Krebs units in control of all types of products. They can be used for direct measurement in user containers or in 600 or 150ml beakers.
- **MS DIN:** Coaxial cylinders measuring systems according to DIN / ISO 3219 (316L stainless steel). These systems make it possible to set the shear rate in order to carry out viscosity measurements or to obtain curves to study flow behaviour, yield stress or thixotropy. They are particularly suitable for the control or development of homogeneous products with liquid aspect and with or without particles (size <math><200\mu\text{m}</math>).
- **MS SV:** Measuring systems for low volumes (316L stainless steel). These systems, unlike the MS-ASTM and MS-DIN systems, make it possible to measure products in small quantities by applying a shear rate up to temperatures of 200 ° C (according to models, see table). With RT1, these systems are compatible with ASTM D3236 or D4402.
- **T-BARS:** Special spindle (316L stainless steel) used with HELIPRO stand. These spindles allow while move up/down of lift to avoid cavity formation. They are highly recommended with non-flowing materials.
- **MS-R:** Anchor-type measuring systems (316L stainless steel). These systems are ideally suited for measuring viscosity (value or curve) in the control or development of heterogeneous products, or having the appearance of soft solid at rest, present in cosmetics, paint, food or mineral chemistry industries. Used with their respective cups, they allow to apply a shear rate.

1.1 Components

Instrument is delivered inside a foam protection to avoid any problem during transport. According to your order this foam can be inside a box or a carrying case and can contain measuring system.

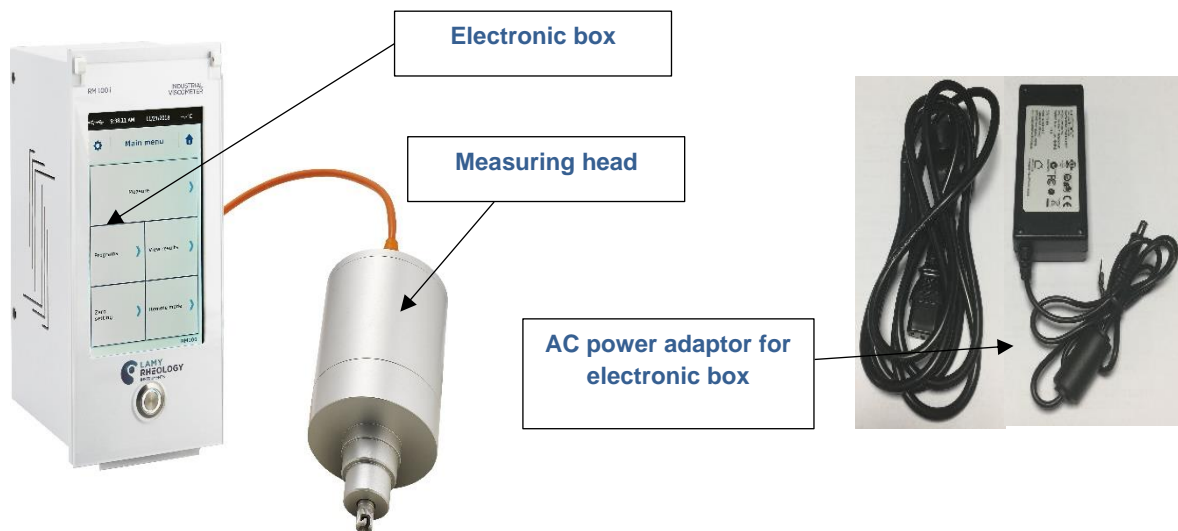

When device is ordered with stand (standard or rack stand), you will find different part in your box as shown below.

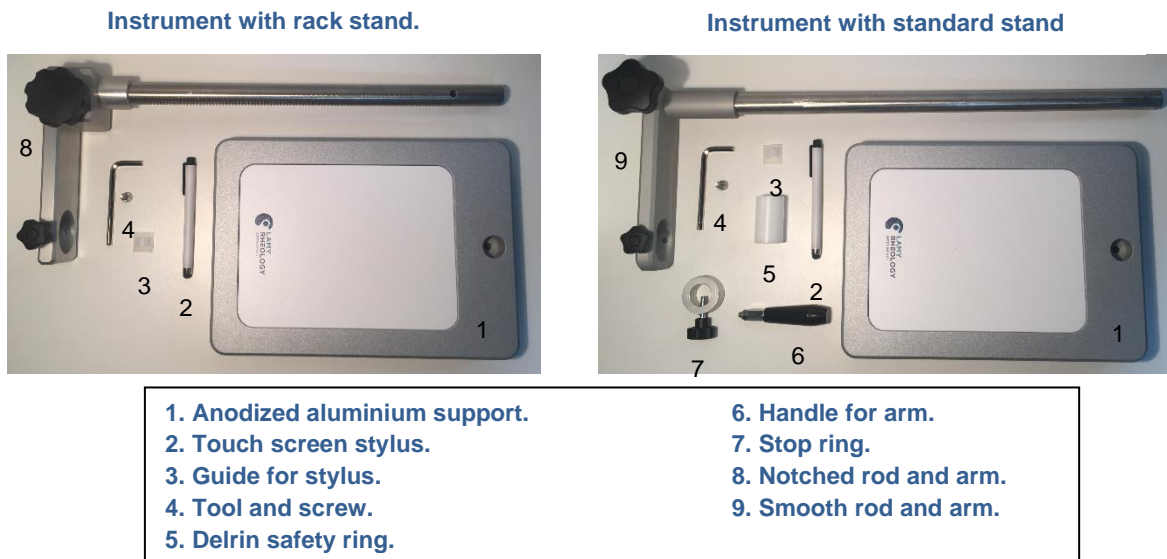

1.2 General view of your device

Once your device will be mounted and installed, it looks like this;

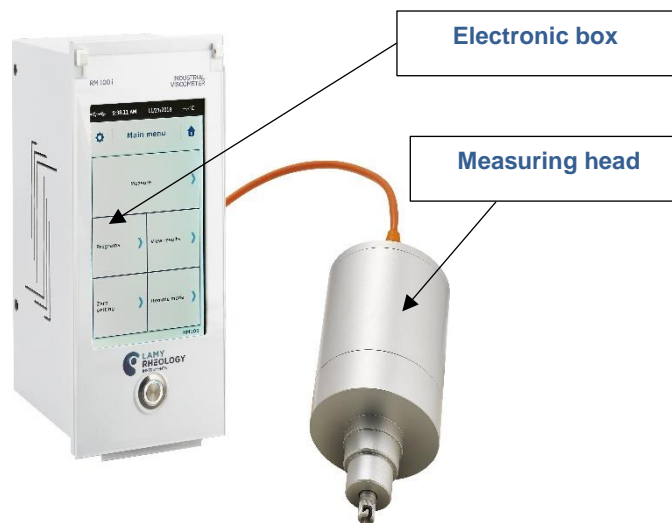

- **TOUCH Screen**

The new PLUS series is equipped with a 7" colour touch screen. It gives you greater working comfort and a clearer view of your data and analysis results.

- **Electronic box**

Shape and connection of this box allow easy installation inside customer installation. This box could be proposed without housing or with specific protection (water proof). A cover protect the screen against projection.

- **On / Off Switch**

Always with the aim of improving your experience, LAMY RHEOLOGY has decided to equip all of its PLUS range with a luminous and design switch. It has been placed in the centre of the device for greater intuitiveness.

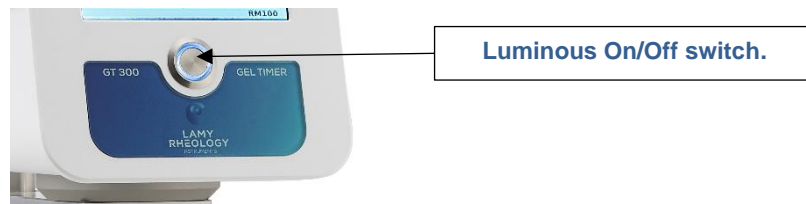

- **Aluminium arm (if ordered with stand)**

The aluminium arm of the standard stand has tightening knob that allows you to maintain the height of the measuring head and handle for easy handling.

The aluminium arm of the rack support is fitted with a button for raising or lowering the measuring head.

The measuring head is attached to arm using a screw fitted with a tightening knob.

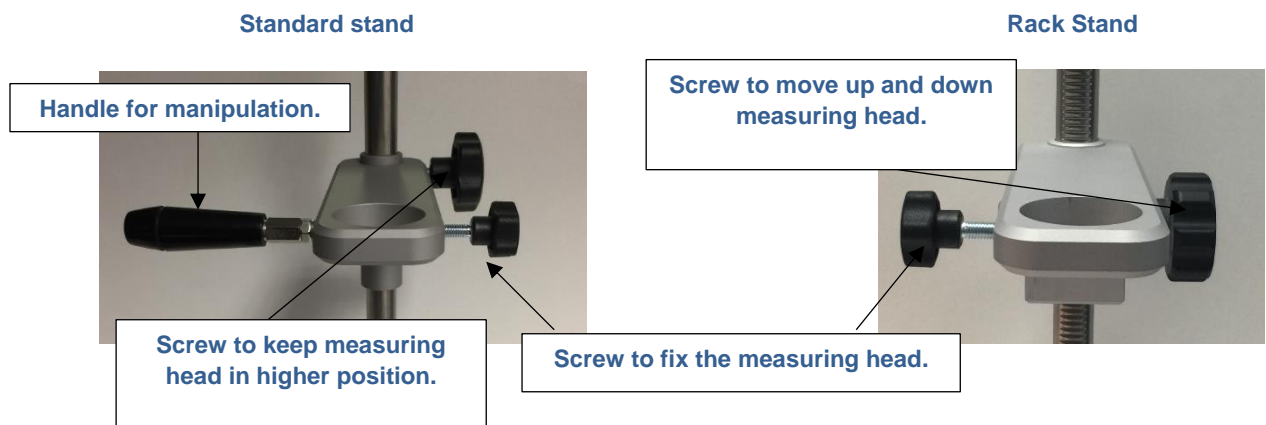

- **Stainless steel rod (if ordered with stand)**

The rod of supports is made of stainless steel for a solid hold on the measuring head. They have a very long lifespan. The standard support is fitted with a Delrin safety ring preventing the measuring head from touching the support. It is also equipped with a stop ring for memorizing a measurement height.

These two rings are not present on the rack support.

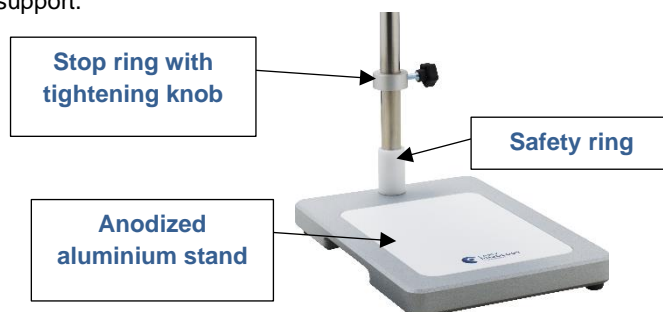

- **Anodized aluminium support (if ordered with stand)**

The stand is entirely made of anodized aluminum. It gives our instruments an unmatched stability (the maximum permissible temperature on the white part is 50 ° C).

1.3 Connexions

According to your order, rear panel of device get these available connexions.

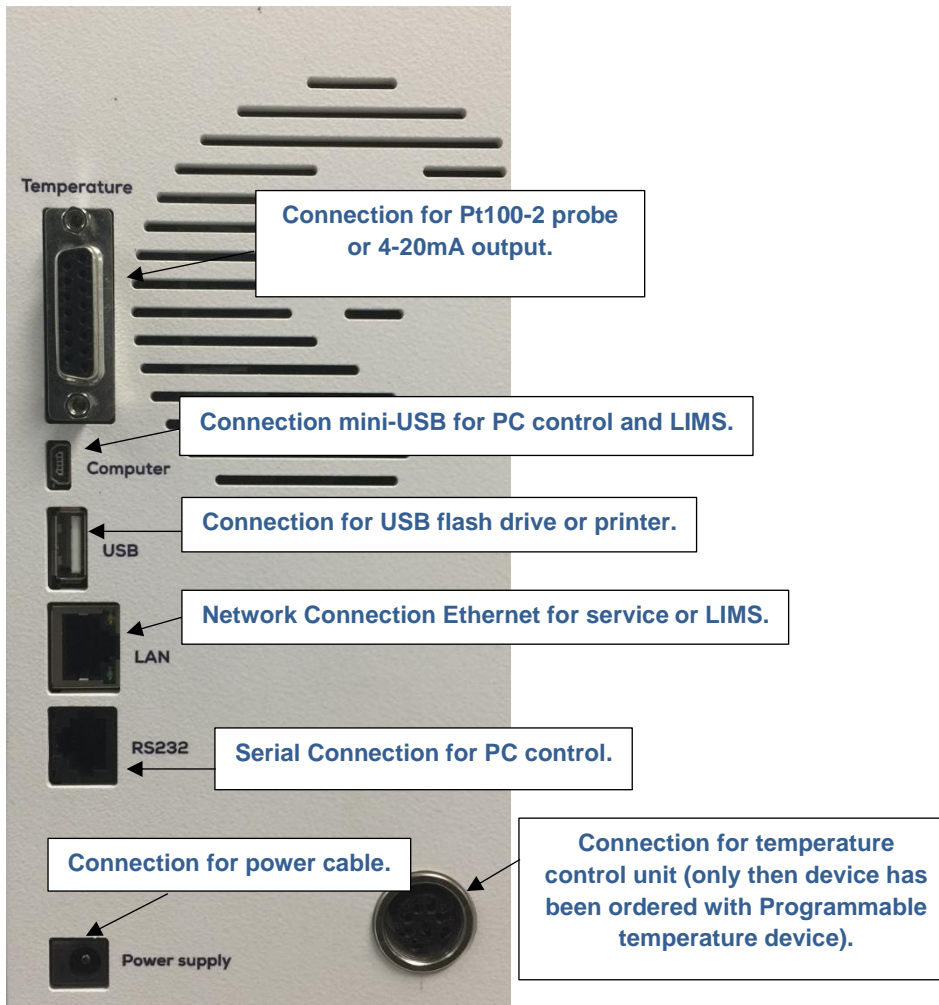

1.4 Specifications

Type of instrument: Rotating springless instrument with 7" Touch screen

Rotation speeds: Unlimited number of speeds between 0.3 and 1500 rpm

Torque range: From 0.05 to 30 mNm.

Accuracy: +/- 1 % of the full scale

Repeatability: +/- 0,2 %

Display: Viscosity – Speed – Torque – Time - Temperature - Choice of viscosity units: cP/Poises or mPa.s / Pa.s

Language: French/English/Russian/Spanish/Turkish/German/Italian.

Compatible measuring system: MS DIN, MS RV/LV, MS BV, MS VANE, MS ULV, MS SV, T-Bars, MS-R.

Compatible temperature control: EVA LR-BV, RT-1, EVA MS DIN, EVA MS-R

Supply voltage: 90-240 VAC 50/60 Hz

Connection: USB

Options: See brochure

Dimensions and weight: Head: Diameter 95 mm Height 180 mm, Box: L120 x W145 x H260mm, Weight: 3 kg

1.5 Installation

So part of this installation manual concerns device equipped with laboratory stand. Installation of RM100i is very easy. You just connect the head to the electronic box and plug it to supply voltage with the hand of supply voltage box. If device is installed on user setup, LAMY RHEOLOGY can provide some specific holder and flange to install it on production area. The cable that connects the measuring head to electronic box get a length of 2m. It is possible to add three extensions of 5m maximum to reach a total length of 17m. An external temperature probe can be connected to the electronic box as well as a 4-20mA link according to the following diagram (please contact LAMY RHEOLOGY for settings).

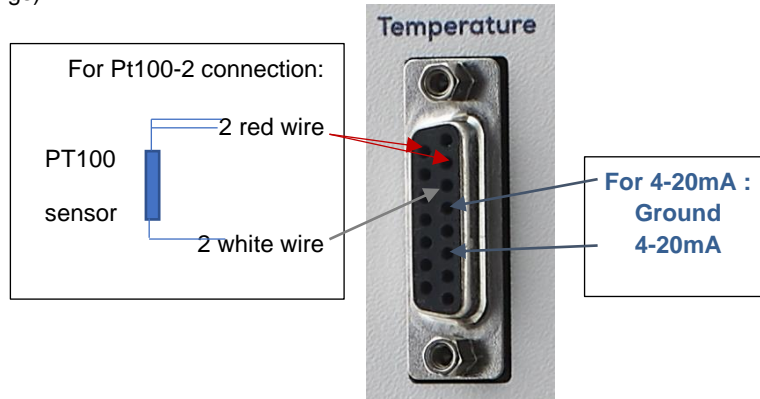

FOR LABORATORY USE WITH STAND.

Your viscometer should be installed in a clean, vibration-free environment. Even if no level is necessary, choose a stable and flat table. This installation notice concern only viscometer without any temperature device. If you have it, please refer to specific notice of temperature unit for installation.

For standard and rack stand: After unpacking all accessories from the box (or case if it is supplied), you must first screw the rod to the base with the help of the screw and the key provided.



For standard stand: Then make sure to insert the white Delrin cylinder and set it to the lowest position. Then place the stop ring on the stainless-steel rod. Then place arm on rod, respecting the direction as described below. The arm is equipped with two buttons and a handle. You can change them for your convenience if you are left-handed.

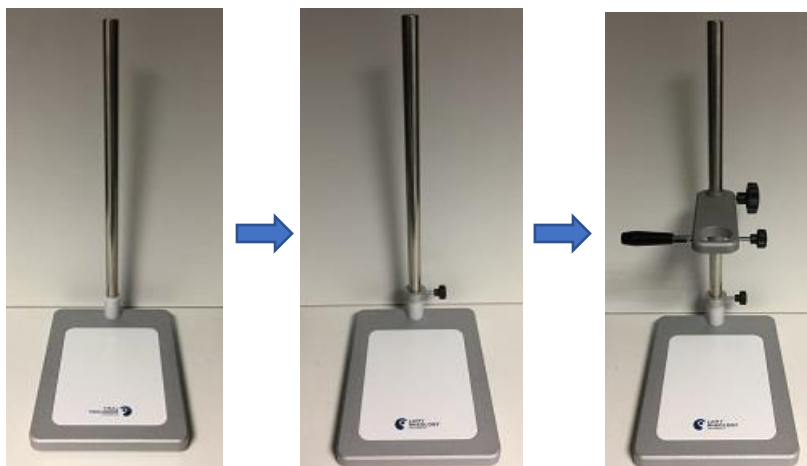

For standard and rack stand: You can then put the instrument on the arm, taking care not to touch the motor shaft or temperature sensor (if your device has one). Align the measuring head correctly and secure it with the screw provided.



Connect your instrument by plugging power cable on to rear panel of device. Also cable for software connection and for temperature control unit (EVA or RT-1/THERMOCELL) when they are provided.









Your instrument will be used with different measuring system. To know how to mount and use it, please see section 3.

2 GETTING STARTED

Once power cable has been plugged on rear panel of device (see section 1.3), you can click on button to switch on your device (see section 1.2).

2.1 State icons

Once your device is switched on, you will see some icons on Touch Screen.

	No Device is connected to the instrument.
	Only one Device is connected to the instrument.
	Two Devices are connected to the instrument.
	Give you the temperature of probe in the sample.
	Enable to go to parameters of instrument.
	Enable to come back to Main Menu.
	Enable to come back to previous menu.

Some instruments are equipped with an external temperature sensor. When it has been ordered, the temperature display is shown at the top right of the screen. If this is not the case, see section 2.6.9 to enable reading. The USB port icon indicates that a USB flash drive has been connected. This is used to update the firmware or to transfer the results.

2.2 Main Menu

Main menu enable you to browse between different tabs of your instrument. Acces is always available by clicking. 

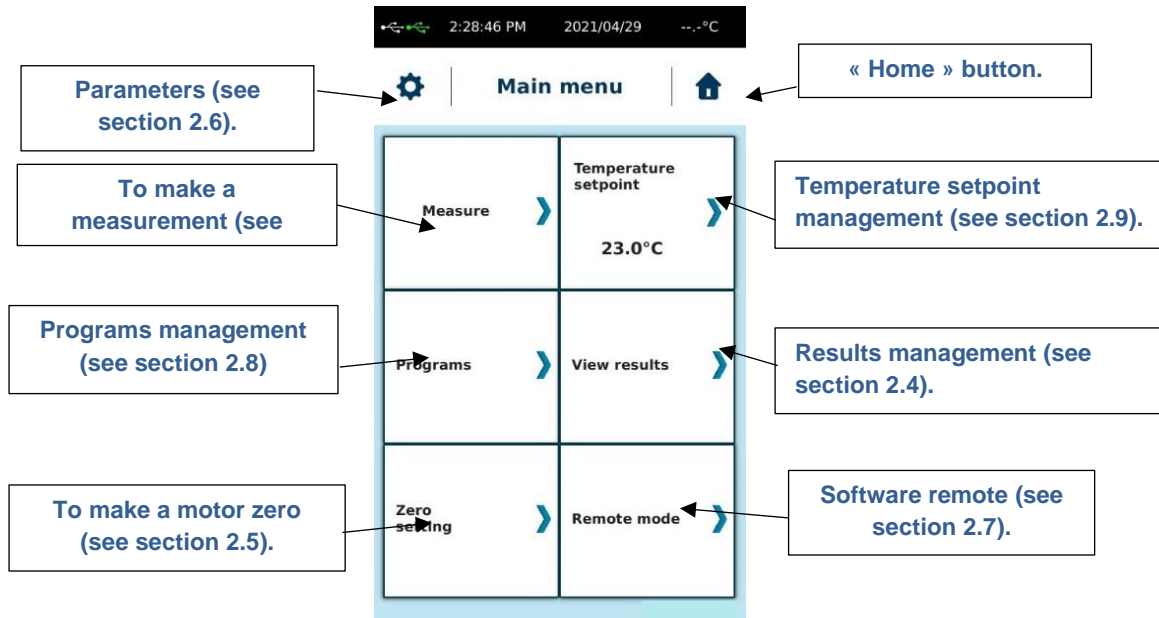

The "Temperature setpoint" button is present when the instrument has been ordered and delivered with a programmable temperature control such as EVA or THERMOCELL / RT-1. If you purchase such a unit at a later date, we invite you to contact LAMY RHEOLOGY or your local agent to activate this function.

2.3 Measure menu

Measure tab is central part of your instrument. Before to use it, you should install your measuring system and your sample (please see section 3).

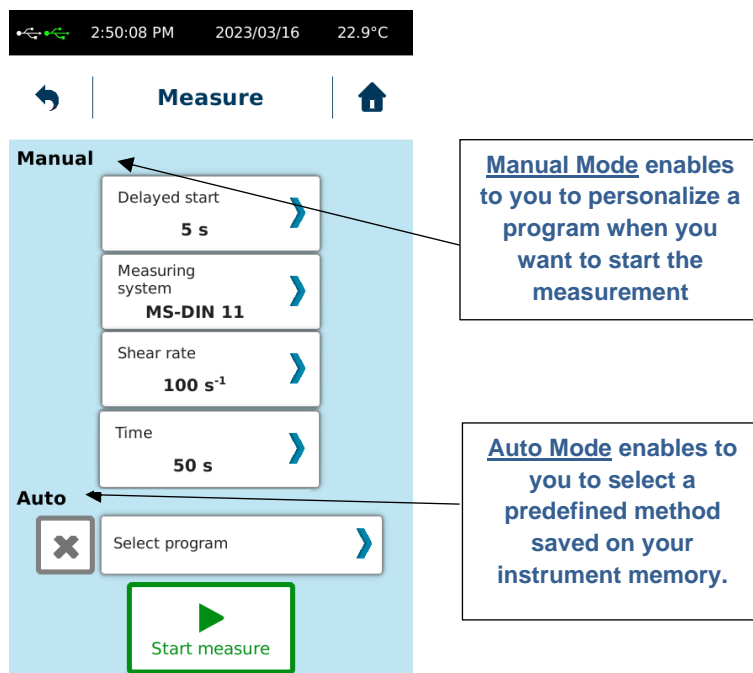

2.3.1 Manual measure mode

Manual Mode enables to choose your measurement parameters like “Measuring System”, “Speed or shear rate”, “Time of measurement” and “Delayed start”.

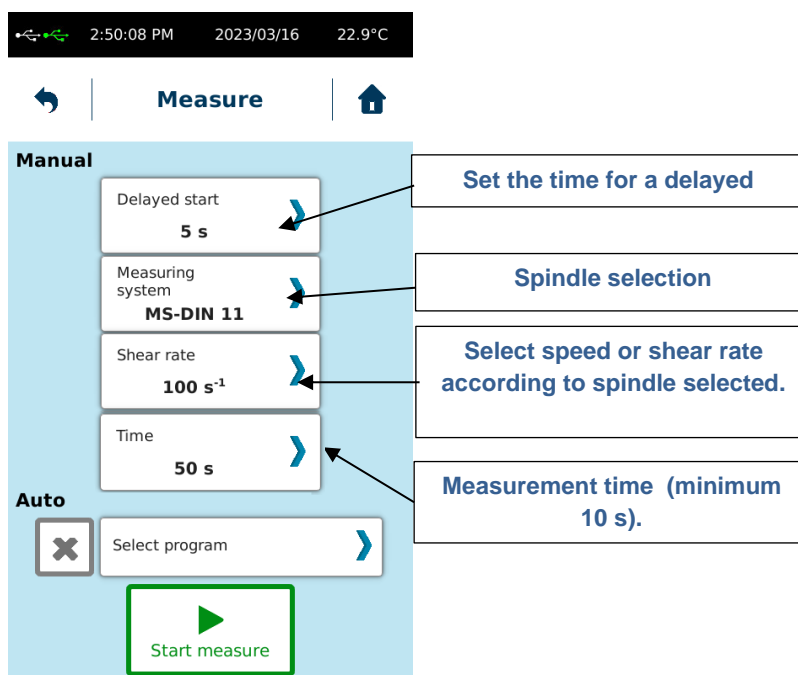

Rq : If « Time » = 0, you could modify « speed » during the measurement. This could help you to define the best conditions to work on your sample.

If your measuring system is not in list, you may have to create it. Please refer to section 2.6.6.

Choice between “Speed” or “Shear rate” is according to your measuring system. For MS RV/LV, MS BV, MS KREBS and MS VANE, you should have only possibility to set the speed. For all other measuring system, you can use shear rate or speed if you force it to show rpm (see section 2.6.9). If you need to know what is the corresponding speed then you are using shear rate, you have to use constant K_D of your measuring system (information available in section 2.6.6).

$$\text{SPEED} = \text{SHEAR RATE} / K_D$$

With speed unit in rpm, shear rate in s⁻¹ and K_D is rpm/s⁻¹.

When your parameters are entered, make sure that the zero adjustment of the motor has been performed before starting your measurement. Depending on the model of instrument you have, the procedure may be different (see section 2.5).

Make sure that the measuring system you are using has been correctly installed (see section 3).

When all these checks have been carried out, you can click on "Start measure" to start your measurement.

If a delayed start has been requested, the instrument displays a countdown then switches to the next view.

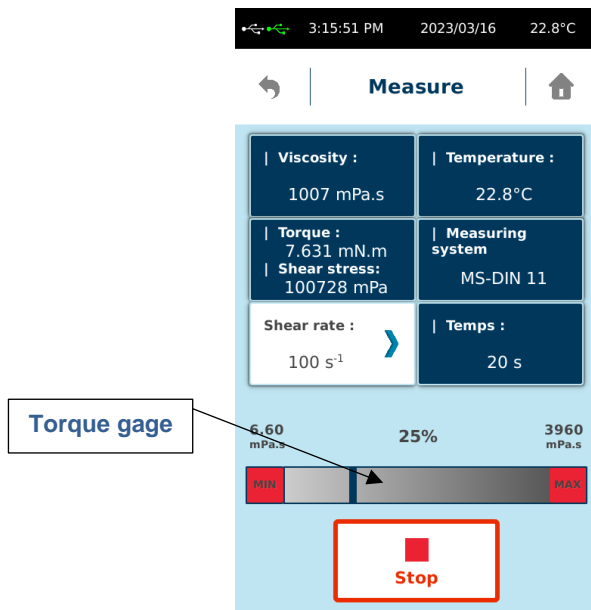

While measurement in manual mode you will see a torque gage (on the bottom side of the display). Boundaries of this gage give you minimum and maximum viscosity you can measure with your selected spindle and set speed/shear rate. You have also value in % corresponding of measured torque vs maximum torque of device. This maximum torque or viewing % can be set on device (see section 2.6.8 and 2.6.9).

You must verify that the measured torque is not too close to the upper or lower limit, because you can get message as “Lower Torque” or “Torque Overload” and measurement will stop automatically. If this is the case, increase speed/shear rate or take a larger measurement system if you are close to the lower limit. Please decrease speed/shear rate or choose a smaller measurement system if the torque reading is close to the upper limit.

You will find several information available on the screen such as torque (mN.m), Shear stress (Pa, can be set on section 2.6.9), temperature (° C), time (s) or viscosity (mPa.s). If the units do not suit you, you can change them in parameters (see section 2.6.5).

Then your measurement is finished, you will get this window below. You will find all data you need and get possibility to save them into internal memory or print it if printer is connected. If you choose “Save”, instrument will ask you to give a name of your measurement. You will have after possibility to read it later (see section 2.4).

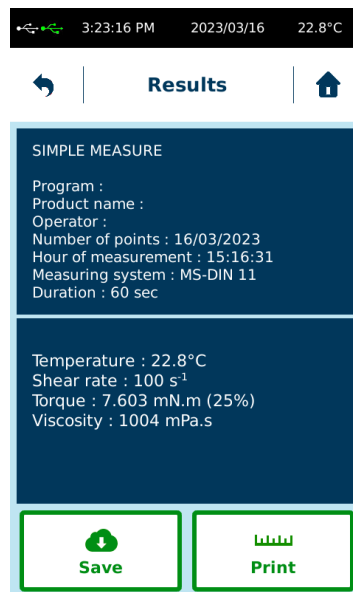

2.3.2 Automatic measure mode

Auto mode allows you to select pre-recorded programs (see section 2.8). Press "Select program" to see the list of saved method.

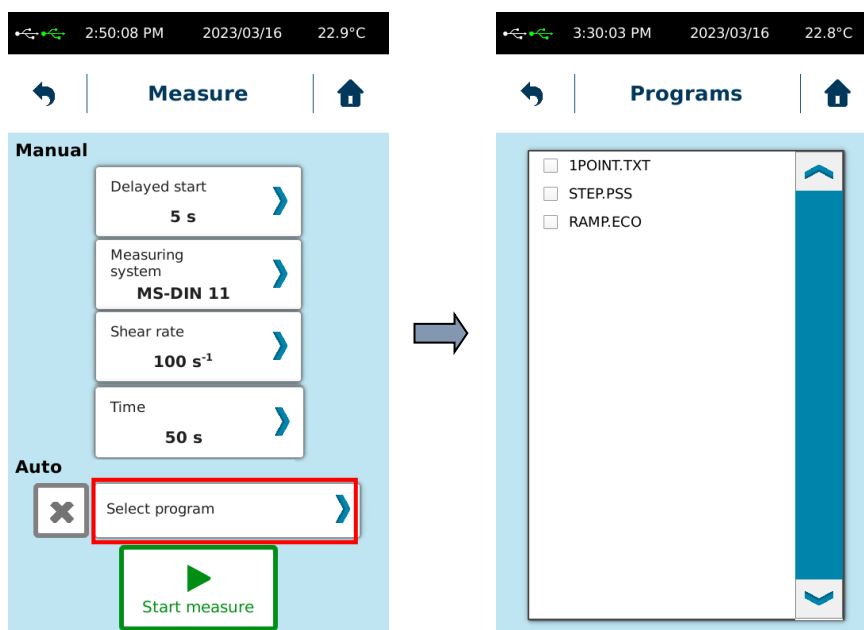

The extension shown next to the program name indicates the type of method according to: "*.TXT" for 1-point method, "*.PSS" for step method and "*".

Select the program to use. The instrument displays the measurement view with some information from the selected method.

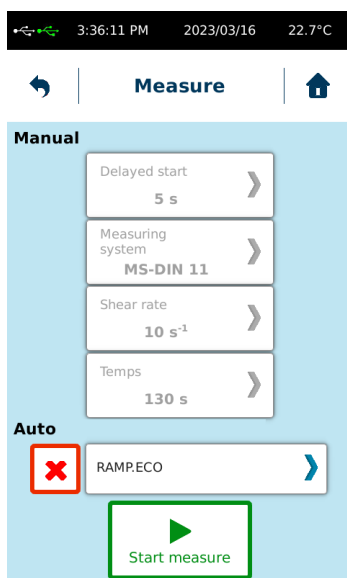

If you made a mistake in choosing the method, you can use the symbol  to allow you a new selection.

When your parameters are entered, make sure that the zero adjustment of the motor has been performed before starting your measurement. Depending on the model of instrument you have, the procedure may be different (see section 2.5).

Make sure that the measuring system you are using has been correctly installed (see section 3).

When all these checks have been carried out, you can click on "Start measure" to start your measurement.

2.3.2.1 1 point method measure mode

The results displayed during the measurement is no different from the manual mode with simple measurement (see paragraph 2.3.1).

At the end of measure, instrument show you this new window with important information according to settings of your method.

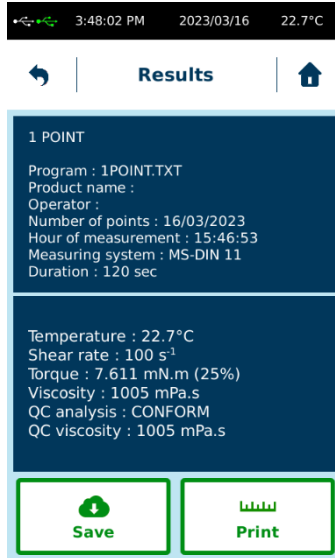

Additionally, to explication on section 2.3.1, you see type of method with name of program on first part of display. On second part of display, you show information about QC analysis if your program had it (see section 2.8.1.1). “QC viscosity” is the measured value used for “QC analysis”.

You will find all data you need and get possibility to save them into internal memory or print it if printer is connected. If you choose “Save”, instrument will ask you to give a name of your measurement. You will have after possibility to read it later (see section 2.4).

2.3.2.2 Step method measure mode

After starting the measurement using a step method, the instrument asks you for a file name to save in its memory.

If a delayed start has been requested, the instrument displays a countdown then switches to the next view.

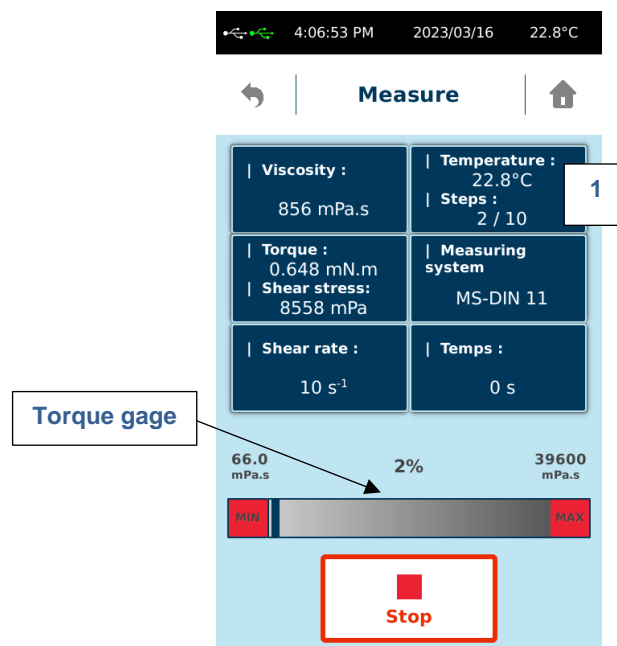

During your measurement, the instrument displays several information. The case marked "1" changes during the measurement. If you have set a setpoint temperature with a start when the setpoint is reached (see section 2.8.1.2), the instrument displays the current temperature and the elapsed waiting time. When the setpoint condition is reached, case "1" switches to the display of the step in progress.

The instrument displays a torque gauge with displayed viscosity limits calculated according to measuring spindle used and the speed or shear rate of each step in progress. The percentage value indicates the ratio between the measured torque and the total torque of the instrument. This maximum torque or percentage display can be set on the device (see section 2.6.8 and 2.6.9).

You must check that the measured torque is not near the upper or lower limit, because you may get the message "Torque too low" or "Torque too high" and the measurement will stop automatically. If so, increase the speed or shear rate of your method's steps or use a larger measuring system if you are near the lower limit. Please decrease the speed or shear rate or choose a smaller measurement system if the torque reading is near the upper limit.

You will find several information available on the screen such as torque (mN.m), stress (Pa) (see section 2.6.9 to display this variable), temperature (°C), time (s) or viscosity (mPa.s). If the units do not suit you, you can change them in the settings (see section 2.6.5).

When your measurement is finished, you will get the window below. You will find all the data you need and will be able to print it if a printer is connected. The instrument displays the results of the rheological analysis and the "QC limits" analysis if your method includes these options (see paragraph 2.8.1.2). Note that the "QC Limits" analysis is performed on the viscosity measured during the last measured step (displayed on the screen after "QC Viscosity"). The data having been automatically saved in memory and you will then be able to read them later (see section 2.4).

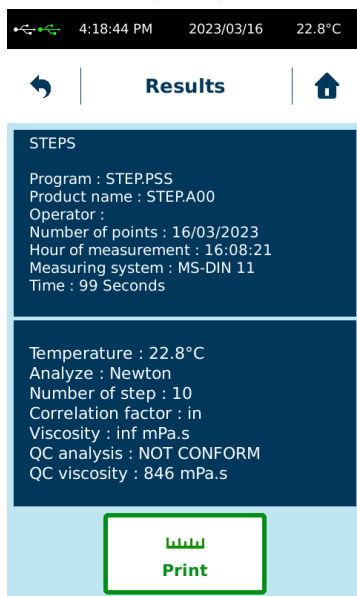

2.4 View results menu

This menu allow you to read, export or delete data from internal memory. Press on « View results » tab in Main menu.

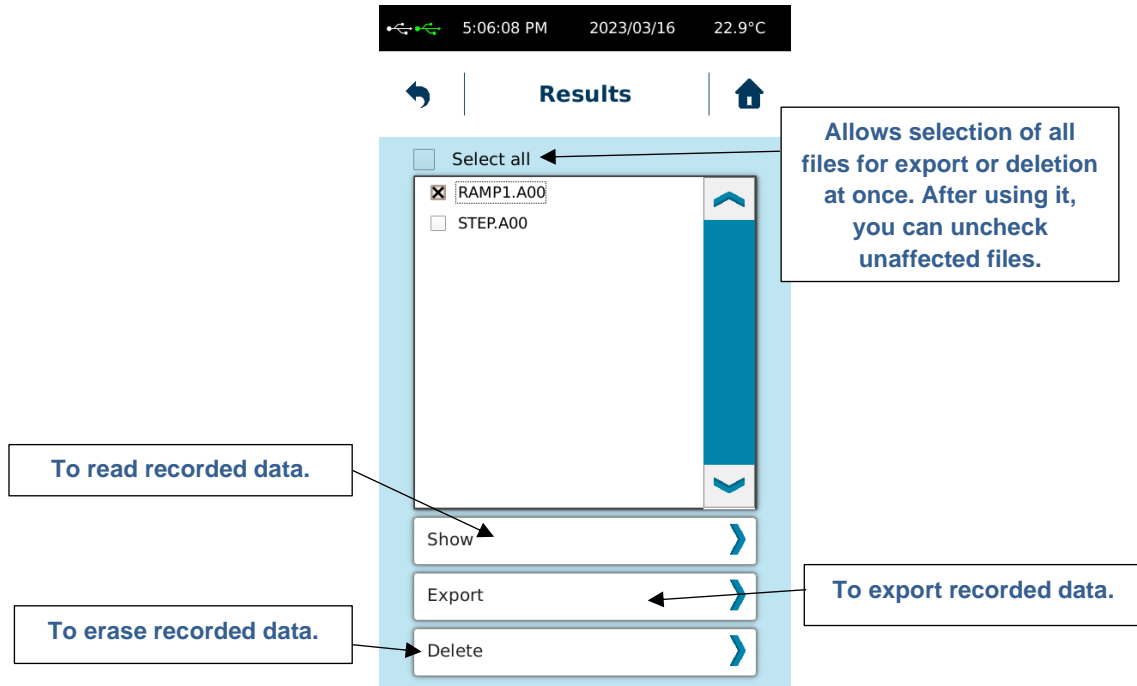

2.4.1 Show results

By clicking on this tab, you will be able to view the information concerning the selected measure. The data display format is the same as the one you get at the end of the measurement (see paragraph 2.3.2). You also have the possibility of printing or exporting depending on whether a printer or a USB key is connected to the instrument.

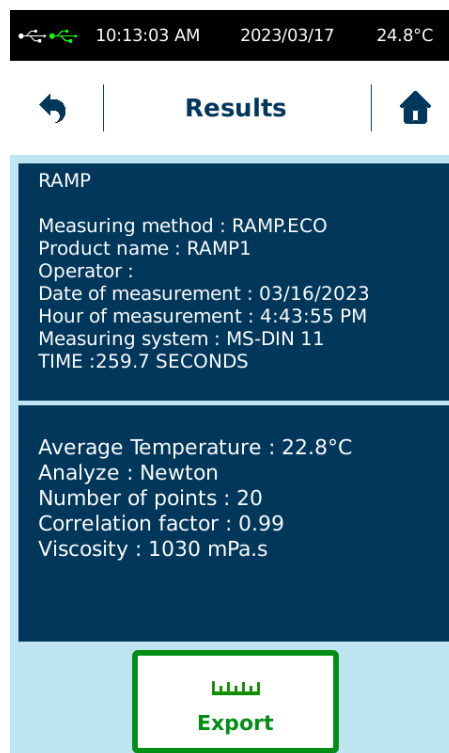

2.4.2 Export results

By clicking on "Export" you can transfer the measurements recorded to a USB key if it is connected to the back (see section 1.3). The "Select all" function allows you to export all the measurements at once.

The format of the data generated and saved by the instrument is ASCII (*.txt). Once your data has been copied to the USB drive, you can open the files using the EXCEL spreadsheet. To do this, simply copy the data from the USB key to your computer. Then open Excel, choose "File", "Open", taking care to select "All files *.*".

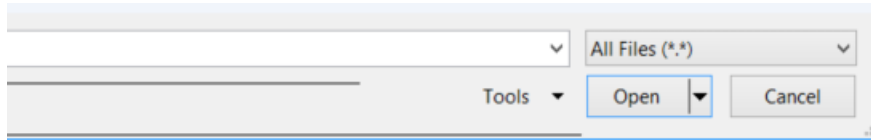

Find your file and click "Open". Excel will offer you to convert your data by displaying three successive windows.

Select "Unicode UTF8" and "My data has Header" (last selection available according Office version) and click "Next".

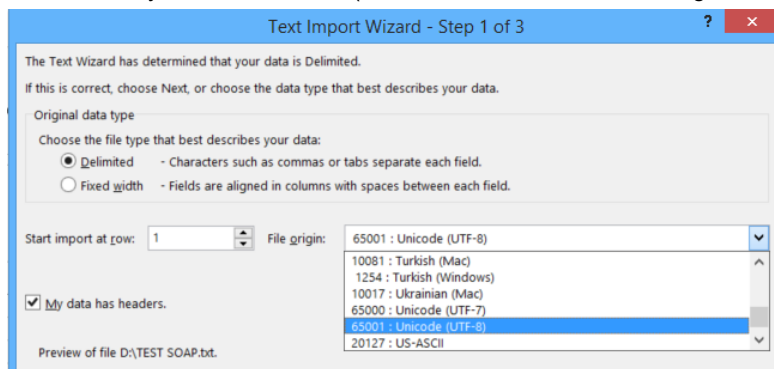

On second step, it will be necessary to choose the option "Tab" and "Semicolon" for separation of the columns. For "Text qualifier", you should set "none".

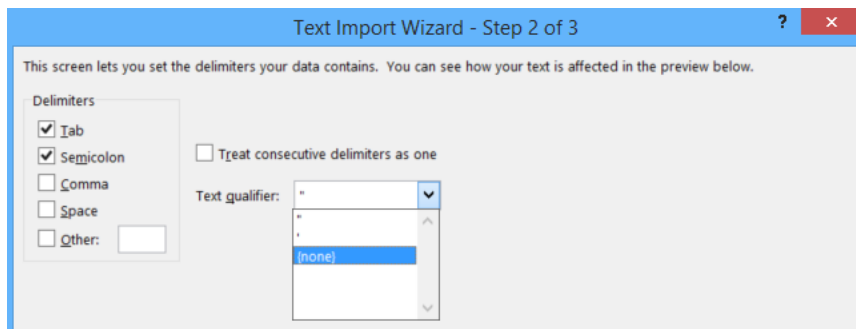

On last step, please choose "General" and click "Finish".

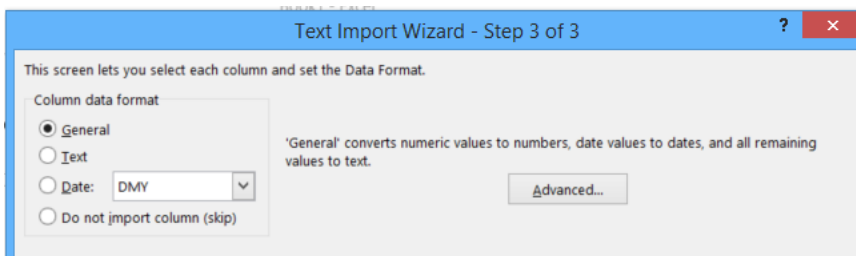

You can then see your measurement results with the possibility to save a new file in Excel format.

2.4.3 Delete results

By clicking on this tab, you can delete all the measurements recorded on your instrument. The "Select all" function allows you to delete all the measurements at once.

When you click "Delete", the recorded data will be completely deleted from the internal memory after further confirmation from you.

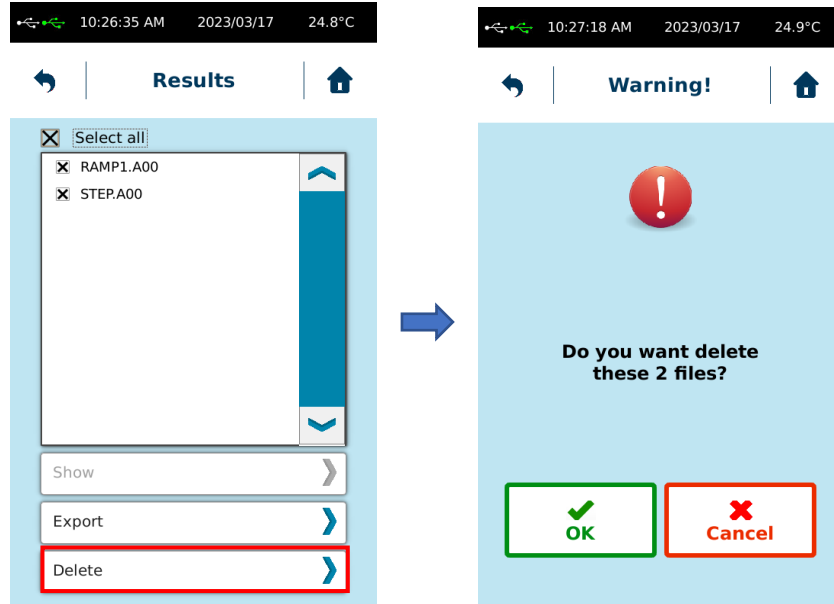

2.5 Zero setting

The zero setting allows you to calibrate your instrument to take account of the engine's empty friction.

Zero setting allows you to calibrate your instrument and take care of motor internal friction.

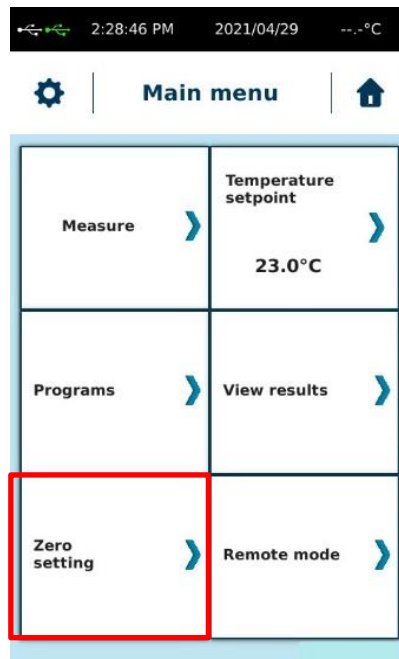

For standard instruments, this operation must be done without mobile. The rotational speed for zero adjustment is available on the same window. The rotation speed for zero adjustment can be changed to suit your needs, giving you much more accurate measurements at specific speeds near to your measurement parameters.

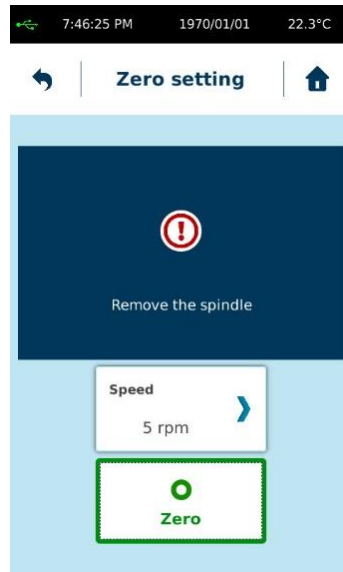

Then zero is finish you can click on OK and internal motor friction will be automatically saved inside memory of instrument. If problem occur during zero setting, please try again. If problem still present, please contact your local distributor or society LAMY RHEOLOGY.

2.6 Parameters menu

This parameters menu allows you to change settings of your device. It is reachable by clicking on icon “⚙️” in upper left corner of touch screen.

This icon is only available then you are in “Main menu”.



2.6.1 Languages

Enable you to select language of your instruments. You have choice between French, English, Russian, Turkish, Deutsche, Italian and Spanish. Then you have selected your desired language, you have to click on “Ok” and device will reboot automatically to show new language. In this menu you will be able to see Firmware version of your device.

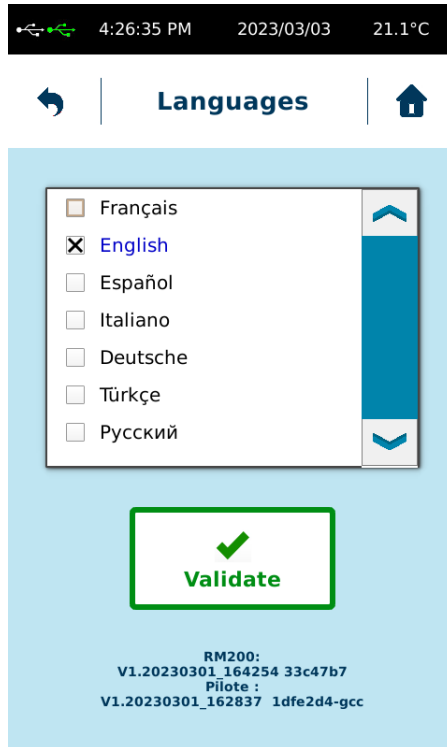

2.6.2 Date / Hour

Enable you to adjust hour and date of your instrument. On this location, you can also set date for next checking of device. Soon this date will be reached, device will show you message as device need to be checked.

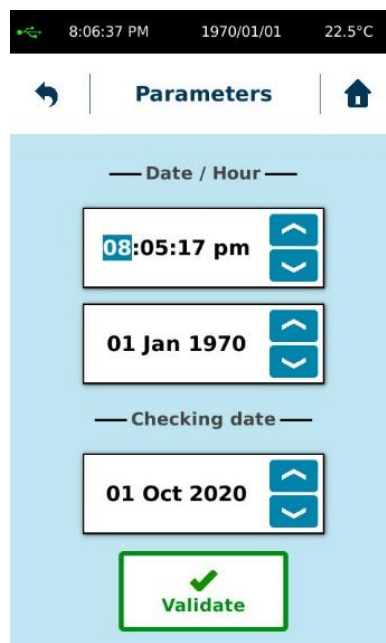

2.6.3 Sounds/Standby/Lighting

Allow you to modify sounds, lighting and activate or not the Standby mode of your instrument.

Choose if you want to get sound during using touch screen.

Choose if you want to get sound then measurement is finished.

Choose if you want to change brightness of Touch Screen.

Choose if you want to switch off automatically your device after no using. After selecting "Standby enable", you will have to set time. Your device will be switch off after this time.

The screenshot shows the 'Parameters' screen with the following settings: 'keys bip' set to 'Yes', 'buzz end of measure' set to 'Yes', a brightness slider, 'Standby Enable' checked, and 'Standby delay' set to 00:30:00. Callout boxes provide instructions for each setting.

2.6.4 User Name

Operator mode will allow you to create different operators for your instrument. The use of the operators makes it possible to identify the person making the measurement (to save name on saved file and see later who made this measurement) or lock some function on device for simple user.

Operator management must always begin with the creation of the first account, which will become the administrator and thus create or delete another operator account. Click on "Create new user with PIN code". After specifying the name and password, the administrator will be named in red in the list.

The first screenshot shows the 'Parameters' screen with a list of options: 'Create new user with PIN code', 'Create new user without PIN code', 'Delete user name', and 'Enable User mode'. The 'Create new user with PIN code' option is highlighted with a red box. A blue arrow points to the second screenshot, which shows the same screen after a new user named 'SGU' has been created and is listed at the top of the list.

You can now create another operator. The account of an operator may or may not be associated with a password (here called PIN code).

To delete an account, the administrator account must be used. Select the account you want to delete from the list and click on "Delete user name".

To use the operator accounts you must activate the mode by click "Enable User mode". Device will ask you to select user name you want to use. By returning to the Main Menu, you will see the name of the operator in use. By clicking on the arrow below the name of the operator, you can switch off the instrument or change operator. Click on "Logout" and device will ask you operator account you want to use

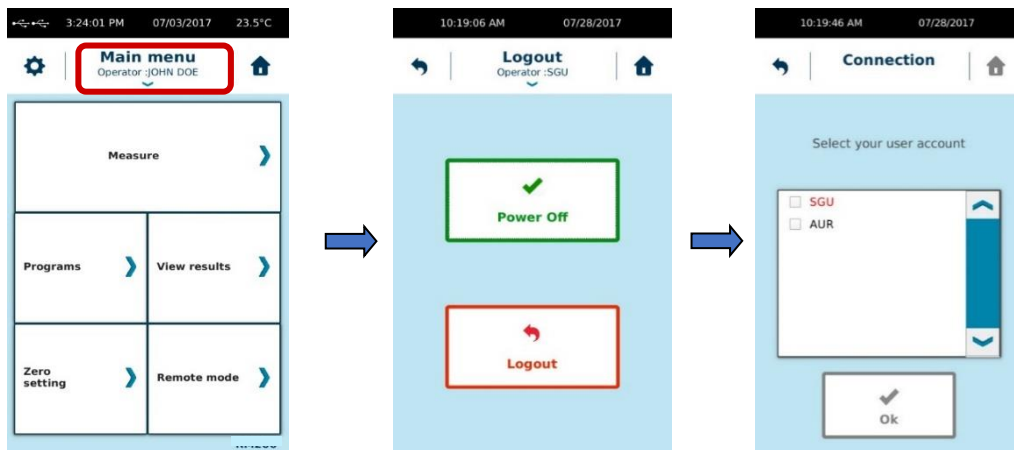

If the instrument is switched OFF and ON while operator mode is activated, device will ask you to select the operator you want use.

When User mode is enabled, some functions will be not editable for simple user as picture below shows it.

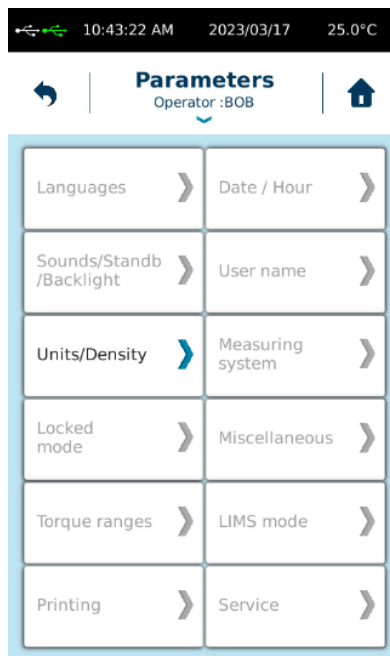

2.6.5 Units/Density

Enable you to change unit of viscosity values and to enter density value of your product to measure in order to calculate its kinematic viscosity.

If you set a density value, you will get all the time kinematic viscosity in cStoke. Please remove density information if you want to get back Pa.s or Poise for unit of viscosity.

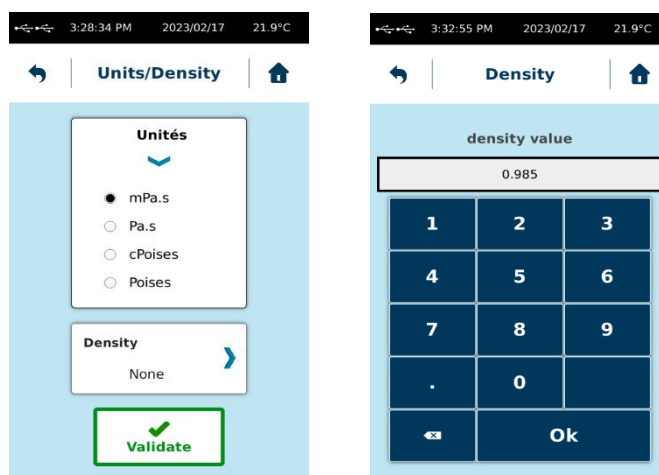

2.6.6 Measuring System

Allows you to add, copy or delete a Measurement System.

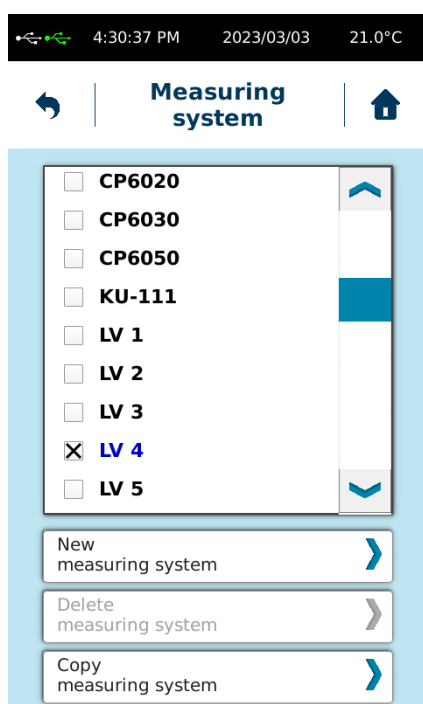

All measurement systems stored by default in memory are not removable. Only those you have created yourself can be removed. To delete a measuring system, select it from the list and choose "Delete Measuring System". If this function remains greyed out when you have selected a system, it is part of the default mobile stored in the instrument's memory.

To add a new measuring system, you can use "New measuring system" or "Copy measuring system" functions. Device will ask you name and constants for this measuring system. In case of copy, device will propose you to keep constant from previous measuring system but you can modify them.

You are not allowed to change the constant of an existing measuring system. If you want to use a new constant for an existing measuring system, you have to copy and modify it. Note that the KD constant is used to convert rotational speed to shear rate and K τ to convert torque to shear stress. Shear rate and shear stress are used to calculate the viscosity value. If you use a different constant value, you will get a different viscosity result.

Here is the list of constants used for measuring systems compatible with the instrument.

MS BV

SYSTEM	Ktau / 1 mNm in Pa	Kd / 1 RPM in S-1	Ri / Ra
BV 1	6,1	1,001	1
BV 10	25,5	0,5	0,7
BV 100	76,5	0,15	0,5
BV 1000	510	0,1	0,5

MS RV/LV

SYSTEM	Ktau / 1 mNm in Pa	Kd / 1 RPM in S-1	Ri / Ra
RV 1	13,91	1	1
RV 2	55,65	1	1
RV 3	139,1	1	1
RV 4	278,2	1	1
RV 5	556,5	1	1
RV 6	1391	1	1
RV 7	5565	1	1
LV 1	106	1	1
LV 2	500	1	1
LV 3	1900	1	1
LV 4	8600	1	1
LV 5	17826	1	1

MS VANE

SYSTEM	Ktau / 1 mNm in Pa	Kd / 1 RPM in S-1	Ri / Ra
V71	36.5	1	0.5
V72	157	1	0.5
V72/2	270	1	0.5
V72/4	400	1	0.5
V72/6P	150	1	0.5
V-73	785	1	0.5
V-74	7850	1	0.5
V-75	2965	1	0.5
VT105	2180	1	0.5
VT2010	410	1	0.5
VT2020	59	1	0.5
VT3015	80	1	0.5
VT4020	34	1	0.5
VT4040	7.4	1	0.5
VT5025	17	1	0.5
VT6015	43	1	0.5
VT6030	10	1	0.5
VT608	150	1	0.5
VT8040	4.2	1	0.5
VT8070	1.2	1	0.5

MS DIN

SYSTEM	Ktau / 1 mNm in Pa	Kd / 1 RPM in S-1	Ri / Ra
MS-DIN 11	13.2	1.291	0.92
MS-DIN 12	19.4	0.354	0.73
MS-DIN 13	64.4	0.152	0.43
MS-DIN 22	25.8	1.291	0.92
MS-DIN 23	77.9	0.19	0.54
MS-DIN 33	130.1	1.291	0.92
MS-DIN 19	12.56	3.223	0.97

MS SV and MS ULV

SYSTEM	Ktau / 1 mNm in Pa	Kd / 1 RPM in S-1	Ri / Ra
SV414	877	0.4	0.69
SV415	371	0.48	0.75
SV416	572	0.29	0.53
SV418	59.7	1.32	0.92
SV421	65.9	0.93	0.88
SV425	1918	0.22	0.25
SV427	126.8	0.34	0.62
SV428	205.2	0.28	0.49
SV429	367	0.25	0.40
SV431	166.5	0.338	0.62
SV434	271	0.28	0.49
SVC	68	0.43	0.71
SVTR8	66.15	0.92	0.88
SVTR9	127	0.34	0.62
SVTR10	204	0.28	0.49
SVTR11	374	0.25	0.40
MS-ULV	33.1	2.04	0.95

T-Bars

SYSTEM	Ktau / 1 mNm in Pa	Kd / 1 RPM in S-1	Ri / Ra
T-A 92	278	1	1
T-B 93	557	1	1
T-C 94	1392	1	1
T-D 95	2783	1	1
T-E 96	6957	1	1
T-F 97	13914	1	1

MS-R

SYSTEM	Ktau / 1 mNm in Pa	Kd / 1 RPM in S-1	Ri / Ra
MS-R 1 / 75	5159.8	1	1
MS-R 2	12.68	0.35	1
MS-R 3	64.8	0.3	1
MS-R 4	300	0.25	1
MS-R 5	475	0.1	0.5

2.6.7 Locked Mode

This option allows you to block measuring parameters. It should be set by an administrator or responsible of the device.

This function is not comparable to the "User name" menu (please see section 2.6.4). It should be use if you want to protect measurement settings on your device. All settings will be not lock by this function. You will see below which settings are concerned.

This function will block also parameters for measure. In this way, if you want to use all the time same parameters for measurement, you should enable this locked mode to be sure that nobody will change settings for measurement.

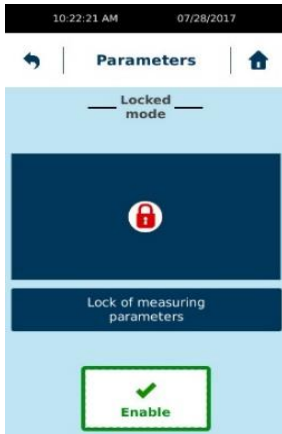

When you click "Enable", the instrument will ask you to save a 4-digit code that will be required to disable this protected mode. Each activation is independent and can be done with a different code. The protected mode is indicated by the presence of a padlock-like icon. **BUT TO DISABLE THIS LOCKED MODE, YOU SHOULD USE 4-digit CODE USED TO ENABLE IT.**

Once protected mode is activated, you will see this icone on instrument's screen (see picture below). Protected mode protect programs, measuring parameters and some menu as shown on pictures below.

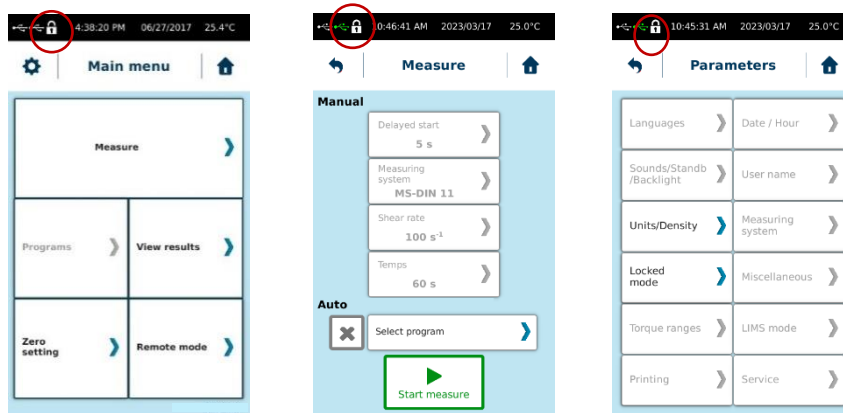

To disable "Locked mode", you must return to service and "Locked mode" and click on "Disable" by entering the 4-digit code.

2.6.8 Torque range

Enable you to adjust the torque range of device according to spring instrument technology. This setting will have effect on torque in % shown while measurement and viscosity limits.

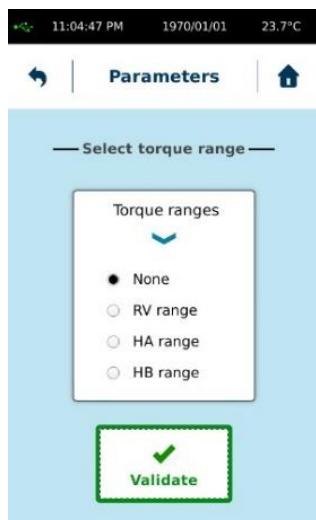

Please see below torque covered by specific range:

- RV Range : From 0.07187 to 0.7187 mNm.
- HA Range : From 0.1437 to 1.4374 mNm.
- HB Range : From 0.5749 to 5.7496 mNm;
- None means no limits. So it will be complete range (from 0.05 to 30 mNm for RM100, RM200 and DSR500 – 0.05 to 13 mNm for standard B-ONE PLUS, FIRST PLUS, FIRST PRO and FIRST PRODIG – 0.005 to 0.8 for all LR device).

2.6.9 Miscellaneous

This menu allows you to select the temperature sensor used by the instrument. The instrument allows the use of an external probe (Pt100-2) which must be connected to the back of the instrument (see section 1.3). This setting is not available by default on instrument if this device is delivered without external temperature probe. If you buy it later and want to activate this function, please contact your local agent or LAMY RHEOLOGY.

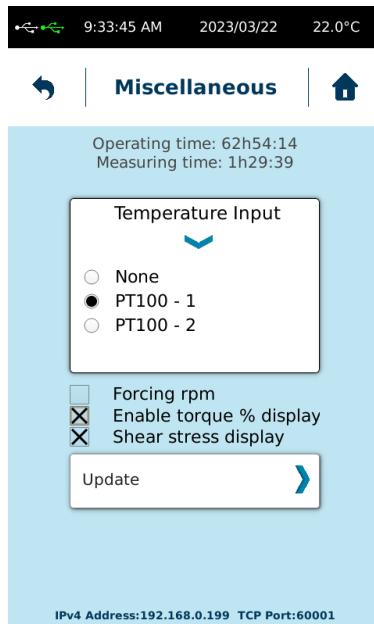

“Update” function is used when updating the machine software is necessary. Do not go in this menu without being invited by the company LAMY RHEOLOGY. The update is done via a USB key connected to the "USB" port. You can then click on "Update" to update your instrument. At the end, your device will turn off and you will have to turn it on again.

“Operating time” and “Measuring time” settings indicate time while device has been switched ON and time while it was used for measurement.

“Forcing rpm” allow you to force device setting only speed in rpm instead shear rate (s-1) when you are using measuring system compliant with DIN 53019 norm (as MS DIN, MS ULV, MS SV).

“Enable torque % display” allow device to show torque in % above torque gage while measurement.

“Shear stress display” function will provide you shear stress value while measuring.

On bottom part of this view, you see information about network identification of this instrument. It helps you to identify instrument when you want to use LIMS function (see section 2.6.10). These parameters can be changed in menu Service (check with your local contact or Lamy Rheology to provide you access).

2.6.10 LIMS mode

This menu allows you to select format of data for LIMS function. Like this you will be able to collect the data stored inside memory of instrument under desired format. The connection used will be Ethernet (LAN) or USB in rear panel of instrument. IP adress of instrument for LAN connection can be changed in service menu. To do that, please contact LAMY RHEOLOGY or your local contact to provide you password for acces.

Intervall time will be used by device to store data point inside memory after defined time for LIMS function.

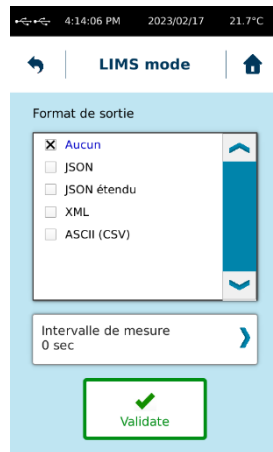

2.6.11 Printing

This menu allows you to connect a printer, print a test page, and choose the print interval time you want during measurement.

The instrument can be connected to all printers with a PCL5 print protocol. This includes many A4 printers. The connection is made to the "USB host" port on the back of the instrument.

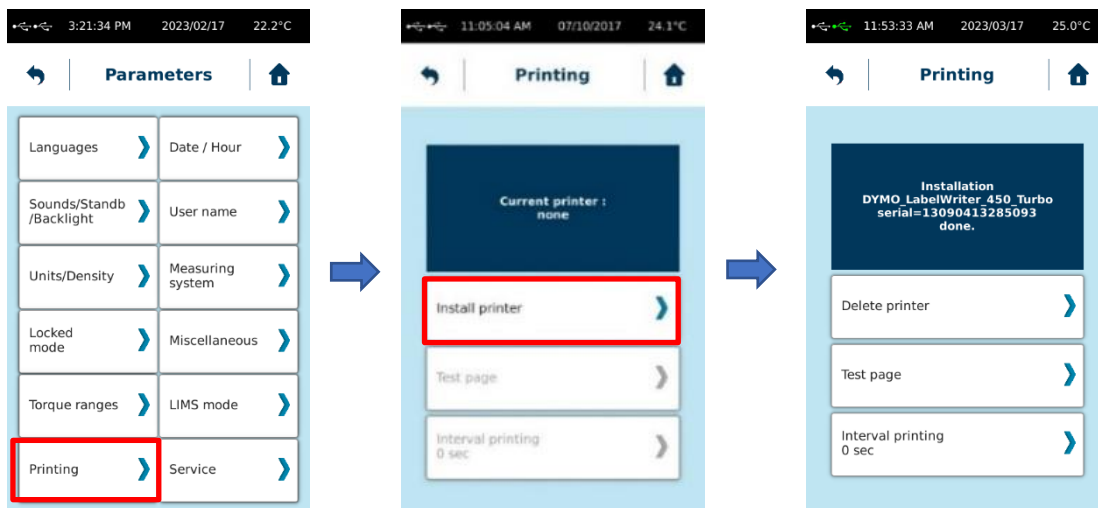

Once the printer is connected, simply click on "Install Printer".

You can also print page for test or set time interval for automatic printing. Then you print data at the end of measure or a saved file, you will have only information shown on device screen as final result. If you want to have more data printed, you have to select "Interval printing" time to get data printed between start and end of your measurement.

2.6.12 Service

Reserved to LAMY RHEOLOGY or local partner engineers.

2.7 Remote mode menu

This mode enables to drive instrument by external RheoTex software (supplied on option) or for LIMS connection (see section 2.6.10). This function is available on the main menu.

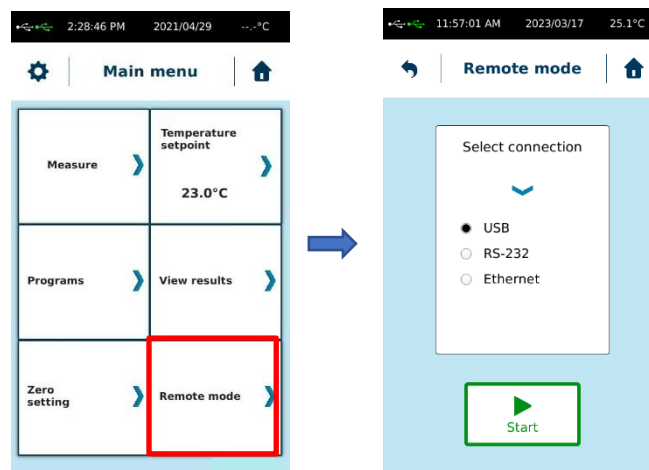

Once the device is connected to the PC, you must select the type of port (USB - RS232 for RheoTex or USB – Ethernet for LIMS) and click on "Start" to launch the communication. As long as communication is not established, a "Waiting Connection ..." message appears on the screen. Then launch the software and check that the screen switches to the display below. If this is not the case, check the connections and make sure that the COM port number set in the default settings of the RheoTex software is correct and identical to that recognized by WINDOWS in "Control Panel", then "System and "Device Management" (see the operating instructions for the RheoTex software).

2.8 Programs menu

In the programs tab you will be able to configure, modify or delete your measurement methods. The saved programs can be found in the "Auto" tab of the "Measure" menu (see section 2.3.2).

When you select the "Programs" function, you get a new window where you can see your recorded methods and functions as "Create program", "Edit Program" or "Delete a program". The "Select all" function can only be used for the deletion of methods.

The extension after the program name indicated the type of method according to: " *.TXT" for 1 point method, " *.PSS" for step method.

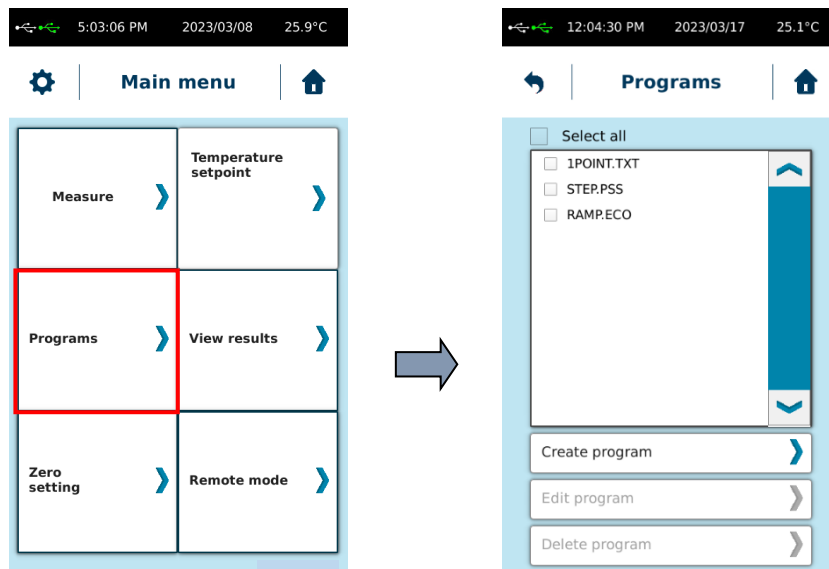

2.8.1 Create new program

By selecting "Create program", the instrument displays the following view.

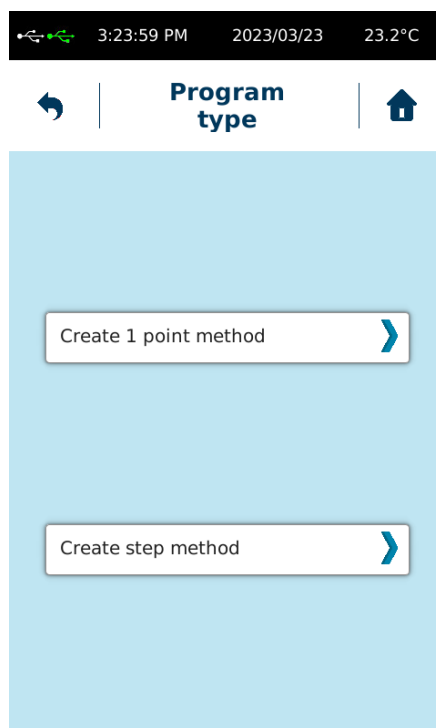

The "1 point method" makes it possible to measure your product viscosity at constant rotation speed or constant shear rate during a defined time. The instrument will display measured viscosity at the end of this measurement time.

The "Step method" allows you to fix measurement intervals at different rotation speed or shear rate in order to obtain viscosity values under different shear conditions. It also makes it possible to obtain a flow curve by fixing interval by interval the shear rate and time.

2.8.1.1 1 point method

When you choose 1 point method, the instrument displays the following view.

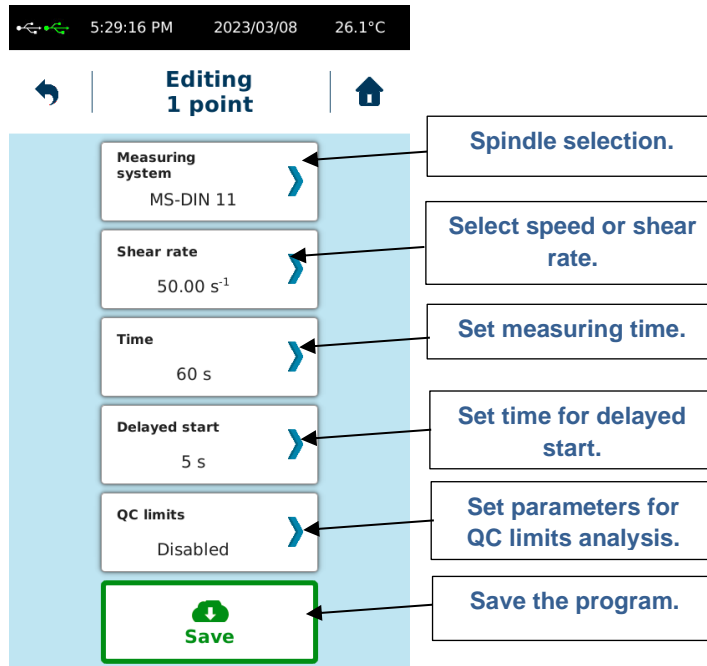

When creating a new method, the next buttons is activated after your validations progresses.

According to the selected mobile, the instrument will offer you to fix the shear rate (s⁻¹) instead speed (rpm) as that is the case for MS DIN or MS SV measuring systems. To force rotation speed in rpm, please read section 2.6.9 of this user manual.

The "Delayed start" function allows you to set a waiting time before the measurement. This time will be deducted as soon as you launch the measurement (see section 2.3).

The "QC limits" function makes it possible to verify that the measured viscosity value is between two limits that you have previously set. When choosing this function, the instrument displays the following view.

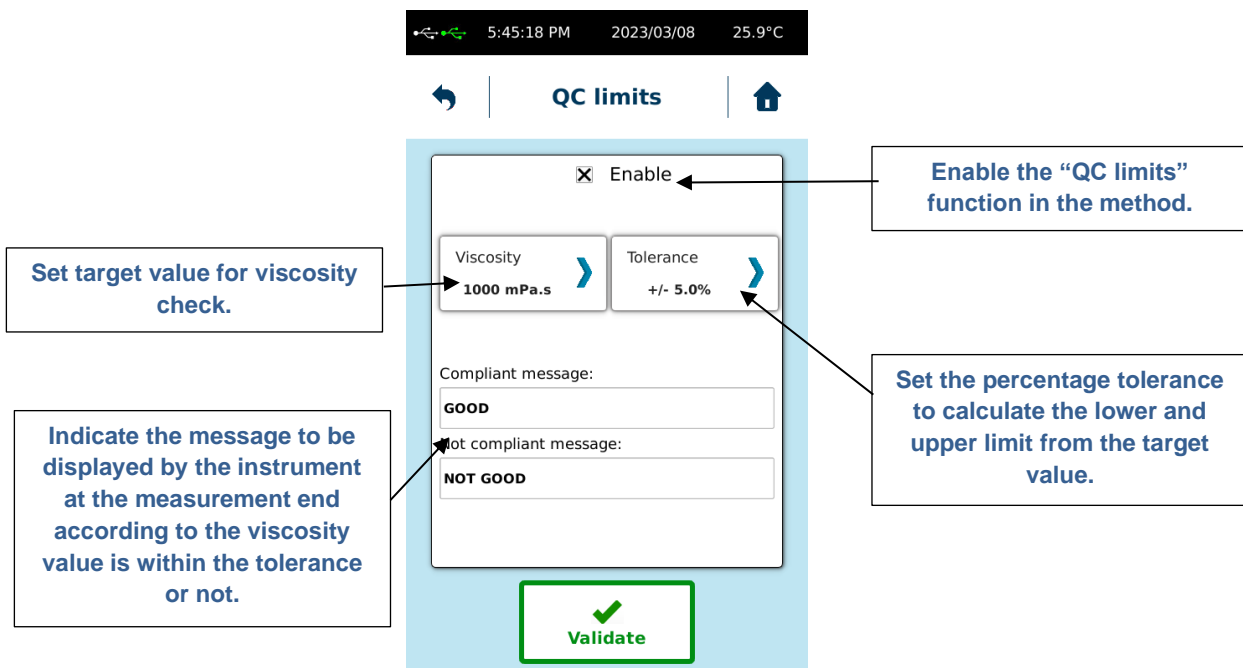

Do not forget to activate the "QC limits" function before validating to exit this window, otherwise the information will not be saved. At the measurement end according to the viscosity value is within the tolerance or not, the instrument will display the message that you have indicated in the "Compliant message" or "Not compliant message" fields.

Once you have finished setting up your method, you can save it by choosing "Save".

2.8.1.2 Step method

When you select step method, you will get the following view.

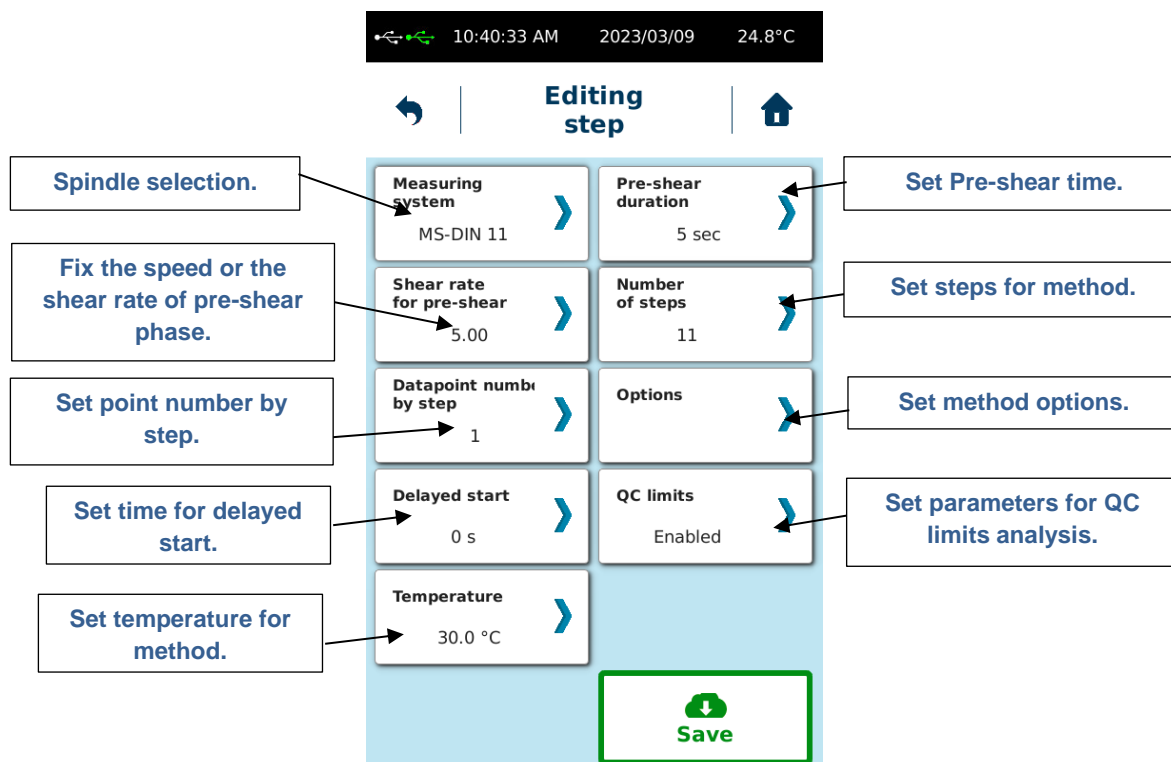

When creating a new method, the next buttons is activated after your validations progresses.

According to the selected mobile, the instrument will offer you to fix the shear rate (s^{-1}) instead speed (rpm) as that is the case for MS DIN or MS SV measuring systems. To force rotation speed in rpm, please read section 2.6.9 of this user manual.

The "Delayed start" function allows you to set a waiting time before the measurement. This time will be deducted as soon as you launch the measurement (see section 2.3).

The "Temperature" button is only present if the function has been activated in the instrument. This is the case when the instrument has been delivered with a programmable temperature regulation. By default, this function is not accessible. If you acquire a temperature control device later, we invite you to contact LAMY RHEOLOGY to activate this function.

The "QC limits" function is identical as defined in paragraph 2.8.1.1.

When you select the “Number of steps” button, the instrument displays a new view.

The screenshot shows the 'Step editor' screen with a list of 10 steps. Each step is represented by a checkbox, a step number, a duration, and a shear rate. The first step is selected. Below the list are buttons for 'Add new step', 'Delete step', 'Edit duration', and 'Edit value'. Callouts provide the following explanations:

- Allows you to select the step for copy, edit or delete.** (Points to the checkbox of the selected step)
- To delete selected step.** (Points to the 'Delete step' button)
- Allows you to change the speed or shear rate of selected step.** (Points to the 'Edit value' button)
- Allows you to copy selected step and then add it after it.** (Points to the 'Add new step' button)
- Allows you to modify the selected step duration.** (Points to the 'Edit duration' button)

Once changes have been done, you can use the button to return to the previous screen. The instrument will display the new number of steps.

The “Options” function allows you to integrate a rheological analysis or a temperature setting condition as described in the following view.

The screenshot shows the 'Options' screen with various settings. Callouts provide the following explanations:

- Select this function if you want the instrument to chain the same succession of steps but in the opposite direction.** (Points to the 'Decreasing ramp' checkbox)
- Allows a rheological analysis to be carried out on the measurement results.** (Points to the rheological analysis model selection list)
- Allows you to indicate on which step you wish to perform a rheological analysis. These buttons are disabled if "Use All Points" is selected.** (Points to the 'First step' and 'Last step' input fields)
- Allows you to wait for the temperature defined in the method to be reached before starting the measurement.** (Points to the 'Start at temperature' checkbox)
- Allows you to use all measuring points for your rheological analysis.** (Points to the 'Use all points' checkbox)
- Allows you to use the points generated by the steps used in the opposite direction. This option is only available if you have checked “Decreasing ramp”** (Points to the 'Use falling curve' checkbox)

The “Start at temperature” option is only interesting if temperature control is activated on your instrument.

The "Decreasing ramp" option is interesting if you want to use the step method to generate a flow curve. This descending part will be carried out following the first succession of steps. The term "Decreasing" means that the instrument will decrease the speed or the shear rate. It is therefore important that, during the first succession of stages, the speed or the shear rate are increasing.

2.8.2 Edit program

This function allows you to modify an existing method. Select a method by checking the corresponding box. The "Edit program" function becomes active and allows you to navigate through the parameters in the same way as described in paragraph 2.8.1. After modifying the method, you have the option of saving it under another name or overwriting the existing method name.

2.8.3 Delete program

This function allows you to delete a method from the instrument memory. Select the method concerned by checking the corresponding box. You can delete them all at the same time by selecting the "Select all" function.

2.9 Temperature setpoint menu

This function is available in the main menu.

As described in paragraph 2.3, this function is only available if your device is delivered with a temperature control that can be controlled such as the EVA, RT-1 PLUS (THERMOCELL) units. By default, this function is inactive. If you subsequently acquire such a heating unit, you should contact LAMY RHEOLOGY or your local agent.

This mode does not allow temperature ramps to be carried out via the instrument. For this type of method, the use of RheoTex software is required.

Contrary to the use of the setpoint in a measurement method (see section 2.8), the use of this function is useful for controlling the temperature setting unit without performing a measurement. So, you can precondition your sample to the right temperature before starting the measurement.

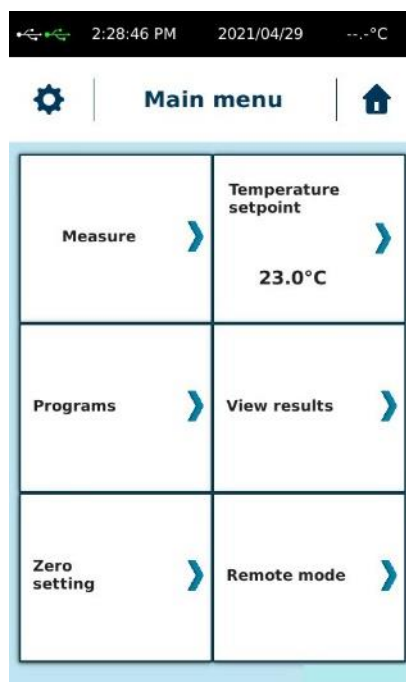

3 MEASURING WITH YOUR DEVICE

This section will show how use the different measuring system with your device.

Instrument need to be installed before next section of this manual (see section 1.5).

3.1 Installation of measuring system

Read the installation of your measuring system in the following sections before inserting it on your instrument. Indeed, some measuring systems require the installation of accessory before the insertion of the spindle.

The RM 100 I can get two kinds of coupling: AC115 or Bayonet coupling.

Then device gets AC115 coupling, motor shaft looks like below.

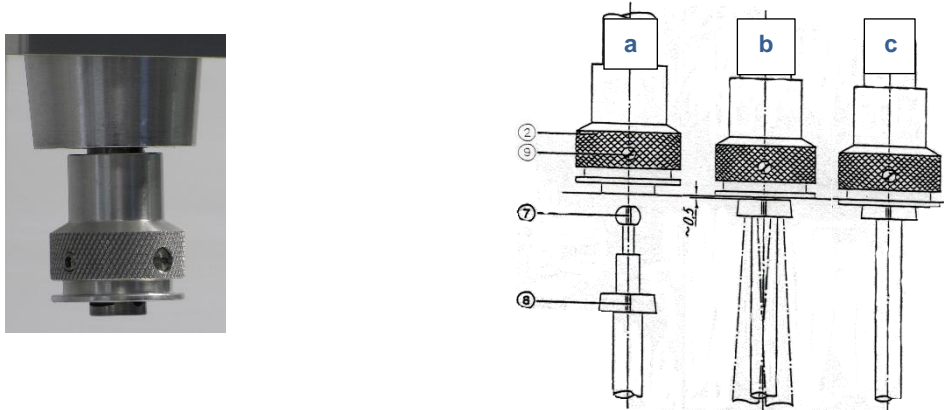

The fixing knurled sleeve (2) command the coupling. It moves vertically and it has 3 positions. In the Upper position (-a-), coupling is open and it enables to place and remove the measuring axis ball ending. When the placement of ball ending, please verify that training slots (7) (or identification marks of measuring bob (8)) are in front of the big screw (9) of fixing sleeve. In medium position (-b-), coupling is closed, but measuring bob axis (8) is handling free (Unlocked Position). In Lower position (-c-), Measuring bob axis (8) is strongly fixed (Locked Position).

Then device gets bayonet coupling, it will be compatible with all laboratory measuring system. Following part of the manual only cover this using.

As the instrument get only one kind of bayonet coupling system, way to install measuring bob on shaft of instrument is always the same.

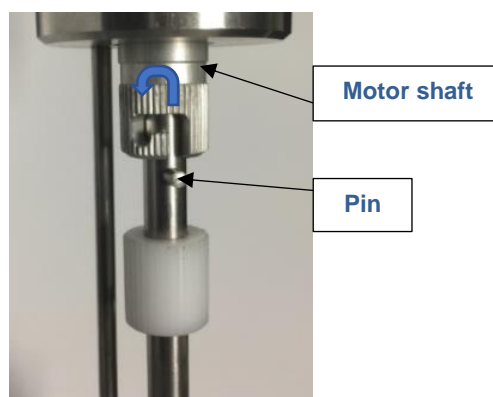

3.2 MS RV/LV (GuardLeg)

Measuring spindles according to ASTM / ISO 2555 (316L stainless steel).

These systems are ideally suited for simple viscosity measurement at controlled rotational speed in all areas of activity. The standard recommends use of 600ml beaker for measurement.

Here below are all available mobiles:

Name	Part number	Dim. (mm)	
LV-1 spindle	111010	Ø 18,80 - L 65,1	
LV-2 spindle	111011	Ø 18,72 - L 6,86	
LV-3 spindle	111012	Ø 12,60 - L 1,78	
LV-4 spindle	111013	Ø 3,20 - L 31	
Axis R 1-6 without disc	111000	Axe fileté	
RV-1 Disc	111001	Ø 56,26	
RV-2 Disc	111002	Ø 46,93	
RV-3 Disc	111003	Ø 34,69	
RV-4 Disc	111004	Ø 27,30	
RV-5 Disc	111005	Ø 21,14	
RV-6 Disc	111006	Ø 14,62	
RV-7 Spindle	111007	Ø 3,20	

The spindle L are delivered complete, while the R discs must be screwed on the R1-6 axis (Ref 111000).

These spindles are composed of two groups. The mobiles L are intended for low viscosity fluids and R mobiles for medium to high viscosities (see tables below):

Designation spindle	Part Number Spindle	Part Number Complete set**	Viscosity range Instrument LR (mPa.s)	Viscosity range B-ONE/FIRST/FIRST PRO/FIRST PRODIG (mPa.s)	Viscosity range RM100/RM200/DSR500 (mPa.s)	
RV1	111001*	11194 7	Not Usable	100 to 0.6M	50 to 1.4M	
RV2	111002*		11194 8	200 to 0.14M	200 to 2.4M	100 to 5.5M
RV3	111003*			300 to 0.37M	300 to 6M	150 to 14M
RV4	111004*			400 to 0.74M	600 to 12M	200 to 28M
RV5	111005*			500 to 1.4M	1.2K to 24M	300 to 55M
RV6	111006*			1200 to 3.7M	2.8K to 60M	500 to 130M
RV7	111007			4500 to 15M	12K to 240M	2K to 550M
LV1	111010	111014	15 to 0.25M	200 to 4.3M	35 to 10M	
LV2	111011		50 to 1.3M	1K to 20M	170 to 50M	
LV3	111012		200 to 5M	4k to 82M	650 to 190M	
LV4	111013		1000 to 22M	17K to 370M	3K to 860M	

M for millions, K for thousand

a) Need additional axis (PN111000)

b) Complete set (delivered with axis PN 111000 only for RV spindle)

When measuring, it is strongly recommended to heat the 600ml beaker. You can use either a thermostatic bath or the EVA LR PLUS temperature control system.

Place the instrument on its support (see section 1.5). Fill the beaker with 500 ml of product to be tested, taking care not to introduce air bubbles.

Place it in a bath (if you have one) for a sufficient time to reach the desired temperature.

If the product contains volatile or hygroscopic material, cover the beaker for the duration of the operation.

Place the measuring head in the highest position (use screw on aluminium arm as wrote in section 1.2).

Install RV or LV Guardleg as pictures show below (these items are optional).



Make a zero of your instrument (see section 2.5.) if you are using standard model.

Insert the measuring system with the bayonet coupling in the motor shaft (see section 3.1).

Use handle to manipulate the device on standard stand (see section 1.2), use screw on aluminium arm and go down to immerse the mobile in the product. With device on Rack stand, just turn screw to move down the measuring head. Beware of air bubbles under the disk!



Standard Stand



Rack Stand

Adjust the position of the instrument in the sample to immerse the mobile to the predefined mark (the lowest for discs # 2 -6, the highest for disc # 1), so as to immerse the Pt100 probe at least 3 mm (only for models equipped with a temperature probe integrated into the measuring head. If an external temperature sensor is used, the liquid level must always be in the mark on the axis mobile). Be careful that the tip of the mobile is 10 mm or more from the bottom of the beaker.



When the measurement height is optimum, use screw on arm to block height of measuring head when you are using standard stand. After you can use the stop ring on the support rod to memorize the position. With rack stand, you don't need to lock position and stop ring is not provided.



Wait until the temperature of the sample is within the prescribed limits (if you have temperature probe with your device).

Start the measurement at the desired speed and after choose the right measuring system (see section 2.3).

The torque measurement is indicated on the instrument screen using a gage. Ensure that the measured torque is always sufficiently far from the lower and upper limits (at least 5% above and below). If this is not the case, you can either change the measuring spindle or change the rotating speed.

Then your measurement is finished, raise the measuring head and lock it with screw on aluminium arm as wrote in section 1.2. Remove the measuring spindle to clean it.

3.3 MS BV

Measuring spindle for 150ml beaker (316L stainless steel).

These spindles are ideally suited for simple viscosity measurement at a rotating speed in control in all areas of activity. They are appreciated for their ease of use and the low volume of product needed compared to the MS RV/LV spindles.

Here below are all available spindle:

	Name	Part number	Dim. (mm)
	BV 1-100 Axis	117102	-
	BV centring device	117202	-
	BV Disc n°1	117001	Ø 45
	BV Disc n°10	117010	Ø 40
	BV Disc n°100	117100	Ø 20
	BV 1000 Axis	117101	Ø 4

This spindle allow measurement of huge viscosity range as showing below.

Designation spindle	Part Number Spindle ^{b)}	Part Number Complete set ^{c)}	Viscosity range B-ONE/FIRST/FIRST PRO/FIRST PRODIG (mPa.s)	Viscosity range RM100/RM200/DSR500 (mPa.s)
BV1	117001 ^{a)}	117000	15 to 0.25M	2 to 0.6M
BV10	117010 ^{a)}		100 to 2M	17 to 5.1M
BV100	117100 ^{a)}		1K to 22M	170 to 51M
BV1000	117101		10K to 220M	1.7K to 510M

M for millions, K for thousand

Use specific glass Beaker (PN117150 for 10pcs) or specific plastic beaker (PN117155 for 10 pcs).

a) Need additional axis (PN 117102)

b) Need to be used with Centring piece (PN 117202)

c) Complete set delivered with axis (PN117102) and centring tool (PN 117202)

The BV 1000 Axis can be used like this. But for BV Disc 1, 10 and 100, you should screw it on BV 1-100 Axis.

When measuring, it is strongly recommended to heat the 150ml beaker. You can use either a thermostatic bath or the EVA BV PLUS temperature control system.

Place the instrument on its support (see section 1.5). Fill the beaker with 120 ml of product to be tested, taking care not to introduce air bubbles.

Place it in a bath (if you have one) for a sufficient time to reach the desired temperature.

If the product contains volatile or hygroscopic material, cover the beaker for the duration of the operation.

Place the measuring head in the highest position (use screw on aluminium arm as wrote in section 1.2).

Make a zero of your instrument (see section 2.5) if you are using standard model.

Insert the measuring system with the bayonet coupling in the motor shaft (see section 3.1).

Use handle to manipulate the device on standard stand (see picture section 3.2), use screw on aluminium arm and go down to immerse the mobile in the product. With device on Rack stand, just turn screw to move down the measuring head. Beware of air bubbles under the disk!

Adjust the position of the instrument in the sample to immerse the mobile to the predefined mark. Be careful that the tip of the mobile is 10 mm or more from the bottom of the beaker.



When the measurement height is optimum, use screw on arm to block height of measuring head when you are using standard stand. After you can use the stop ring on the support rod to memorize the position. With rack stand, you don't need to lock position and stop ring is not provided (see picture on section 3.2).

Wait until the temperature of the sample is within the prescribed limits.

Start the measurement at the desired speed and after choose the right measuring system (see section 2.3).

The torque measurement is indicated on the instrument screen using a gage. Ensure that the measured torque is always sufficiently far from the lower and upper limits (at least 5% above and below). If this is not the case, you can either change the measuring spindle or change the measurement speed.

Then your measurement is finished, raise the measuring head and lock it with screw on aluminium arm as wrote in section 1.2. Remove the measuring spindle to clean it.

3.4 MS VANE

Measuring spindles with blades (316L stainless steel).

These systems are ideal for viscosity measurement (value or curve) in control or development of all types of products even of very high viscosity with or without particles (size <5mm). They can be used for direct measurement in user's containers.



4 blades VANES



6 Blades VANE

All data given in table next page are given for information and can be changed according container use for measurement. For example, shear rate range show same data as for speed range of instrument. And most of the time, you will be able to use only speed for your viscosity measurement and not the shear rate.

Here below are all available spindles with viscosity range (in mPa.s):

Designation	Part Number	Diameter (mm)	Length (mm)	Viscosity range LR Device (mPa.s)	Viscosity range B-ONE/FIRST/FIRST PRO/FIRST PRODIG (mPa.s)	Viscosity range RM100/RM200/DSR500 (mPa.s)
MK-V71	111114	34,39	68,78	1,4 to 18K	14 to 300K	2,4 to 700K
MK-V72**	120017	21,67	43,38	5,6 to 74K	56 to 1,2M	9,4 to 2,8M
MK-V73**	111108	12,67	25,35	28 to 370K	280 to 6M	46 to 13M
MK-V74**	111115	5,89	11,76	280 to 3,7M	2,8K to 60M	463 to 139M
MK-V75**	111111	8,026	16,05	111 to 1,4M	1,1K to 24M	185 to 55M
MK-V72/2**	111112	21,67	20	54 to 720K	540 to 11M	90 to 27M
MK-V72/4**	111113	21,67	10	80 to 1M	800 to 17M	133 to 40M
MK-V72-6P*	111121	21,67	43	30 to 400K	300 to 6,5M	50 to 15M
MK-VT105**	440105	5	10	430 to 5,8M	4,4K to 94M	726 to 218M
MK-VT2010**	442010	10	20	82 to 1M	820 to 17M	137 to 41M
MK-VT2020**	442020	20	20	12 to 150K	118 to 2,5M	20 to 5,9M
MK-VT3015**	443015	15	30	16 to 210K	160 to 3,4M	27 to 8M
MK-VT4020**	444020	20	40	7 to 90K	68 to 1,4M	11 to 3,4M
MK-VT4040	444040	40	40	1,5 to 19K	15 to 320K	2,5 to 740K
MK-VT5025**	445025	25	50	4 to 45K	34 to 730K	6 to 1,7M
MK-VT6015	446015	15	60	9 to 114K	86 to 1,8M	15 to 4,3M
MK-VT6030	446030	30	60	2 to 26K	20 to 433K	3,5 to 1M
MK-VT608	446008	8	60	30 to 400K	300 to 6,5M	50 to 15M
MK-VT8040	448040	40	80	1 to 11K	9 to 182K	2 to 420K
MK-VT8070	448070	70	80	0,5 to 3,2K	3 to 52K	1 to 120K

M for million, K for thousand

* VANE 6 BLADES.

** These items can be used with tube MB-DIN1 (P.N.112932).

All data given in this table are given for information and can be changed according container use for measurement. For example, shear rate range show same data as for speed range of instrument. And most of the time, you will be able to use only speed for your viscosity measurement and not the shear rate.

Place the instrument on its support (see section 1.5).

Place the measuring head in the highest position (use screw on aluminium arm as wrote in section 1.2).

Make a zero of your instrument (see section 2.5) if you are using standard model.

Insert the measuring system with the bayonet coupling in the motor shaft (see section 3.1).

For the use of these measuring systems, you can use 600 ml or 150 ml beaker or your own container.

Fill your beaker or container. Use handle to manipulate the device on standard stand (see picture section 3.2), use screw on aluminium arm and go down to immerge the mobile in the product. With device on Rack stand, just turn screw to move down the measuring head.

Adjust the position of the instrument to immerge the measuring system in the sample (only part with blade) and not to close from the bottom of beaker (minimum distance should be 10mm). When the measurement height is optimum,

use screw on arm to block height of measuring head when you are using standard stand. After you can use the stop ring on the support rod to memorize the position. With rack stand, you don't need to lock position and stop ring is not provided (see picture on section 3.2).

Start the measurement at the desired speed and after choose the right measuring system (see section 2.3). If your Vane measuring system is not in the list, please refer to section 2.6.6 to create it.



The torque measurement is indicated on the instrument screen using a gage. Ensure that the measured torque is always sufficiently far from the lower and upper limits (at least 5% above and below). If this is not the case, you can either change the measuring spindle or change the measurement speed.

Then your measurement is finished, raise the measuring head and lock it with screw on aluminium arm as wrote in section 1.2. Remove the measuring spindle to clean it.

3.5 MS KREBS

Krebs type measuring spindles compatible with ASTM D562 standard (316L stainless steel). These systems are ideal for viscosity measurement in Krebs units in control of all types of products. They can be used for direct measurement in user containers or in 600 or 150ml beakers.

Here below are all available spindle:

Name	Part number	Dim. (mm)	
MK-KU 1-10	111100	L. 54,11	
MK-75Y	111103	L. 34,58	

For your information, only MK-KU1-10 is compliant with norm ASTM D562.

To get KU unit for your viscosity measurement with your instrument, you must choose the measuring spindle MK-KU1-10 and speed at 200 rpm. For all other speed and measuring spindle, you will get viscosity value in Pa.s.

Range for these spindles is (for LR on demand):

- MK KU1-10: 20-500mPa.s and 40-140KU (at 200 rpm).
- MK-75Y: 100-50000 mPa.s.

Place the instrument on its support (see section 1.5).

Place the measuring head in the highest position (use screw on aluminium arm as wrote in section 1.2).

Make a zero of your instrument (see section 2.5.) if you are using standard model.

Insert the measuring system with the bayonet coupling in the motor shaft (see section 3.1).

For the use of these measuring system, you can use 600ml or 150 ml beaker or your own container. Fill your beaker or container.

Use handle to manipulate the device on standard stand (see picture section 3.2), use screw on aluminium arm and go down to immerge the mobile in the product. With device on Rack stand, just turn screw to move down the measuring head.

Adjust the position of the instrument to immerge the measuring system in the sample (only part with blade) and not to close from the bottom of beaker (minimum distance should be 10mm). Be careful that the tip of the mobile is 10 mm or more from the bottom of the beaker.

When the measurement height is optimum, use screw on arm to block height of measuring head when you are using standard stand. After you can use the stop ring on the support rod to memorize the position. With rack stand, you don't need to lock position and stop ring is not provided (see picture on section 3.2).

Start the measurement at the desired speed and after choose the right measuring system (see section 2.3). If your Vane measuring system is not in the list, please refer to section 2.6.6 to create it.

The torque measurement is indicated on the instrument screen using a gage. Ensure that the measured torque is always sufficiently far from the lower and upper limits (at least 5% above and below). If this is not the case, you can either change the measuring spindle or change the measurement speed.

Then your measurement is finished, raise the measuring head and lock it with screw on aluminium arm as wrote in section 1.2 Remove the measuring spindle to clean it.













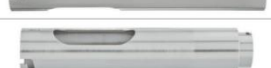

3.6 MS DIN

Coaxial cylinders measuring systems according to DIN / ISO 3219 (316L stainless steel).

These systems make it possible to set the shear rate in order to carry out viscosity measurements or to obtain curves to study flow behaviour, yield stress or thixotropy.

They are particularly suitable for the control or development of homogeneous products with liquid aspect and with or without particles (size <200µm).

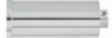
Please find below MS DIN items.

Name	Reference	
MK - DIN 1	112820	
MK - DIN 2	112821	
MK - DIN 3	112822	
MK - DIN 9	111875	
MB-DIN 1 Tube	112932	
MB-DIN 2 Tube	112937	
MB-DIN 3 Tube	112938	
CAP-DIN 1	112872	
CAP-DIN 2	112877	
CAP-DIN 3	112878	
CAP-DIN 1 Mooney	112874	
ST-R centring tool	114436	
MB-DIN 1 S Tube	112933	
MB-DIN 2 S Tube	112948	
MB-DIN 3 S Tube	112944	

Complete configurations include a DIN tube or DIN XS tube, a MK-DIN cylinder and a cap.

Measuring system		Spindle	Cup	Cap	Category
Designation	Part Number	Designation	Designation	Designation	
MS DIN 11	112801	MK-DIN1	MB-DIN1	CAP-DIN1	A
MS DIN 11 S	112809	MK-DIN1	MB-DIN1S	CAP-DIN1	B
MS DIN 12	112802	MK-DIN2	MB-DIN1	CAP-DIN1	A
MS DIN 13	112803	MK-DIN3	MB-DIN1	CAP-DIN1	A
MS DIN 13S	112808	MK-DIN3	MB-DIN1S	CAP-DIN1	B
MS DIN 19	112806	MK-DIN9	MB-DIN1	CAP-DIN1	A
MS DIN 22	112804	MK-DIN2	MB-DIN2	CAP-DIN2	A
MS DIN 22S	112815	MK-DIN2	MB-DIN2S	CAP-DIN2	B
MS DIN 33	112805	MK-DIN3	MB-DIN3	CAP-DIN3	A
MS DIN 33S	112814	MK-DIN3	MB-DIN3S	CAP-DIN3	B
MS DIN 11M	112812	MK-DIN1	MB-DIN1	CAP-MOONEY	A
MS DIN 19M	112811	MK-DIN9	MB-DIN1	CAP-MOONEY	A
MS DIN 23	112816	MK-DIN3	MB-DIN2	CAP-DIN2	A

Here are the measuring ranges (viscosity in mPa.s **) of the existing MS DIN measuring systems:

Measuring system * Designation	Volume (ml)	Shear rate (s ⁻¹)**	Viscosity range LR Device (mPa.s)	Viscosity range B-ONE/FIRST/FIRST PRO/FIRST PRODIG (mPa.s)	Viscosity range RM100/RM200/DSR500 (mPa.s)
MS DIN 11	27	1,29N	2,5 to 27K	25 to 0.44M	3 to 1M
MS DIN 11 S	27	1,29N	2,5 to 27K	25 to 0.44M	3 to 1M
MS DIN 12	46	0,35N	11 to 145K	110 to 2.3M	18 to 5.5M
MS DIN 13	61	0,15N	92 to 510K	920 to 8.3M	146 to 19M
MS DIN 13S	22	0,15N	93 to 510K	920 to 8.3M	146 to 19M
MS DIN 19	25	3,22N	0,8 to 10K	8 to 0.17M	1 to 0.39M
MS DIN 22	22	1,29N	4 to 53K	40 to 0.86M	7 to 2M
MS DIN 22S	22	1,29N	5 to 53K	40 to 0.86M	7 to 2M
MS DIN 33	14	1,29N	20 to 265K	200 to 4.3M	34 to 10M
MS DIN 33S	14	1,29N	20 to 265K	200 to 4.3M	34 to 10M
MS DIN 11M	23	1,29N	2,5 to 27K	21 to 0.44M	3 to 1M
MS DIN 19M	18,5	3,22N	0,8 to 10K	8 to 0.17M	1 to 0.39M
MS DIN 23	36	0,19N	81 to 1M	810 to 17M	139 to 41M

M for million, K for thousand, N for rotational speed (rpm)

* Complete measuring system with spindle, cup and cap.

** These values are given when complete system is used.

*** Include centring tool ST-R (P.N. 114436).

3.6.1 Use of category A (MS-DIN)

Each tube is used with the matching cylinder (e.g. DIN tube 1 with cylinder MK-DIN1). The cylinder MK-DIN 9 is used with the DIN tube 1. The tubes can be closed with their cap assorted or used open for a measurement immersed in a container containing the liquid to be measured. The Mooney plug is used exclusively with the DIN 1 tube and the MK-DIN 1 and MK-DIN 9 cylinders. It reduces the volume of product required for the measurement (see table on section 3.6).

In addition to these measuring systems, a DIN X tube with a MK-DIN X + 1 cylinder can be used. Thus, MS DIN 12, MS DIN 13 and MS DIN 23 measuring systems can also be used. The first digit always indicates the number of the tube and the second digit the number of the cylinder MK. There is also a measuring system MS DIN 19 which uses the DIN tube 1 and MK-DIN 9 cylinder.

All systems shown above can be used with or without a temperature control unit since the tube attaches to the base of the instrument (see below). When your instrument is combined with an EVA MS DIN, EVA MS DIN-MSR, EVA 100, RT1, CT DIN or CT-LC temperature setting unit, the positioning of the measuring cylinders and tubes is the same. It will be necessary to introduce the assembly into the temperature chamber.

The first step is to install the cap on the tube as shown in the picture below (not necessary if you make a dip measurement directly into a pot). Also check that the gasket is properly installed on the cap. The first insertion of the cap can be difficult. You must use some silicone grease to facilitate installation.

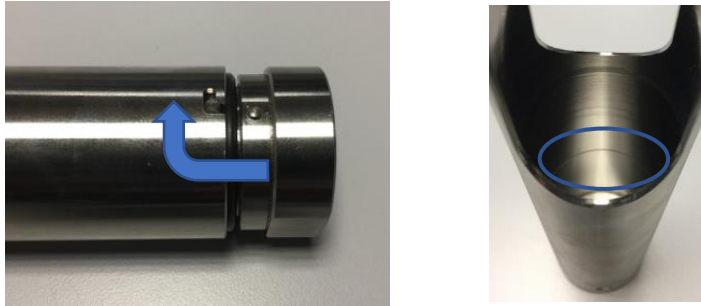

You can then put the product to be measured in the tube. The necessary volume is indicated in the table on the previous page according to the system used. There is a level line in the tube (see picture).

Place the instrument on temperature unit or on its own stand if you are using CT-DIN or CT-LC. Place the measuring head in the highest position (use screw on aluminium arm as wrote in section 1.2).

Make a zero of your instrument (see section 2.5) if you are using standard model.

Insert the measuring system with the bayonet coupling in the motor shaft (see section 3.1).

You can then introduce the MS DIN tube with the product from the bottom up slowly and making sure to align with the cylinder. Also place the groove on the tube facing you as shown in the picture below). When you are close enough to the instrument basis, you must rotate the tube to place the pin in the groove of the tube.

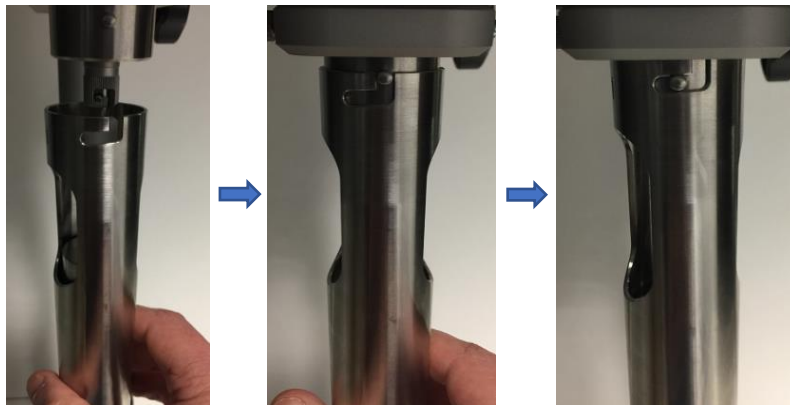

Once the tube is properly installed, check that the temperature sensor (if your device gets one) on the instrument is at least 3mm deep into the liquid.

When using your instrument with a temperature control system (EVA MS DIN, EVA MS DIN MSR, EVA 100, CT DIN or RT-1), you must then lower the measuring head in such a way that the tube comes inside the hole provided for this purpose. Check that there is no product on the outer wall of the tube.

Use the arm handle and screw (see section 1.2) to gently lower the measuring head. The tube should be easily housed in the chamber. If this is not the case, do not force it and contact your local distributor or LAMY RHEOLOGY.

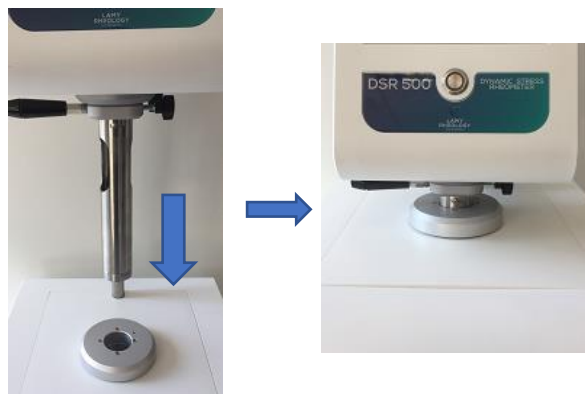

When the measuring head is properly positioned, there is no need to lock the position using the screw on the stem. Also, be sure to allow sufficient time for stabilization if the measurement temperature is different from the ambient temperature (at least 10 minutes) before making your measurement.

When using MS DIN measuring systems for immersion measurement, the order and method of installation is the same for cylinder and tube. Since there is no cap on the tube, you will need to put the product to be measured in a pot larger than the tube.

Then lower the measuring head by using the handle and the screw on the arm (see section 1.2) so that the tube is immersed in the pot and the temperature probe (if your device gets one) is sufficiently immersed in the liquid (at least 1 cm). Take care that the liquid level never exceeds the level of the white ring present on the cylinder axis MK DIN. You must use the screw on the arm (see section 1.2) to block the measuring position and take care that there is enough space between the tube and the bottom of the pot for the liquid to rise in the tube.



Once the setup is complete, you can do your measurement (see section 2.3).

If you have just made a measurement with the tube closed by a cap, rise the measuring head to the highest position by blocking the arm with the screw provided for this purpose (see section 1.2). Carefully remove the cylinder from the instrument shaft, then remove the tube containing the product and the cylinder, being careful if the temperature is high. You can then remove the MK DIN cylinder from the DIN tube for cleaning. Remove the DIN tube cap to clean it. Remember to clean the temperature probe (if present).

If you have just made a measurement in immersion (without cap), it is preferable to remove the cylinder from the axis of the motor and after the tube from the base of the instrument before rise the measuring head. You can then take the tube and cylinder for cleaning. Remember to clean the temperature probe (if present).

3.6.2 Use of category B (MS-DIN" S")

There are also other DIN x S type tubes that are used with EVA MS DIN, EVA MS DIN-MSR, EVA 100, RT1, CT DIN or CT-LC temperature units.

DIN xS tubes are used with the same MK-DIN cylinders and caps as standard DIN tubes. The measuring ranges are therefore unchanged (see table section 3.6). Their using facilitates cleaning and filling since they are shorter and therefore easier to access. On the other hand, they require the use of an accessory (Ref 114436) which guarantees a perfect centering of the cylinder in the tube.

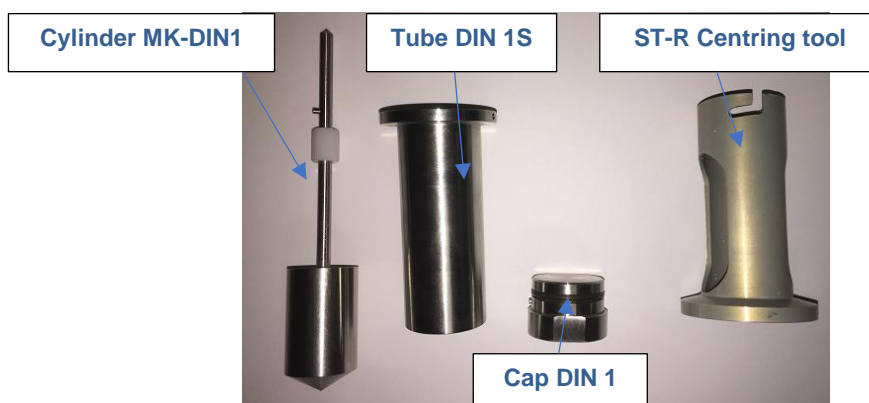

The first step is to install the cap on the tube as shown in the photo below. Also check that the gasket is properly installed on the cap. The first insertion of the cap can be difficult. You must use some silicone grease to facilitate installation.

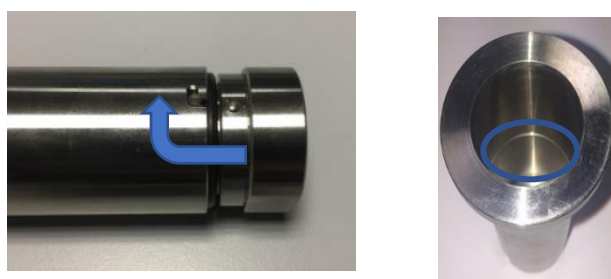

You can then put the product to be measured in the cylinder. The necessary volume is indicated in the table section 3.6 according to the system used. There is a level line in the tube (see picture below).

Place the instrument on temperature unit or on its own stand if you are using CT-DIN or CT-LC. Place the measuring head in the highest position (use screw on aluminium arm as wrote in section 1.2).

You must then install the centring piece on the base of the instrument. Also place the groove facing you as shown in the picture below. When you are close enough to the instrument basis, you must rotate the piece to place the pin in the groove.



Make a zero of your instrument (see section 2.5) if you are using standard model.

Insert the measuring system with the bayonet coupling in the motor shaft (see section 3.1).

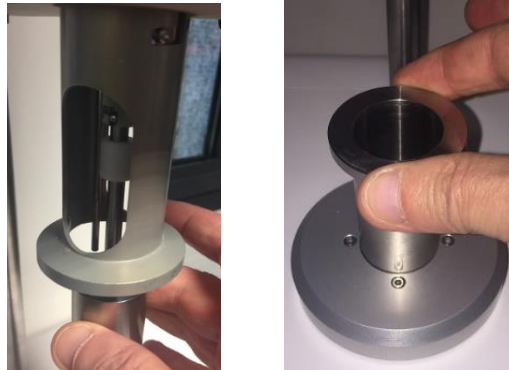

Put the tube with your product inside the warming unit.

Use the arm handle and screw (see section 1.2) to gently lower the measuring head. The centring piece must completely cover the rim of the tube.

When the measuring head is properly positioned, there is no need to lock the position using the screw on the arm. Also, be sure to allow sufficient time for stabilization if the measurement temperature is different from the ambient temperature (at least 10 minutes) before making your measurement.



Once the setup is complete, you can do your measurement (see section 2.3).

When your measurement is complete, it is better to remove the cylinder from the instrument shaft. That will rest in the tube. Rise the measuring head to the highest position by blocking the arm with the screw provided (see section 1.2). Then remove the tube containing the product and the cylinder, being careful if the temperature is high. You can then remove the MK DIN cylinder from the tube for cleaning. Remove the DIN tube cap to clean it. Don't forget to clean the temperature probe (if available).

3.7 MS SV (Thermocell and Small Volume Package)

Measuring systems for low volumes (316L stainless steel).

This section explain also how to use THERMOCELL and Small volume package.

These systems, unlike the MS-RV/LV and MS-DIN systems, make it possible to measure products in small quantities by applying a shear rate up to temperatures of 300°C (according to models, see table). With RT-1 and THERMOCELL package, these systems are compatible with ASTM D3236 and D4402.

Here are the available accessories:

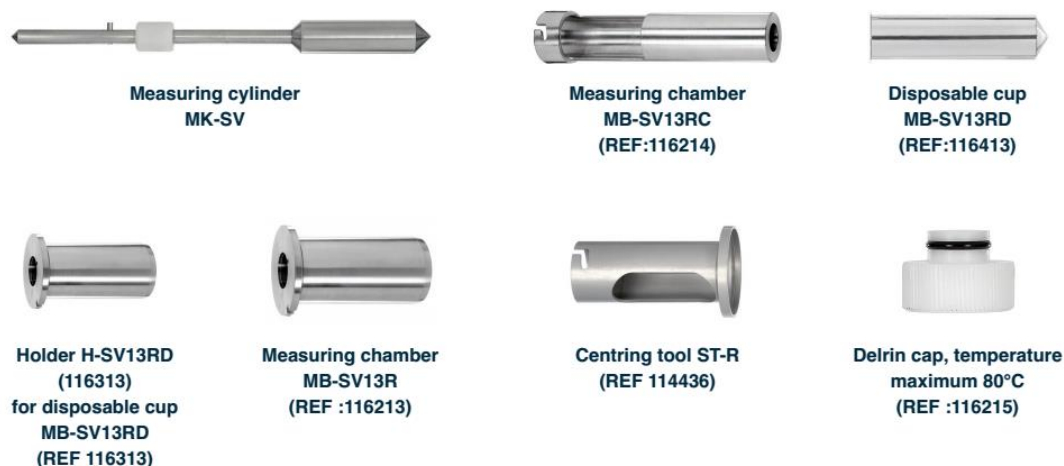

Please find below all item as MK-SV spindle and MB-SV chamber with viscosity range (mPa.s):

Measuring Cylinder		Compatible chamber****		Volume (ml)	Shear rate (s ⁻¹)	Viscosity range LR Device (mPa.s)	Viscosity range B-ONE/FIRST/FIRST PRO/FIRST PRODIG (mPa.s)	Viscosity range RM100/RM200/DSR500 (mPa.s)
Designation	Item	Designation	Item					
MK-SV414*	116114	MB-SV6R*	116206	3	0,4N	44 to 5,8M	440 to 95M	73 to 219M
MK-SV415*	116115	MB-SV7R*	116207	4,4	0,48N	15 to 2M	155 to 33M	26 to 77M
MK-SV416*	116116	MB-SV8R*	116208	4,6	0,29N	39 to 5,2M	394 to 85M	66 to 197M
MK-SV418	116118	MB-SV13R MB-SV13RC** MB-SVD***	116213 116214 116513	7,5	1,32N	1 to 120K	9 to 1,9M	2 to 4,5M
MK-SV421	116121			8	0,93N	1 to 188K	14 to 3M	2 to 7M
MK-SV425	116125			10	0,22N	174 to 23M	1,7K to 377M	291 to 870M
MK-SV427	116127			12	0,34N	7 to 0,99M	75 to 16M	12 to 37M
MK-SV428	116128			13	0,28N	15 to 1,9M	147 to 31M	24 to 73M
MK-SV429	116129			13	0,25N	29 to 3,9M	294 to 63M	49 to 146M
MK-SV431	116131			11	0,34N	10 to 1,3M	100 to 21M	16 to 49M
MK-SV434	116134			11	0,28N	19 to 2,5M	194 to 41M	32 to 96M
MK-SVC	116002			13	0,43N	3 to 420K	32 to 6,8M	5 to 15M
MK-SVTR8	140008			8	0,92N	1 to 190K	14 to 3M	2 to 7M
MK-SVTR9	140009			12	0,34N	7 to 0,99M	75 to 16M	12 to 37M
MK-SVTR10	140010			13	0,28N	15 to 1,9M	146 to 31M	24 to 72M
MK-SVTR11	140011			13	0,25N	30 to 3,9M	300 to 64M	50 to 149M

M for million, K for thousand, N for rotational speed (rpm).

* Not compatible with RT-1 PLUS THERMOCELL PACKAGE.

** This cup can be used without centring tool ST-R. Need CAP 116215. Temperature max 80°C.

*** This item include 100 disposable cup MB-SV13RD (116413) and holder H-SVRD (116313).

**** These items need centring tool ST-R (item 114436 include with THERMOCELL and SVP65/180).

Measuring cylinder can be used with different chambers and can be categorized as below:

- Category A: Spindle used with chamber MB-SVD.
- Category B: Spindle used with chamber MB-SV13R, MB-SV6R, MB-SV7R and MB-SV8R.
- Category C: Spindle used with chamber MB-SV13RC.

Measuring systems of category A can only be used with temperature controllers EVA DIN, EVA DIN MS-R, RT-1 PLUS and water jacket CT-LC and CT DIN. They come with disposable cups (a batch of 100) ideal for measuring on aggressive or difficult to clean products.

Measuring systems of category B can only be used with temperature controllers EVA DIN, EVA DIN MS-R, RT-1 PLUS and water jacket CT-LC and CT DIN. They come with a reusable stainless steel measuring cup.

The measuring systems in category C can be used alone or with temperature controllers EVA DIN, EVA DIN MS-R and water jacket CT-LC and CT DIN. Temperature max will be 80°C. They come with a measuring cup in stainless steel and Delrin cap.

3.7.1 MS-SV with Chamber MB-SVD (Thermocell)

Whatever the measurement system model, the using is the same.

If you have temperature unit as RT-1 PLUS or EVA MS-DIN, the measuring head must first be installed on the heating unit (see installation instructions supplied with the temperature control). If you are using water jacket CT-LC or CT-DIN, please place it below instrument installed on its own stand.

The first step is to place the screw on the centring piece (ST-R) and then install the latter on the base of the instrument.

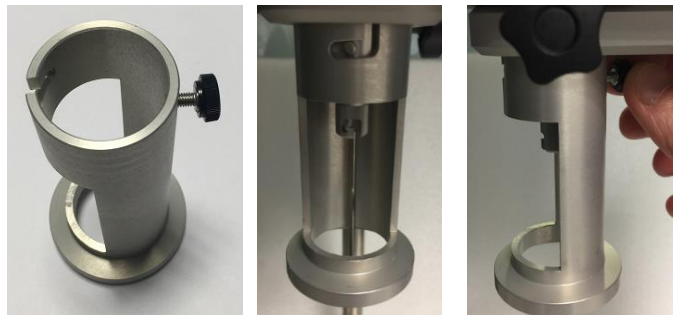

The screw locks the centring piece on the base of the instrument.

Make a zero of your instrument (see section 2.5) if you are using standard model.

Insert the measuring system with the bayonet coupling in the motor shaft (see section 3.1).



Place the disposable cup holder H-SV13RD in well of the temperature control.

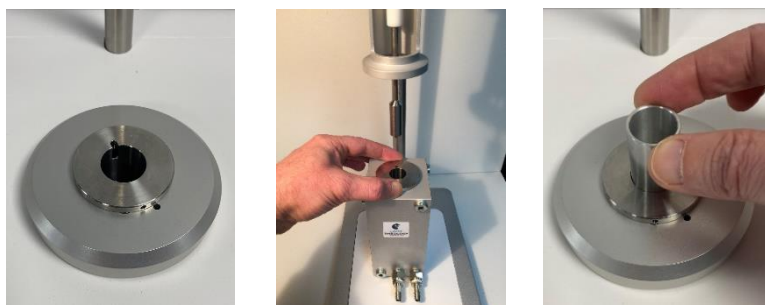

Take a disposable cup MB-SV13RD, fill it with your product (see table section 3.7 for the volume of product to be put into the measurement system). Then place it in the disposable cup holder. Turn it so that the notch at the bottom fits snugly into the bottom of the disposable cup holder.

Use handle and screw of arm (see section 1.2) to gently lower the measuring head. Take care of the Pt100 (if you have one on device) and be sure that it will fit correctly hole of cup. The centring piece must completely cover the edge of the disposable cup insert.



When the measuring head is properly positioned, there is no need to lock the position using the screw on the arm. Also, be sure to allow sufficient time for stabilization if the measurement temperature is different from the room temperature (at least 10 minutes) before taking your measurement.

You can do your measurement (see section 2.3).

Once the measurement is complete, unhook the mobile from the instrument axis and rise the measuring head. Remove the spindle to clean it.



Remove the holder with the disposable cup by using special tool provide for that operation (provided with Thermocell package). Place holder with disposable cup inside on flat table. Disposable cup will move up from holder. Also clean the temperature probe and the centring piece. It can stay in place on the basis of the instrument for a next measurement.

3.7.2 MS-SV with chamber MB-SV13R (Thermocell and SVP65/180)

Whatever the measurement system model, the using is the same.

If you have temperature unit as RT-1 PLUS or EVA MS-DIN, the measuring head must first be installed on the heating unit (see installation instructions supplied with the temperature control). If you are using water jacket CT-LC or CT-DIN, please place it below instrument installed on its own stand.

The first step is to place the screw on the centring piece (ST-R) and then install the latter on the base of the instrument.



The screw locks the centring piece on the base of the instrument.

Make a zero of your instrument (see section 2.5) if you are using standard model.

Insert the measuring system with the bayonet coupling in the motor shaft (see section 3.1).



You can then put the product to be measured in the cup MB-SVXR. The required volume is indicated in the table in section 3.7 according to the system used.

Install MB-SVXR chamber on the well of temperature unit or water jacket as shown below.

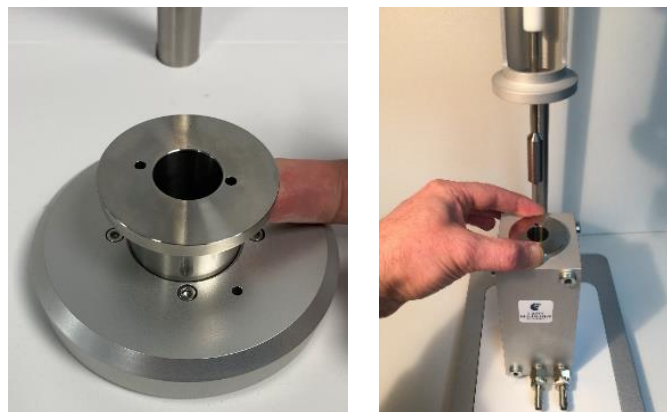

Use handle and screw of arm (see section 1.2) to gently lower the measuring head. Take care of the Pt100 (if you have one on device) and be sure that it will fit correctly hole of cup. The centring piece must completely cover the edge of the disposable cup insert.

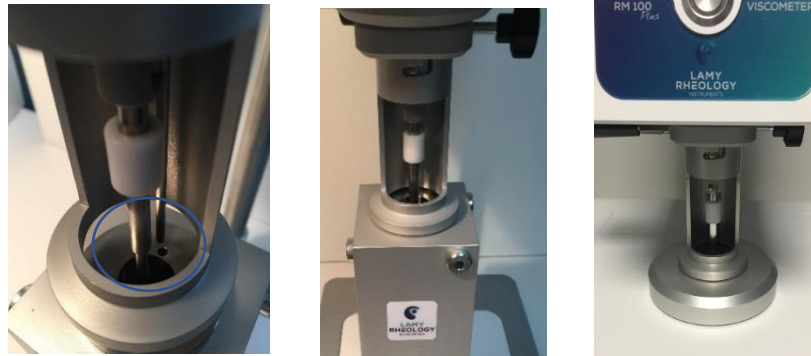

When the measuring head is properly positioned, there is no need to lock the position using the screw on the arm. Also, be sure to allow sufficient time for stabilization if the measurement temperature is different from the room temperature (at least 10 minutes) before taking your measurement.

If you are using immersion probe (Ref. 000696), this is time to install it as shown on picture below.

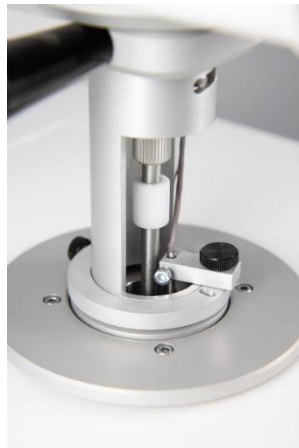

You can do your measurement (see section 2.3).

When your measurement is complete, it is recommended to remove the cylinder from the instrument shaft. It will rest in the tube. Rise the measuring head to the highest position by blocking the arm with the screw provided (see section 1.2). Remove the spindle to clean it.

Remove the cup by using special tool provide for that operation (provided with Thermocell). Also clean the temperature probe and the centring piece. It can stay in place on the basis of the instrument for a next measurement.



3.7.3 MS-SV with chamber MB-SV13RC

These systems can therefore be used with or without a heating unit (RT-1PLUS, DIN EVA and water jacket CT-DIN/CT-LC). The cup MB-SV13RC used for these systems is fixed directly to the base of the instrument.

Please note that maximum temperature with this system is 80°C.

If you have temperature unit as RT-1 PLUS or EVA MS-DIN, the measuring head must first be installed on the heating unit (see installation instructions supplied with the temperature control). If you are using water jacket CT-LC or CT-DIN, please place it below instrument installed on its own stand.

The first step is to install the Delrin cap on tube MB-SV13RC as shown in the photo below. Also check that the gasket is properly installed on the plug. The first insertion of the cap can be difficult. You must use some silicone grease to facilitate installation.

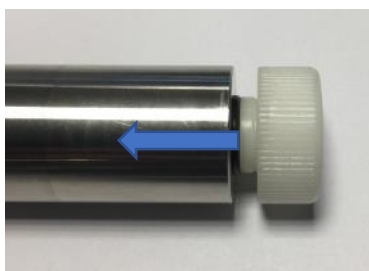

You can then put the product to be measured in the cup. The necessary volume is indicated in the table in section 3.7 according to the system used.

Make a zero of your instrument (see section 2.5) if you are using standard model.

Insert the measuring system with the bayonet coupling in the motor shaft (see section 3.1).

You can then present the tube with the product from the bottom up slowly and making sure to align with the cylinder. Also place the mark on the tube facing you as shown in the picture below). When you are close enough to the Instrument base, you must rotate the tube to place the pin in the mark of the tube.



Once the tube is properly installed, check that the temperature sensor (if you have one) on the instrument is at least one centimetre deep into the liquid.

When using your instrument with a temperature control system (EVA MS DIN or CT DIN), you must then lower the measuring head so that the tube fits into the chamber provided for this purpose. Check that there is no product on the outer wall of the tube.

Use the handle and screw on arm (see section 1.2) to gently lower the measuring head. The tube should be easily housed in the hole of temperature controller. If this is not the case, do not force it and contact your local distributor or LAMY RHEOLOGY.



When the measuring head is properly positioned, there is no need to lock the position using the screw on the stem. Also, be sure to allow sufficient time for stabilization if the measurement temperature is different from the room temperature (at least 10 minutes) before taking your measurement.

Once the setup is complete, you can do your measurement (see section 2.3).

When your measurement is complete, it is recommended to remove the cylinder from the instrument shaft. It will rest in the tube. Rise the measuring head to the highest position by blocking the stem with the screw provided (see section 1.2). Then remove the tube containing the product and the cylinder, take care if the temperature is high. You can then remove the cylinder from the tube to clean it. Remove the cap from the tube to clean it. Clean the temperature sensor.

3.8 T-Bars and Helipro Stand

The HELIPRO device makes it possible to measure viscosity of gels, pastes, creams and more generally products that do not flow.

When a measuring mobile turns in this type of product, we can observe appearance of cavities around the rotating spindle which has effect of reducing measured viscosity values. Through its movement vertical, HELIPRO system with its mobile T shape will prevent formation of cavities within product and will ensure reliable and consistent measurement.

This accessory is compatible with instruments and rheometers from the LAMY RHEOLOGY range except FIRST PRODIG CP 1000, RM 100 CP 1000/2000 PLUS, RM 200 CP 4000 PLUS, GT-300 PLUS, GT-300 PRODIG and DSR 500 CP 4000 PLUS.

THE HELIPRO SYSTEM is delivered with a box including 6 T-bar spindles and 1 adaptation to fix the spindles. It is also delivered with a Hex screw driver for adjust the lower and upper switch limits of the up and down moving, one handle and button already installed on arm.

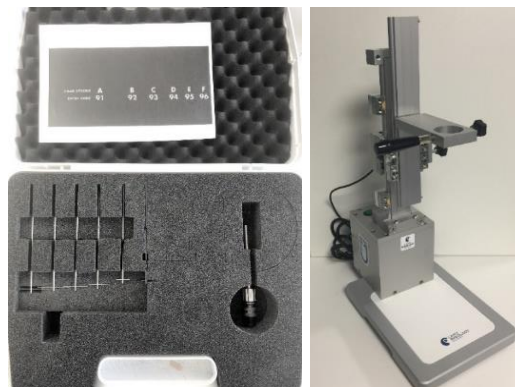

You can find below measuring range for each T-Bars provide with HELIPRO STAND.

Designation T-Bars**	Part number	Viscosity range LR Device (mPa.s)		Viscosity range B-ONE/FIRST/FIRST PRO/FIRST PRODIG (mPa.s)		Viscosity range RM100/RM200/DSR500 (mPa.s)	
		Minimum	Maximum	Minimum	Maximum	Minimum	Maximum
T-A (91)	18091	93	740K	930	12M	930	28M
T-B (92)	18092	186	1.5M	1,9K	25M	1,9K	56M
T-C (93)	18093	464	3.7M	4,6K	60M	4,6K	140M
T-D (94)	18094	1K	7.5M	9,2K	120M	9,2K	280M
T-E (95)	18095	1,9K	15M	18,6K	240M	18,6K	558M
T-F (96)	18096	4,6K	37M	46,4K	600M	46,4K	1400M

M for million, K for thousand

* Viscosity value done for speed range from 0,3 to 15 rpm.

** Included with HELIPRO package (P.N. 111015).

Install the instrument on the stand and fix it with the button. Take care of temperature probe if your device gets one. Insert the spindle inside chuck, lock it by screwing.

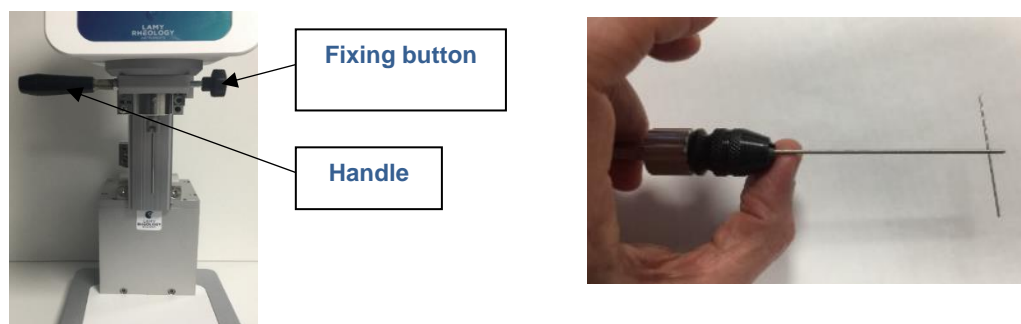

Make a zero of your instrument (see section 2.5) if you are using standard model.

Insert the measuring system with the bayonet coupling in the motor shaft (see section 3.1).



Place the container with product to be measured below and adjust position of measuring head so that spindle reaches desired position. A release button and handle help you lower the measuring head.

Adjust the position of the 2 limits switch up and down with the screw driver to fix path should be done by measuring head.

Press the button ON/OFF for starting the up and down movement. Helipro stand moves at speed 1 mm/s.

Start the measurement at the desired speed (15 rpm maximum) and choose the right measuring system (see section 2.3).

The torque measurement is indicated on the instrument screen using a gauge. Ensure that the measured torque is always sufficiently far from the lower and upper limits (at least 5% above and below). If this is not the case, you can either change the speed.

Then your measurement is finished, stop the movement of Helipro stand, raise the measuring head by using handle and release button and lock it in high position. Remove the measuring spindle to clean it.

3.9 MS-R

Anchor-type measuring systems (316L stainless steel).

These systems are ideally suited for measuring viscosity (value or curve) in the control or development of heterogeneous products, or having the appearance of soft solid at rest, present in cosmetics, paint, food or mineral chemistry industries.

Used with their respective cups, they allow to apply a shear rate.

This is the measuring systems available:

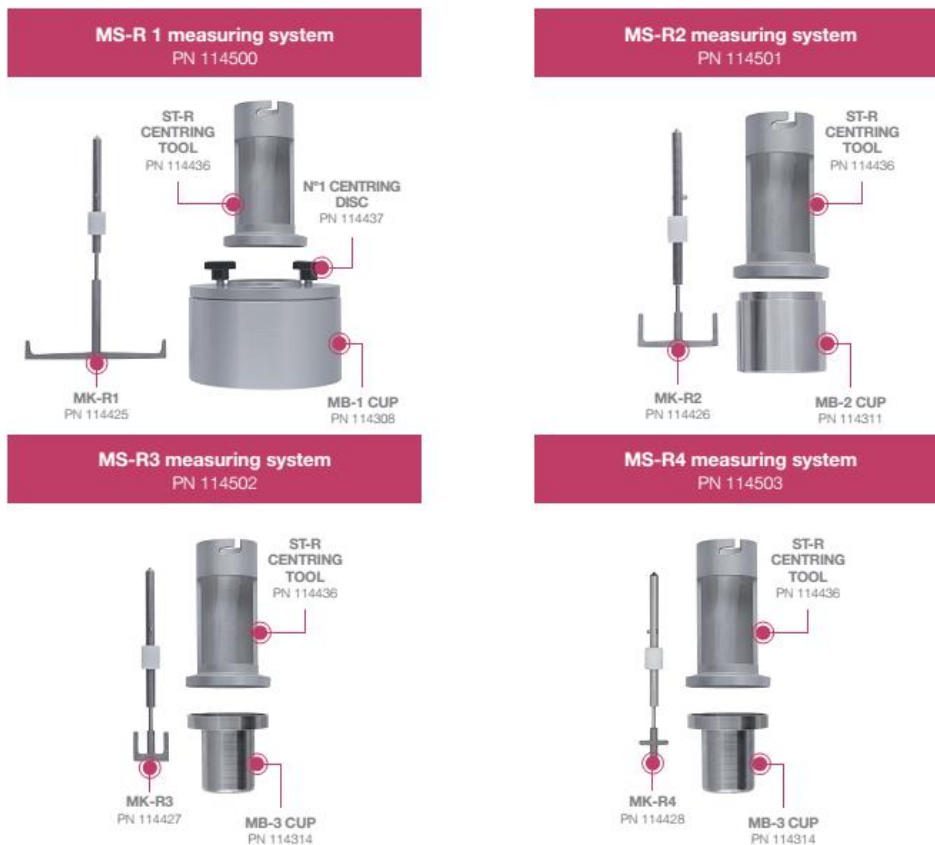

For each anchor MK-Rx there is a cup associated with it. When the assorted cup and anchor assembly is used, these measuring systems allow measures by applying a shear gradient (except for the MK-R1 system). But it is possible to use these anchors alone, in a pot for example. In this case, it is better to create a new measurement system (see section 2.6.6) using the same K_{τ} constant but setting the K_D constant to 1.

The MK-R5 can be used with cup MB-3 or MB-2 .

Here are the measurement ranges of the existing measurement systems:

Designation system	Part Number System	Part Number Complete set ^{d)}		Diameter (mm)		Sample volume (ml)	Shear rate range for RM100/RM200 /DSR500 (s ⁻¹)	Viscosity range for RM100/RM200 /DSR500 (mPa.s)
				Inner	Outer			
MS-R1 ^{c)}	114500 ^{a)}	111949	111950	93	98	300	200 rpm	1 to 40 UD
MS-R2	114501 ^{a)}			46	54	70	0.105 to 525	12 to 3.6M
MS-R3	114502 ^{a)}			23	36	25	0.09 to 450	72 to 21.6M
MS-R4	114503 ^{a)}			20	36	25	0.075 to 375	400 to 120M
MK-R5	114429 ^{b)}			5			0.03 to 150	1.5K to 475M

M for millions, K for thousand

a) Complete system (bob+cup+centring tool)

b) Only spindle. Can be use with cup MB2 (Ref. 114311) and MB3 (Ref. 114314)

c) Can be used only at 200 rpm and UD result

d) Complete set-in case with cup and centring part

All data given in this table are given for information and can be changed according container use for measurement.

As you can see in the table above, the MS-R1 system is used exclusively at 200 rpm and gives results in % UD (correspondence curve in mPa.s on request). For all other systems, the viscosity measurement will be displayed in mPa.s (Pa.s, cP or P). If you want to obtain a result in % UD (whatever the system used), you must select the MS-R75 system at 200 rpm when you set up your measurement or program (see section 2.3). Calibration curves for each mobile used are available on request for viscosity matching.

MS-R2 to MS-R5 systems can be used alone or in combination with our EVA MS-R and EVA MS DIN / MS-R temperature controls. The MS-R1 measuring system is used exclusively without temperature control.

3.9.1 MS-R without temperature control

Check that the motor has been adjusted before proceeding to the next steps (see section 2.5).

After installing the measuring head on the arm, rise it to the maximum height (see sections 1.2 and 1.5).

3.9.1.1 For systems MS-R2 to MS-R5

The first step is to place the screw on the centring tool ST-R and install it on the instrument.



The screw locks the centring piece on the base of the instrument.

You can then set up the anchor on the bayonet coupling of the instrument.



Fill the cup with your product, place it under the measuring head and lower the measuring head to place the centring piece on the cup.

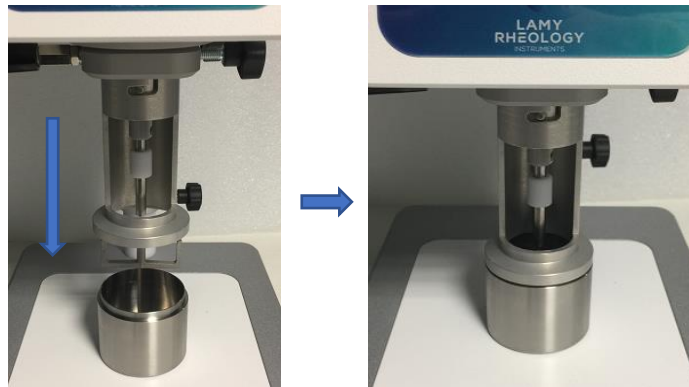

There is no need to block the height of the arm, the instrument can rest directly on the cup using the centring piece.

You can then do your measurement (see section 2.3).

Once the measurement is complete, unhook the mobile from the instrument axis and reassemble the measuring head. Remove the mobile to clean it. Also clean the temperature probe and the centring piece. It can stay in place based on the instrument for a next measurement.

3.9.1.2 For system MS-R1

The first step is to attach the cup cover MB 1 to the centring piece ST-R and the locking screw. This screw keeps the centring piece on the base of the instrument (see pictures paragraph 3.9.1.1).

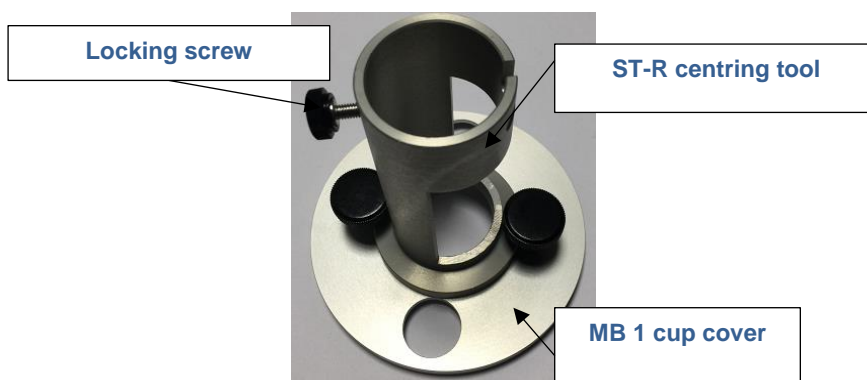

You can install the centring piece and cover assembly on the base of the instrument. Use the screw to lock the ST-R tool.

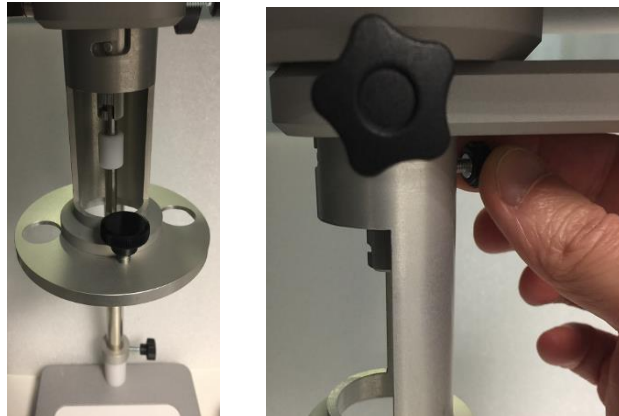

You can then set up the anchor on the bayonet coupling of the instrument.



Fill the cup with your product, place under the measuring head and lower the measuring head to place the lid on the cup.

There is no need to block the height of the arm, the instrument can rest directly on the cup using the centring piece.

You can then do your measurement (see section 2.3).

Once the measurement is complete, unhook the mobile from the instrument axis and reassemble the measuring head. Remove the mobile to clean it. Also clean the temperature probe and the centring piece. It can stay in place based on the instrument for a next measurement.

3.9.2 Utilisation with temperature control

As a reminder, only the MS-R2 to MS-R5 measuring systems can be used with the EVA temperature controls (Ref N950002, N950020, N950030, N950200 and N950210).

The measuring head must first be installed on the temperature control unit (see installation instructions supplied with the EVA temperature control).

The EVA MS-R PLUS (Ref N950200 and N950210) have 9 positions for measuring cups while the other DIN / MS-R EVA have only one. But the positioning of cups MB-2 and MB-3 is the same.

The MB-2 bucket installs directly into the EVA unit while the MB-3 bucket is to be used with the MB-2 / MB-3 ring supplied with the EVA unit.

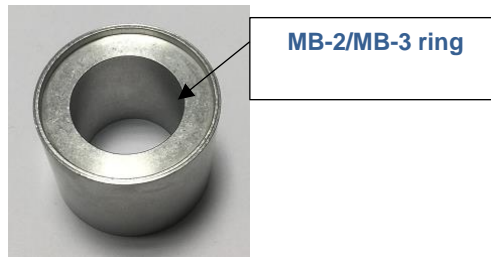

Check that the motor has been adjusted before proceeding to the next steps (see section 2.5).

For the MB-3 cup, fit the MB-2 / MB-3 ring into the EVA chamber, then insert the MB-3 bucket.

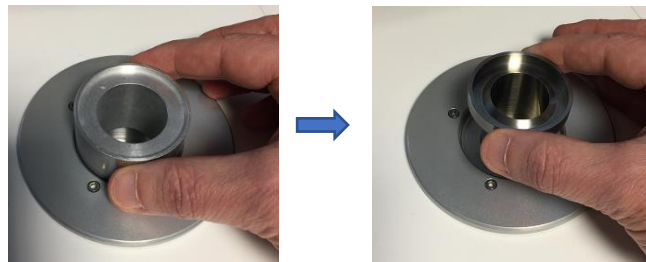

For the MB-2 cup, insert it directly into the EVA.



The placement of the centring piece and MK-R2 to MK-R5 is the same as in section 3.9.1.1. After having installed the centring piece and the MK-Rx spindle, you can lower the measuring head in this position, making sure that the centring piece covers the MB cup.

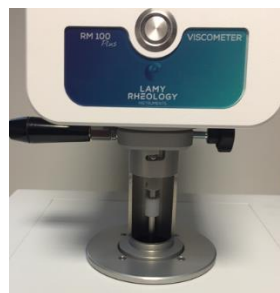

There is no need to block the height of the arm, the instrument can rest directly on the cup using the centring piece. Also, be sure to allow sufficient time for stabilization if the measurement temperature is different from the ambient temperature (at least 10 minutes) before making your measurement.

You can then do your measurement (see section 2.3).

Once the measurement is complete, unhook the mobile from the instrument axis and reassemble the measuring head. Remove the mobile to clean it. Also clean the temperature probe and the centring piece. It can stay in place based on the instrument for a next measurement.

4 VERIFICATION OF YOUR DEVICE

Your instrument is calibrated at the factory with an ASTM R2 mobile or MS DIN11 measuring system (see calibration certificate) and a certified oil with a viscosity close to 1000 mPa.s. The verification method differs depending on the measurement system selected. You may decide to perform the verification with your own measurement systems, but it is highly recommended to use one of the two measurement systems mentioned above. In case other systems are used, please contact LAMY RHEOLOGY for the most appropriate verification method.

Viscosity measurement on a 1000 mPa.s standard silicon oil with an ASTM 2555 RV2 measuring system.

- Fill the 600ml beaker with the standard oil.
- Insert the 600ml beaker in a controlled temperature unit like EVA LR system or thermostatic bath.
- Make a zero of your viscometer (see section 2.5.) if you are using standard model.
- Insert the measuring system with the bayonet coupling in the motor shaft (see section 3.1 and 3.2).
- Immerge the spindle in the oil at the good level (mark on the spindle, see section 3.2).
- Wait for 15 minutes until the standard oil rises to the good temperature.
- Select on the instrument the measuring system R2, select 50 rpm for the speed, select 60 seconds for the measuring time, and start the measurement (see section 2.3).

Viscosity measurement on a 1000 mPa.s standard silicon oil with a defined DIN11 measuring system.

- Fill the measuring tube DIN 1 with the standard oil.
- Make a zero of your viscometer (see section 2.5) if you are using standard model.
- Insert the measuring system with the bayonet coupling in the motor shaft (see section 3.1).
- Fix the tube MB-DIN1 to the viscometer (see section 3.6.1)
- Insert the measuring system in a controlled temperature unit like an EVA DIN system or CT-LC/CT-DIN with thermostatic bath.
- Wait for 10 minutes until the standard oil rises to the good temperature.
- Select on the instrument the measuring system DIN11, select 50s-1 for the speed, select 30 seconds for the measuring time, and start the measurement (see section 2.3).

Result at the end of the measurement must be within +/-5% of the standard viscosity value. If the measure is out, your instrument might need to be recalibrated.

Check if the error does not come from a wrong filling, a wrong zero adjustment, a wrong spindle rotation, or a wrong temperature value.



LAMY RHEOLOGY
11 A, rue des Aulnes
69410 Champagne au Mont d'Or (France)

Tel : 33 (0)4 78 08 54 06
Fax : 33 (0)4 78 08 69 44
contact@lamyrheology.com