

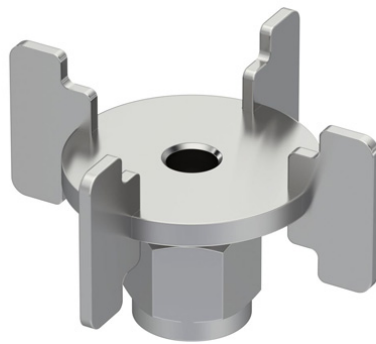

designed for scientists



HA.fb.s.2 Foam breaker 4-blade, straight

/// Hoja de Datos

Reductor de espuma para reducir la formación de espuma en el reactor. Se puede utilizar en vasos de vidrio de 2L.

IKA

designed for scientists

